

Four Pair PoE: Powering the Future of Intelligent Buildings and the IoT

Todd Frederes – CISCO

Dave Valentukonis, RCDD, NTS – SIEMON

Mark Mullins – Fluke Networks

Geoffrey Bauer, ESS – Axis Communications



2018 BICSI Fall Conference & Exhibition



Bicsi

Agenda

- **Intelligent Buildings – An Introduction to PoE**
 - Todd Frederes – CISCO
- **Cabling Systems Design and Installation Considerations**
 - Dave Valentukonis, RCDD, NTS – SIEMON
- **Testing**
 - Mark Mullins – Fluke Networks
- **End Products and Security**
 - Geoffrey Bauer, ESS – Axis Communications
- **Live Demo**
 - All



Digital Buildings: An Introduction to 4 Pair PoE

Todd Frederes



2018 BICSI Fall Conference & Exhibition



Bicsi

Agenda

- Introduction
- Overview
- Value Proposition
- Architecture
- Identification/Security
- Codes and Standards
- Deployment Example
- Summary



“Predicting rain doesn’t count; building arks does.”

- Warren Buffett



2018 BICSI Fall Conference & Exhibition



Bicsi

Generation Z'ers

Born after 1995 -

World Population Age – 42% 0-24, 20% 35-49, 14% 50-64, 8% 65+

2016 entered the workforce

66% think technology makes anything possible

80% display emotional distress if separated from devices

90% would be upset if they had to give up the Internet

51% still want to communicate to managers in person

60% want to have an impact on the world at work



2018 BICSI Fall Conference & Exhibition



Bicsi

IoT Growth

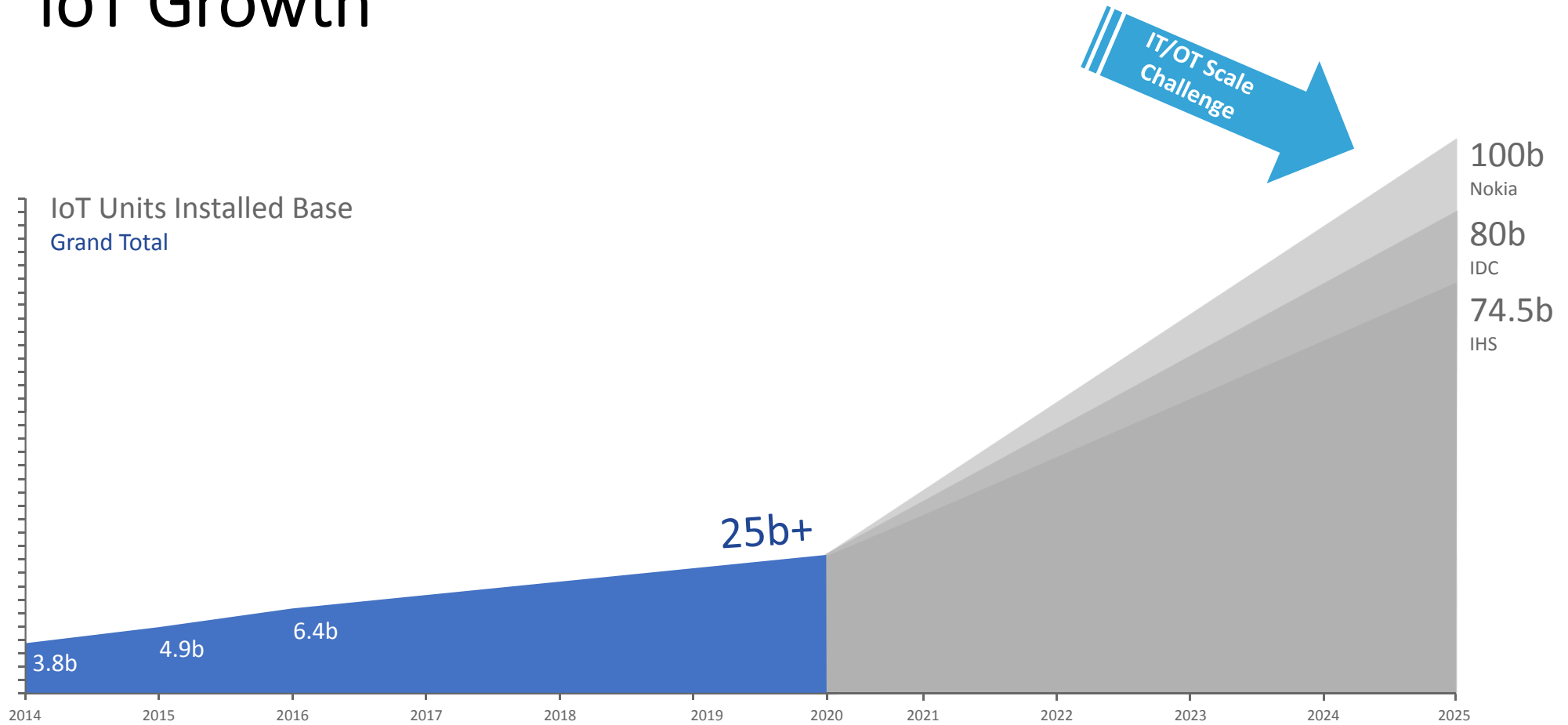

Source: <http://www.cisco.com/c/en/us/solutions/service-provider/visual-networking-index-vni/index.html>



2018 BICSI Fall Conference & Exhibition



Overview



2018 BICSI Fall Conference & Exhibition



Bicsi

Technology Has Changed Buildings.....

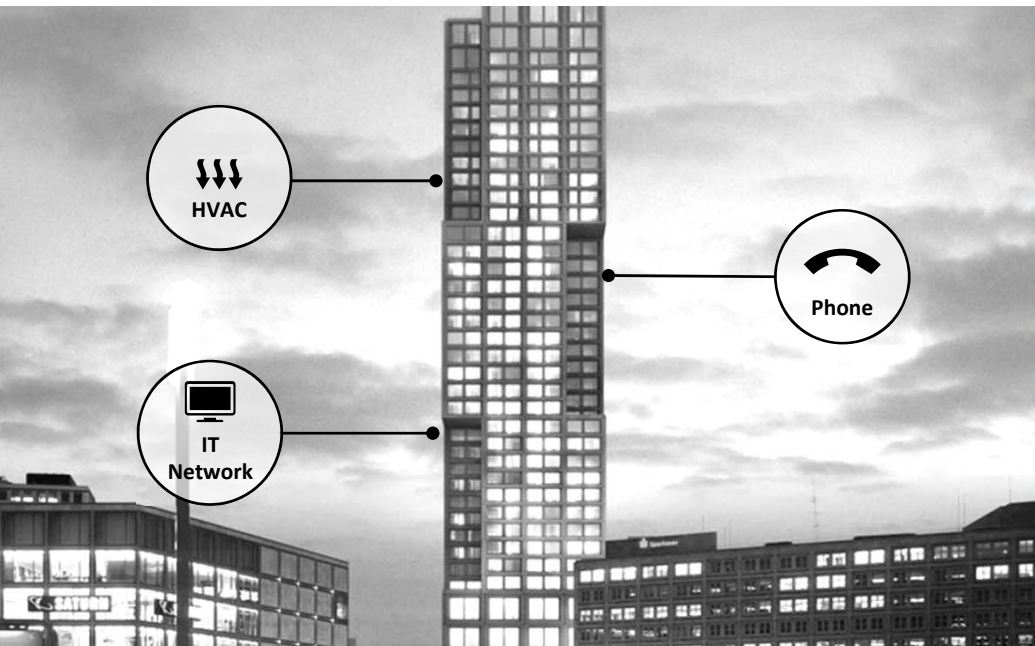

Yesterday

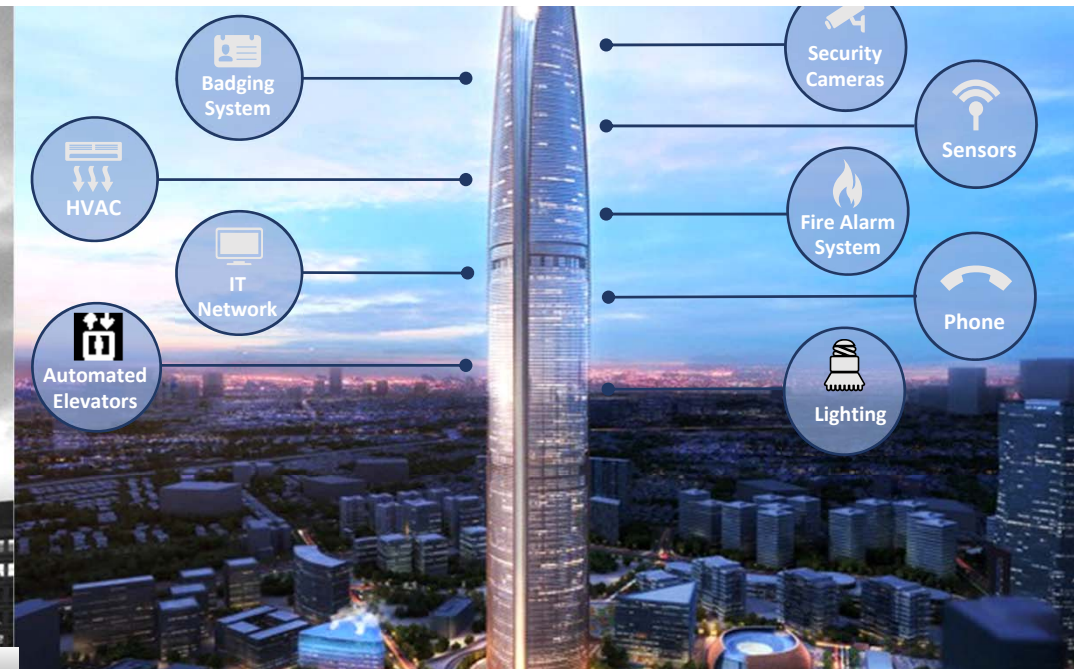

Today

Demand for new customer experiences and workforce innovation mandate improved efficiencies



2018 BICSI Fall Conference & Exhibition



Activity-Based Working (ABW) *was the first wave*

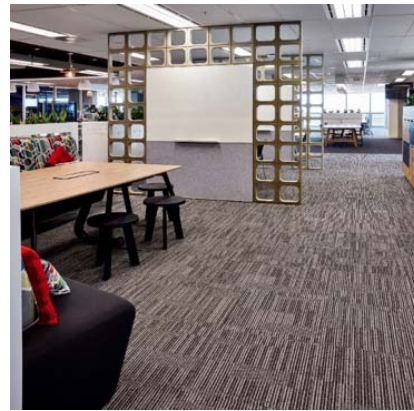

2018 BICSI Fall Conference & Exhibition



Enablers for Smart/Automated Workplace

Mobile & Digital First



Cloud / Hybrid Cloud



Virtual Assistants



AI & Machine Learning

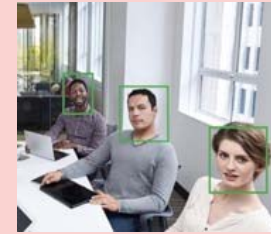

Robotic Process Automation & APIs

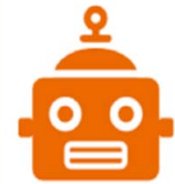

Mobility & Location Analytics



Augmented Experiences



Smart Buildings Smart Communities



IoT & Wearables



Advanced Analytics



2018 BICSI Fall Conference & Exhibition



Bicsi

IP Convergence for Digital Building Technologies

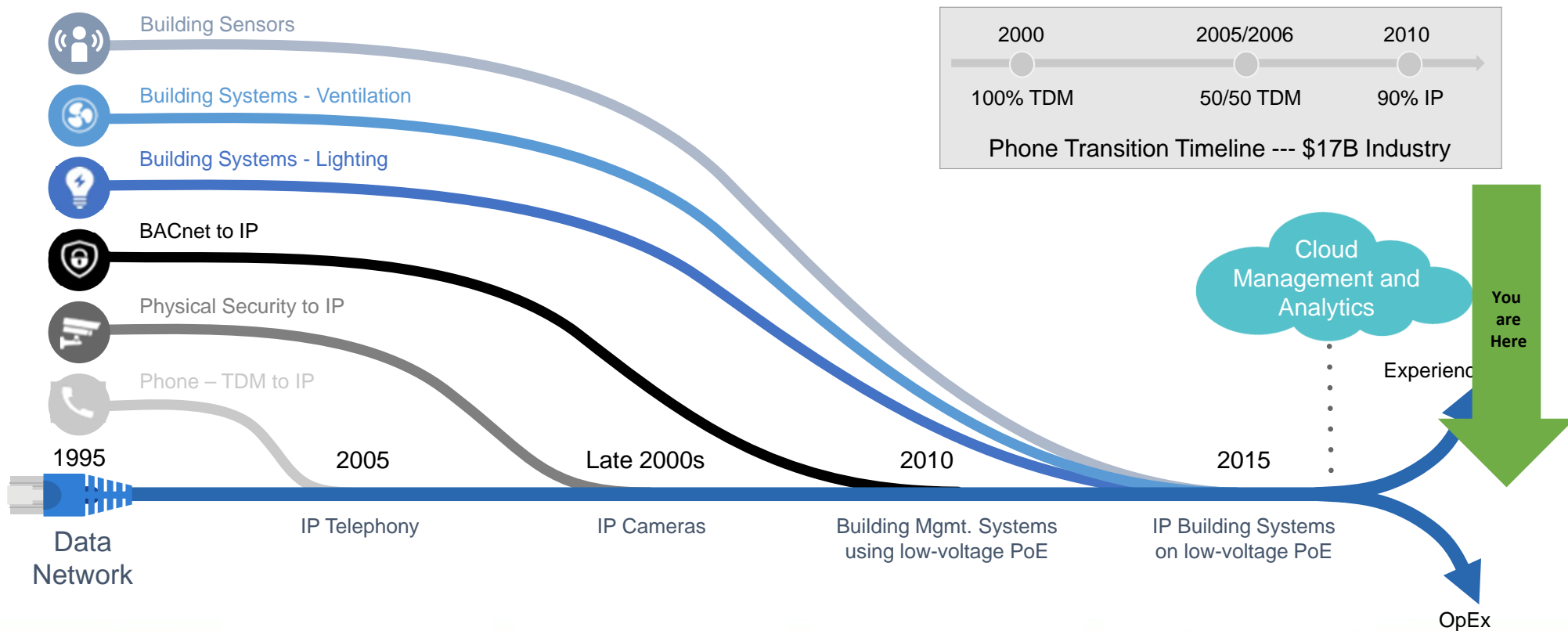

Technology is the Enabler.....

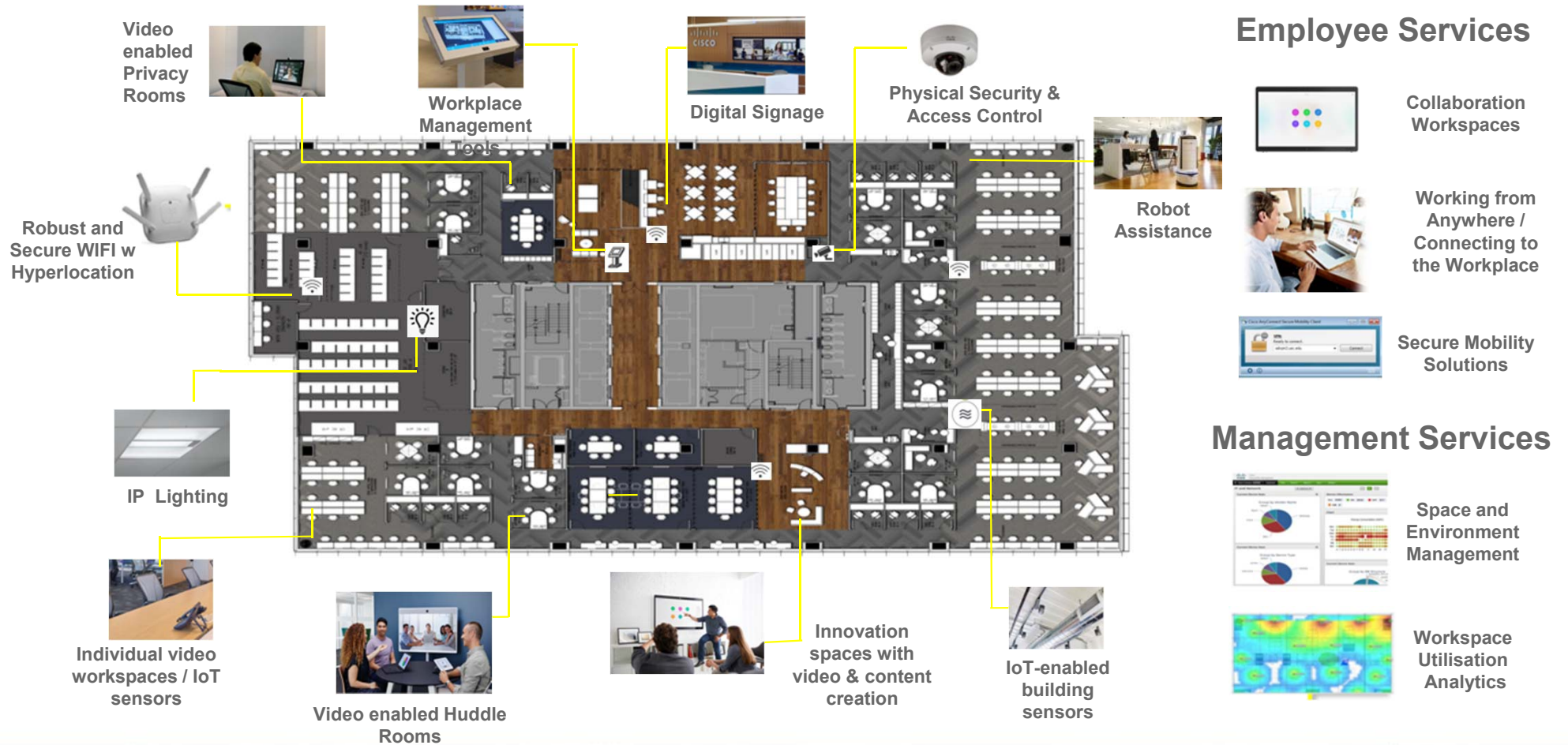

2018 BICSI Fall Conference & Exhibition



Robot Down!!



Value Proposition



2018 BICSI Fall Conference & Exhibition



Bicsi

Lower
Cost
Operations

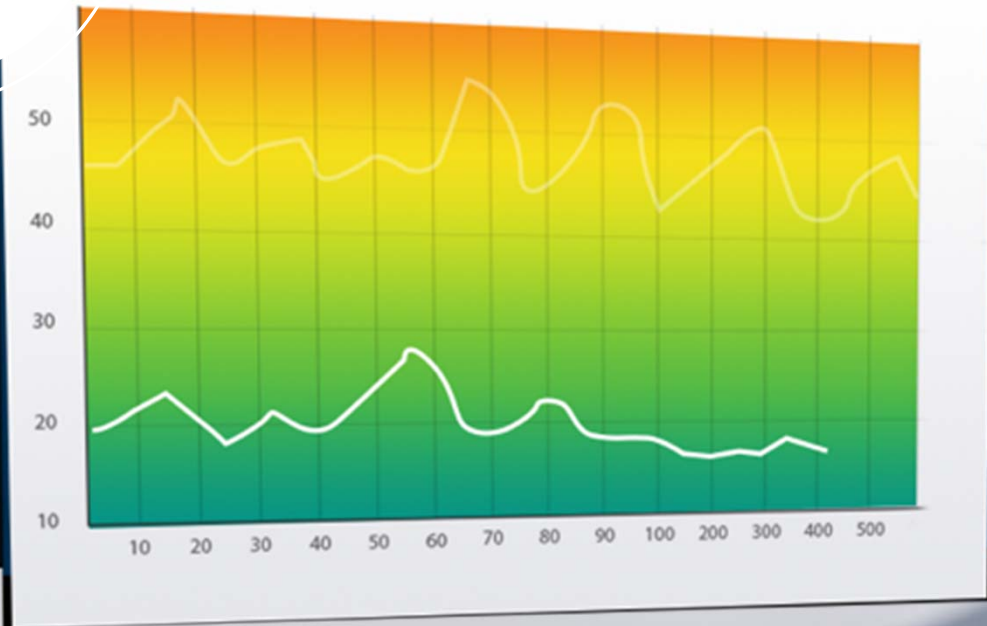

More Data

Granular, device-level Visibility and Control

Centrally Manage Via the Network

>More Energy Saving Over Traditional Methods

Save Energy, Lower Operations Costs



2018 BICSI Fall Conference & Exhibition



Bicsi

Architecture



2018 BICSI Fall Conference & Exhibition



Bicsi

Bringing it all Together

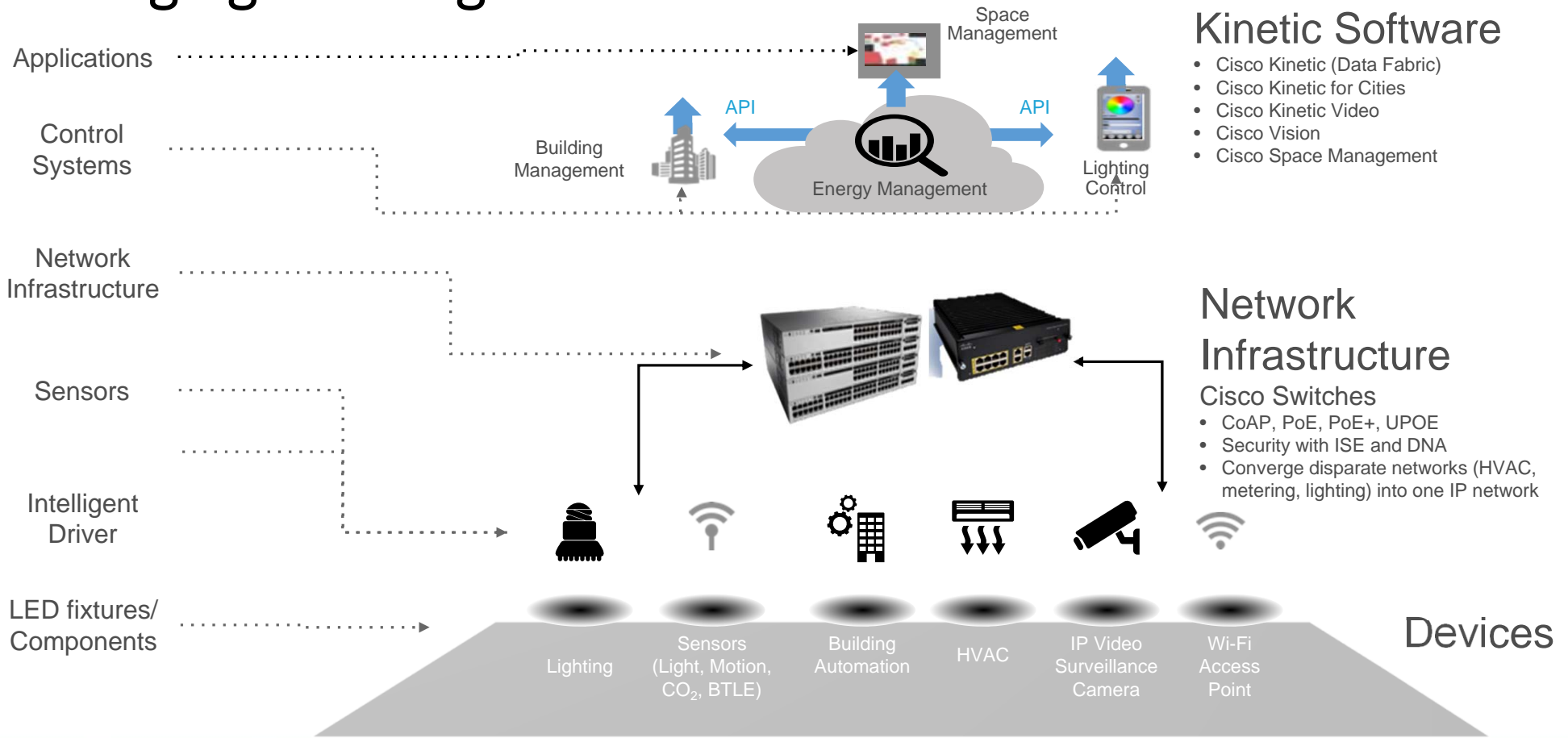

2018 BICSI Fall Conference & Exhibition



Enhanced PoE Capabilities Cisco Digital Building

UPOE supports an Expanding
Ecosystem of PoE devices

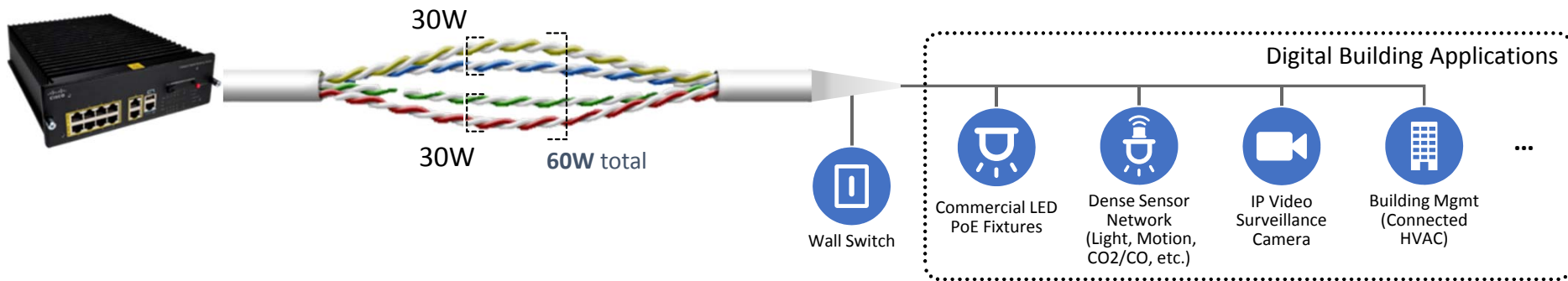

Full UPOE

- Increased PoE Budget: 480W of UPOE (8 x 60W)
- Fanless, silent reliable operation with increased MTBF and system life (10 yrs)

Perpetual UPOE

- Provides non-stop UPOE power
- Switch can continue to provide power during configuration and reboot

Fast UPOE

- Restores power to powered device within 5 secs of power resumption

2-Event Classification

- Simplified power negotiation without LLDP
- Physical layer negotiation < 1s based on class/type



2018 BICSI Fall Conference & Exhibition



Bicsi

Power Over Ethernet – IEEE 802.3af/at (Future bt)

Power over Ethernet (PoE)
Delivers DC Power and data
over a Standard Copper
Ethernet Cable(RJ45)



IEEE 802.3af/at

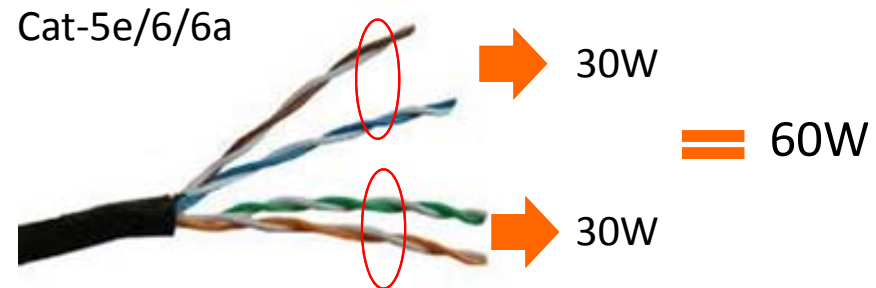

Cisco UPOE

Universal POE available since 2012

Cisco chairs IEEE 802.3bt working group
standardizing (type 3 @ 60W, type 4 @
91W)



2018 BICSI Fall Conference & Exhibition



Bicsi

DoE Cable Testing

https://www.energy.gov/sites/prod/files/2018/01/f47/cls_poe-cable-pt1_nov2017_0.pdf

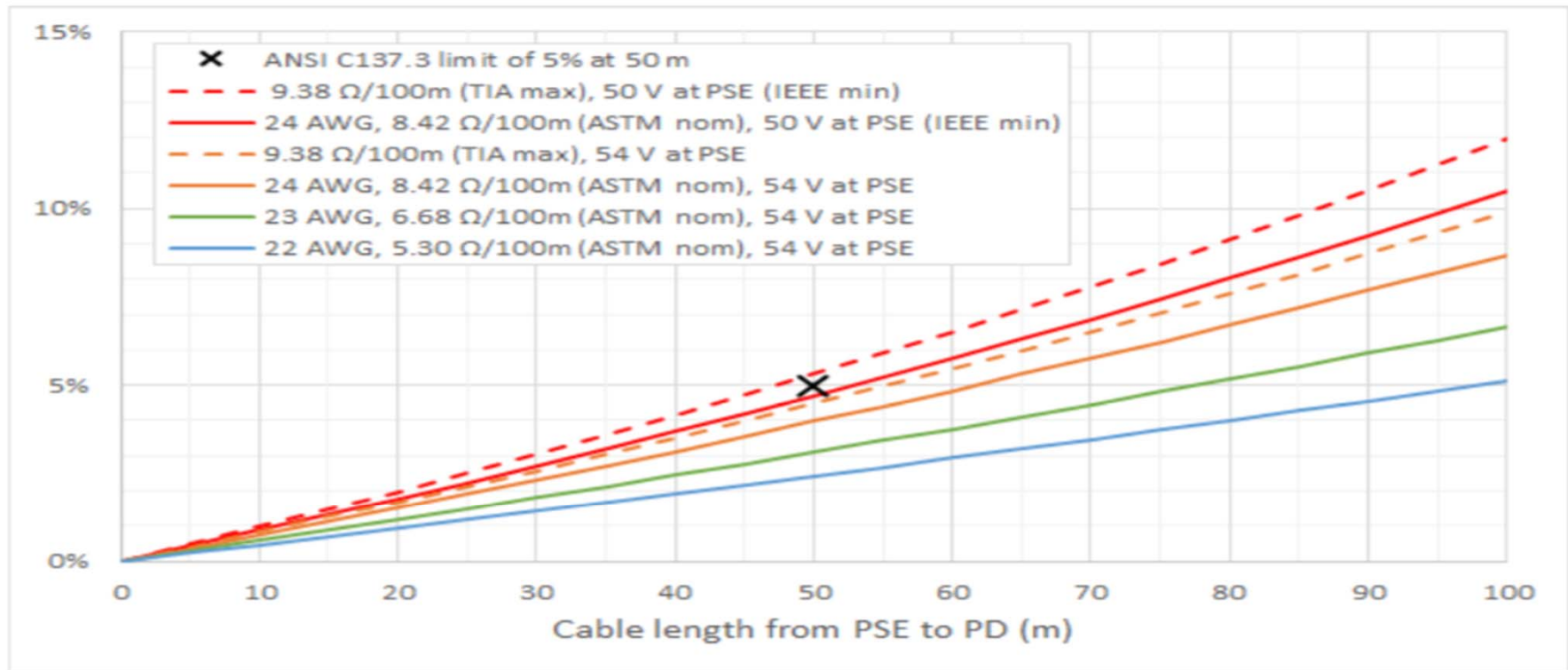

Figure 6.1. Range of expected cable losses for 51 W PD at 20°C ambient



Heat Dissipation Example

Power/Heat

Power/Heat

Power/Heat

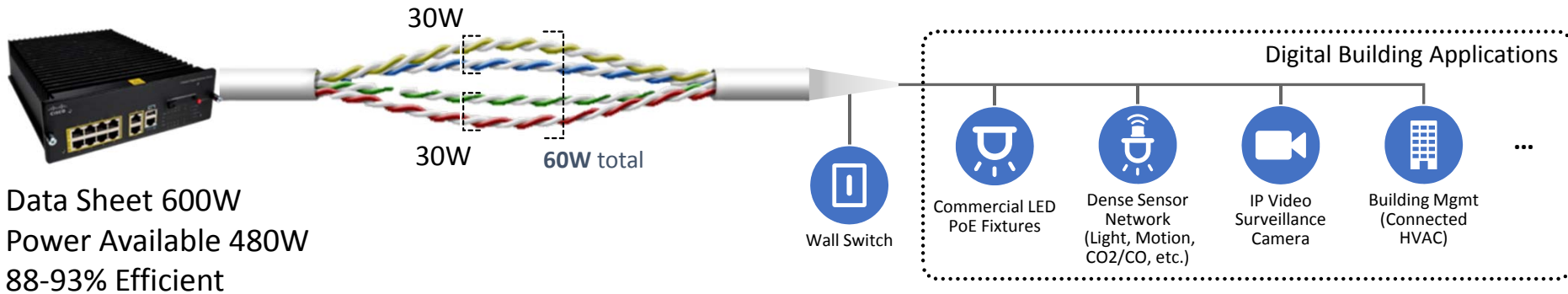

Impact at Switch

- Switch Load
- Input Power
- BTU at the Switch Small

Impact across Cable

- Wire Gauge
- Cable Length
- Bundle Size
- 1.7 – 2.8w drop @ 100M

Impact at the Powered Device

- Most of the Energy goes here

Voltage	Load	Efficiency	PF
115VAC	20%	88%	.985
115VAC	50-100%	91%	.99
230VAC	20%	89%	.84
230VAC	50-100%	93%	.96

<https://www.cisco.com/c/en/us/solutions/collateral/workforce-experience/digital-building/datasheet-c78-738206.html>



2018 BICSI Fall Conference & Exhibition



Bicsi

Mid-Span Operation

Non-Intelligent
Ethernet Switches

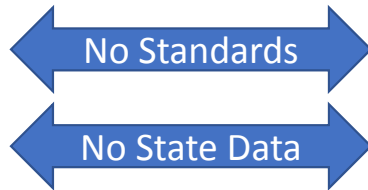

Mid-Span



Mid-Span Impact

Powered Devices (PD)

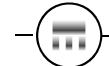

- Creates another failure point
- Do not participate in Data Channel
- Can't share power information
- Cost swap between PoE Switch and Mid-Span
- Obscures power troubleshooting



2018 BICSI Fall Conference & Exhibition



Bicsi

Existing POE Digital Building Endpoints

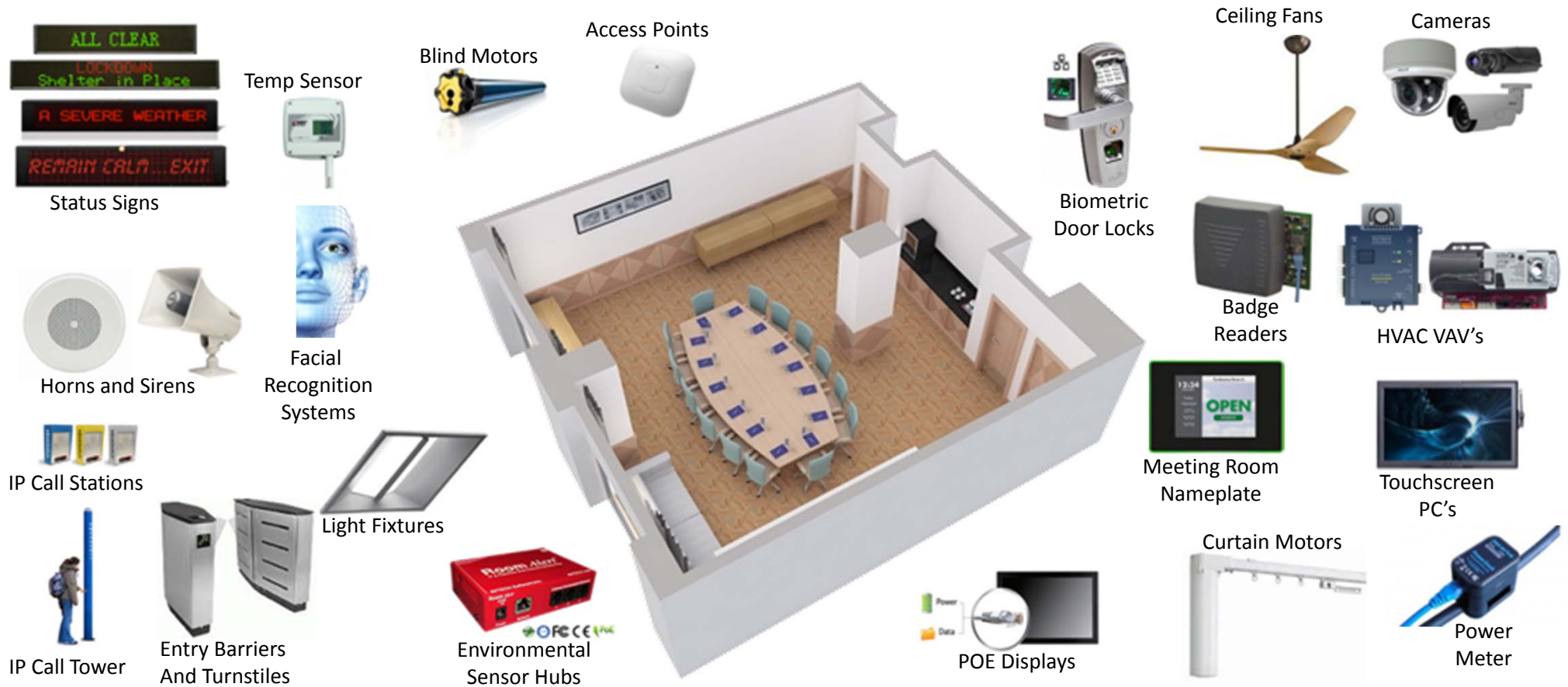

Structured Cabling Considerations



- Cable Selection – Application based
- Pathway sizing and planning
- Bundles in pathway, racks, and cabinets



Digital Building Switches have a 5x Improvement in Switch Power



Everything Active
10% Power Saving.
Efficient design, 80-Plus Gold
Power Supplies

No PoE Draw
Switch Idle Mode with up to 50%
savings

Low Ethernet Traffic
Power Savings with EEE or Energy
Efficient Ethernet

No Ethernet Traffic
Switch Hibernate Mode with up
to 75% savings



Deployment Models

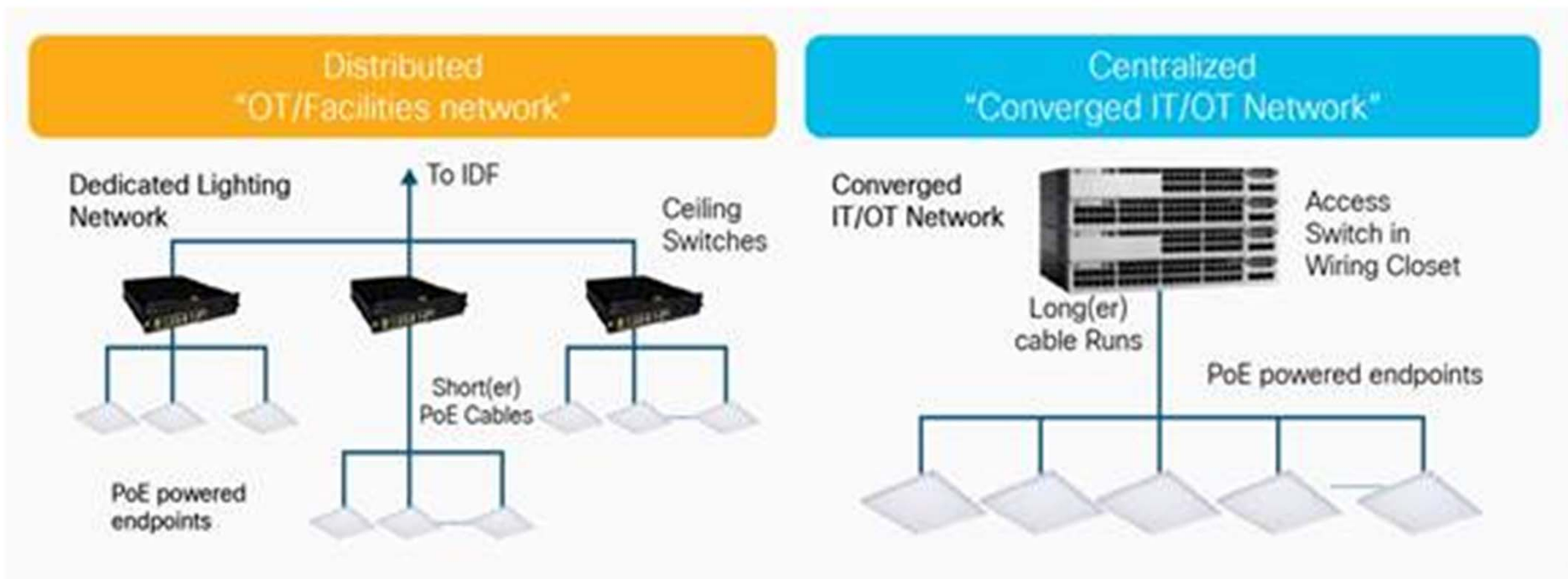

Differentiated Access Layer Approaches

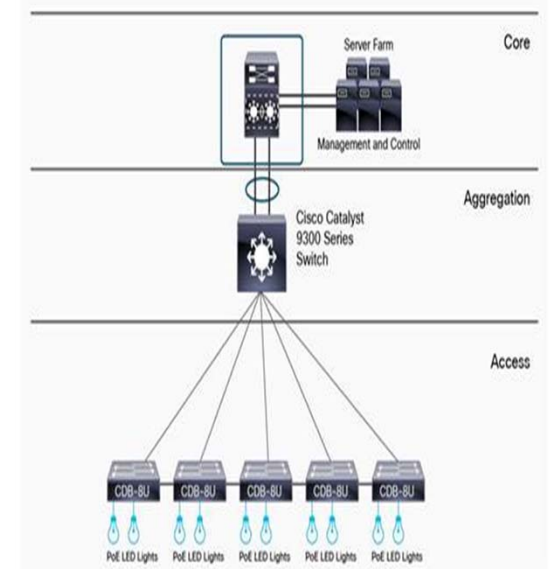
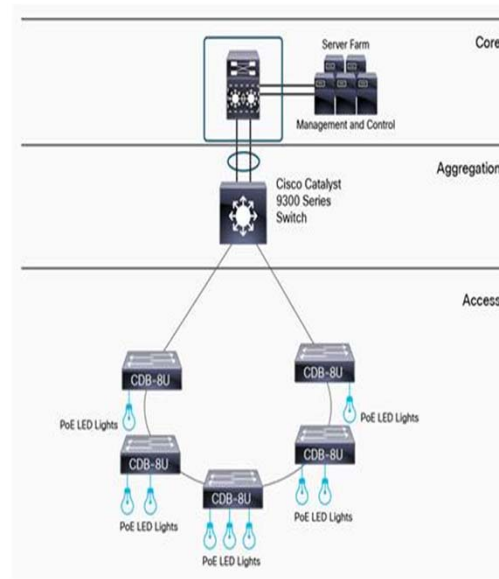
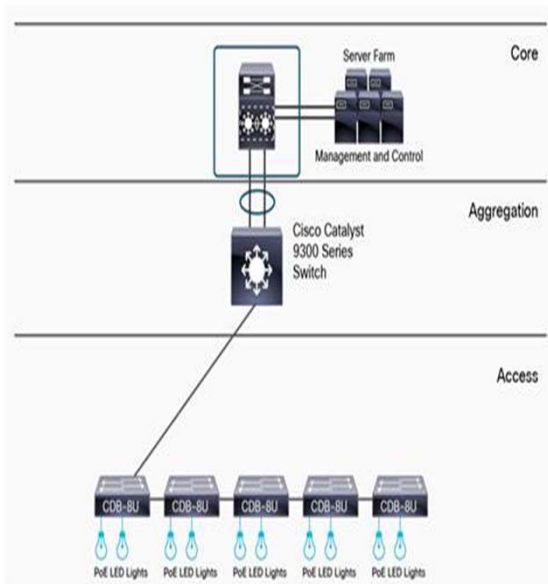

<https://www.cisco.com/c/en/us/products/collateral/switches/catalyst-digital-building-series-switches/guide-c07-740588.html>



2018 BICSI Fall Conference & Exhibition



Bicsi

Building Management Systems

Cisco Network Architecture

1 / Secure
BMS Fieldbus visible to IT and secured to prevent exploits on Enterprise infrastructure

2 / Efficient
Converged infrastructure for IT & BMS applications
BMS network is a SD-Access extension over the enterprise fabric

3 / Intelligent
Analytics combined with automation reduces time spent on troubleshooting

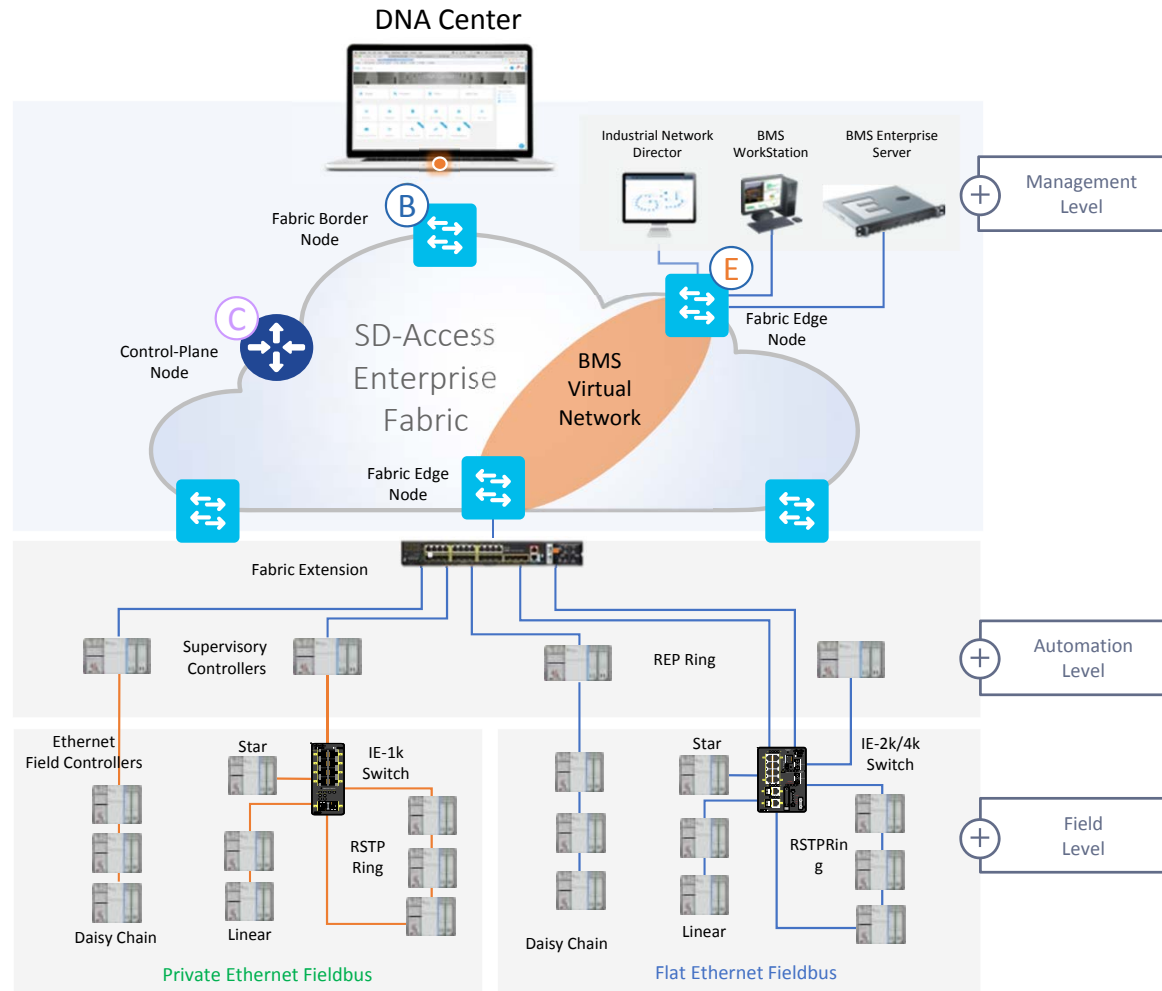

Identification/Security



2018 BICSI Fall Conference & Exhibition



Bicsi

IoT Device Business Challenges



Device Visibility

Do you know devices well enough to differentiate service?



Intent-based Policy

Does customer know behavior of devices to build their policy?



Standard based

Is there any industry standard way of connecting IoT devices to enterprise network?



2018 BICSI Fall Conference & Exhibition



Bicsi

Questions That Need Answering

What is this thing?

Who is responsible for it?

What access does it need?

Is it doing what it should be doing?

Standards Technology

- IEEE 802.11i, IEEE 802.1X, IEEE 802.1AR, EAP, ANIMA BRSKI

Products

- Industrial Network Director®, Identity Services Engine(ISE)®, DNA Center®, Switches and APs

Products

- ISE and DNA Center

Standards Technology

- **Manufacturer Usage Descriptions (MUD)**

Products

- ISE, DNA Center, the Industrial Security Appliance® (ISA), Switches and Access Points

Standards

- **MUD**, SNORT, DNS

Products

- StealthWatch®, ISA, OpenDNS Umbrella®



Benefits

Customer



- Reduces threat surface of exploding number of devices
- Almost no additional CAPEX
- Standard approach to determining manufacturer intent
- Eases and scales access management decisions

Manufacturer



- Reduces manufacturer product risk at almost no cost
- Will increase customer satisfaction and reduce support costs
- Avoids the front page
- Standards-based approach



Codes and Standards



2018 BICSI Fall Conference & Exhibition



Bicsi

ASHRAE 90.1 (Similar to IEC)

This standard provides the minimum requirements for energy-efficient design of most buildings, except low-rise residential buildings. It offers, in detail, the minimum energy-efficient requirements for design and construction of new buildings and their systems, new portions of buildings and their systems, and new systems and equipment in existing buildings, as well as criteria for determining compliance with these requirements. It is an indispensable reference for engineers and other professionals involved in design of buildings and building systems.

Recent Changes:

Building Envelope

Envelope verification in support of reduced air infiltration and increased requirements for air leakage of overhead coiling doors.

Increased stringency requirements for metal building roofs and walls, fenestration, and opaque doors.

Improved clarity on defining exterior walls, building orientation, fault assumptions for the effective R-value of air spaces, and calculation procedures for insulating metal building walls.

Lighting

Modified requirements for exterior and interior lighting power densities to reflect new lighting levels in the IES Lighting Handbook.

Modified requirements for lighting control to add additional controls in some space types and options to others to allow easier application of advanced controls.

Mechanical

Large, electrically driven chilled-water plants are now required to be monitored for electric energy use and efficiency.

Dedicated outdoor air systems now include both efficiency and rating requirements for compliance.

Requirements are introduced for designs to include both use category and efficiency class.

Requirement that air-cooled DX cooling units with economizers have a monitoring system to determine that the air economizer is working properly.



ANSI/ISA-62443 (Formerly ISA-99)

ISA/IEC-62443 is a series of standards, technical reports, and related information that define procedures for implementing electronically secure Industrial Automation and Control Systems (IACS). This guidance applies to end-users (i.e. asset owner), system integrators, security practitioners, and control systems manufacturers responsible for manufacturing, designing, implementing, or managing industrial automation and control systems.



Deployment Example



2018 BICSI Fall Conference & Exhibition



Bicsi

Marriott Sinclair Hotel (Autograph Collection)

Project Overview

- 1920's Art Deco Building in the heart of downtown Fort Worth
 - Roof Top Bar
 - Restaurant
 - High-end Spa
- Designated in the National Register of Historic Places
 - Need for minimally invasive renovations to preserve historic value
- Technology drives Customer Satisfaction and Repeat Business
 - High Speed Internet, Room Automation, Scene Control
- Low Voltage Lowers Construction Costs

Expense Category	AC Infrastructure	DC Infrastructure	
Electrical	\$2,000,000	\$1,200,000	See Note 4
Network		\$160,000	
Cabling	\$16,000	\$20,000	
VoltServer		\$150,000	
Total	\$2,016,000	\$1,530,000	
Savings		\$486,000	25.00%

- Faster Installation
- IP Enables Systems Integration and Better Management
 - Greater Energy Efficiency
 - Granular Controls
 - Enables Guest Room Automation
 - Increased Property Management Capabilities
 - Provides a Sustainable Message



Future Marriott Sinclair Hotel, Fort Worth, TX

Customer Profile Video:

<https://www.youtube.com/watch?v=uomF2xznB8>

Notes:

- 1) Inclusive of Labor and Materials for the infrastructure.
- 2) Infrastructure Powers: Lighting, Motorized Blinds/Curtains, MiniBar, TV embedded Bathroom Mirror, Door Locks, Shower Valve
- 3) Device Costs (AC/POE comparable)
- 4) DC Infrastructure Electrical Costs include backup AC Outlet for Minibar and Bathroom Mirror in case that POE versions are not ready in construction timeline. **An additional \$200,000 savings (yielding 35% Savings over AC Infrastructure) would be had if these electrical circuits were not installed.**
- 5) Building Electrical service changed from 4000A service to 2500A service.



2018 BICSI Fall Conference & Exhibition



CompuCom Digital Campus Charlotte, NC
Leveraging Technology and Innovation to Drive Collaboration,
Productivity and Operational Efficiency

Challenge

- Enable a vision of the modern workplace
- Meet construction deadlines
- Incubate and advance digital workplace technologies and services

Solution Implemented

- Cisco's Digital Building Switches
- PoE Lighting
- Ethernet Building Field Controllers
- Extensive Cisco Collaboration, Networking, Wireless
- PoE Access Control and Physical Security

Results

- Tree's to keys in under 12 months
- Reduced Labor by two-thirds saving \$275,000
- 16% less expensive overall per square foot than previous project

<https://www.compucom.com/news/compucom-unveils-new-digital-campus-headquarters>



Summary



2018 BICSI Fall Conference & Exhibition



Bicsi

Digital Transformation Must Be Part of Your Building and Cities Strategy



- Buildings and Cities are changing
 - IT and OT teams need to work together
 - Buildings and Cities are become digital
- Digital Transformation is essential in the Communities of the Future
- The Smart Infrastructure will be play a major role
- Talk to new people!!
- Build an Ark, Change the world!!





2018 BICSI Fall Conference & Exhibition



Cabling for Remote Powering

Dave Valentukonis, RCDD/NTS
Siemon



2018 BICSI Fall Conference & Exhibition



Bicsi

Agenda

- Remote Powering
- Impact on Cabling
- Intelligent Buildings
- Converged Cabling Designs



Remote Powering

- Running power concurrent to data over structured cabling
- Over 100 million PoE enabled ports are shipping annually
- Annual Wi-Fi enabled router shipments will soon exceed 200 million
 - Power over Ethernet (PoE) is the preferred powering method



UPOE compatible Cisco Catalyst 4500E Series Switching platform



Cost Savings with PoE

- The cost of a power outlet includes conduit, wire, a back box for the outlet and the labor of an electrician
 - The average cost to provide typical power to a device is about \$1,000
 - The average cost of a PoE network port plus the structured cable drop is \$250 per drop



2018 BICSI Fall Conference & Exhibition



Bicsi

Quiz Question #1

What is are the four current and pending IEEE PoE power levels (W)?

A: 15, 30, 60, 90



2018 BICSI Fall Conference & Exhibition



Bicsi



IEEE P802.3bt

- Physical Layer and Management Parameters for DTE Power via MDI over 4-Pair
- Employs four balanced twisted-pairs to deliver remote power
 - Improves efficiency
 - Increases power
- Introduces Type 3 ($\geq 60\text{W}$ at the PSE output) and Type 4 ($\geq 90\text{W}$ at the PSE output) technologies
- Supports operation with 10GBASE-T
- Operation over category 5e or higher cabling
- Target Publication: [September 2018](#)



Existing and Emerging Applications

	Minimum Power at PSE Output	Number of Pairs	Maximum Current per Pair
Power over Ethernet (Type 1)	15.4 W	2-pairs	350 mA
Power over Ethernet Plus (Type 2)	30.0 W	2-pairs	600 mA
4-pair PoE ¹ (Type 3)	60.0 W	4-pairs	600 mA
4-pair PoE ¹ (Type 4)	90.0 W	4-pairs	960 mA
Power over HDBase-T (POH)	100.0 W	4-pairs	960 mA

¹ Under development via IEEE 802.3bt



Agenda

- Remote Powering
- Impact on Cabling
- Intelligent Buildings
- Converged Cabling Designs



Implications of Remote Powering

1. Heat builds-up within cable bundles
2. Bundle sizes may need to be reduced to improve heat dissipation
3. Overall channel length may need to be reduced to offset increased insertion loss resulting from a higher operating temperature
4. Contact arcing occurs when un-mating pairs under load and may affect connecting hardware reliability

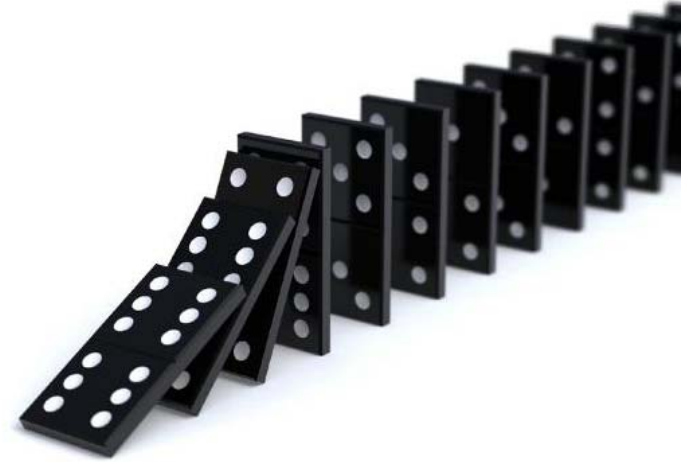

Quiz Question #2

What is the TIA specified operating temperature range for cabling?

A: -20°C to 60°C (-4°F to 140°F)



2018 BICSI Fall Conference & Exhibition



Bicsi

Temperature Rise Considerations

- Remote powering can cause heat build-up within cable bundles
- Cabling insertion loss increases at temperatures above 20°C/68°F
- The temperature of any cable should not exceed the temperature rating for the cable
 - Generally, cables used in commercial premises have a temperature rating of 60°C
 - Exceeding a cable's specified operating temperature may result in long term cable degradation
 - Cables with higher temperature ratings are listed and marked accordingly
 - Exceeding 60°C/140°F DOES NOT result in cables melting or safety risks

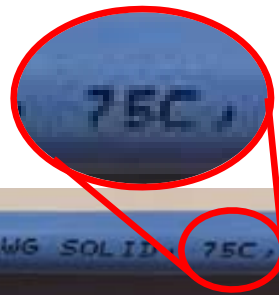

SIEMON CATEGORY 6A, TIA-568-C.2, ISO/IEC 11801, IEC 61156-5, 9A6P4-R5, 4-PR, F/UTP, 23 AWG SOLID, 75C



2018 BICSI Fall Conference & Exhibition



Bicsi

It's not getting colder...

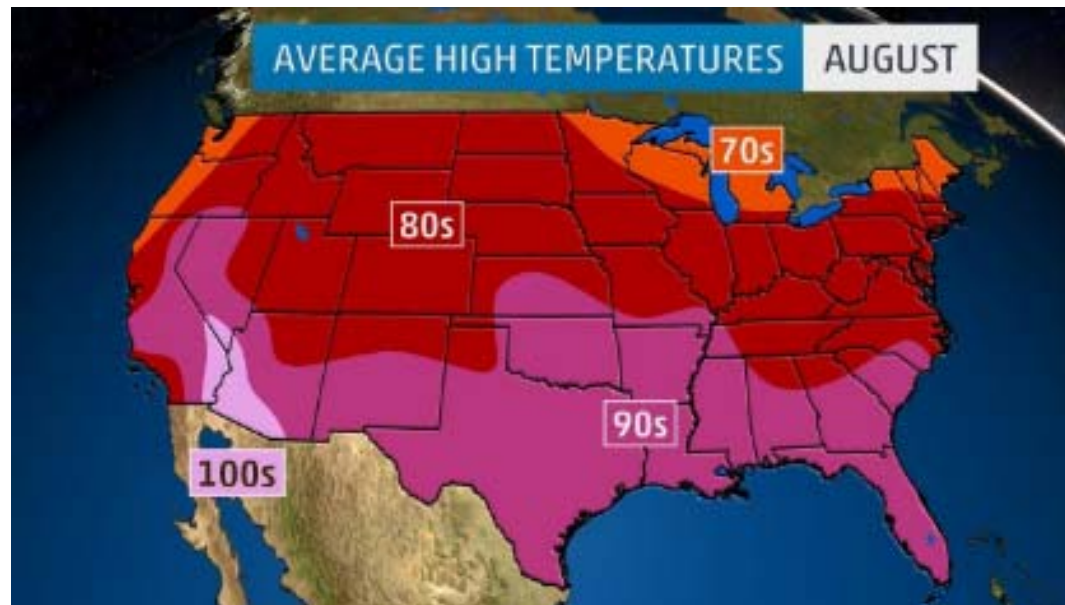

Source: The Weather Channel



2018 BICSI Fall Conference & Exhibition



PoE Cable Temperature Rise

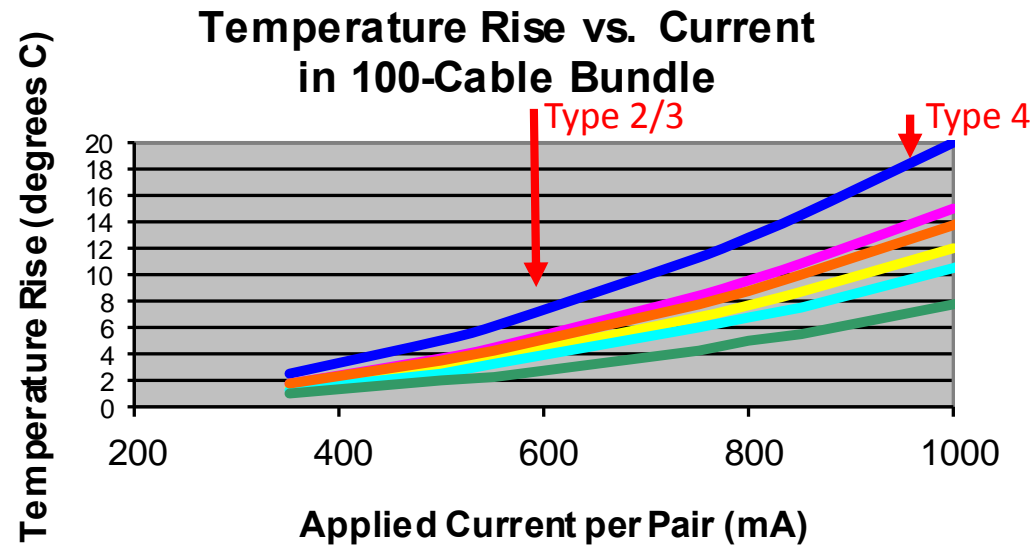

Channel Length De-Rating

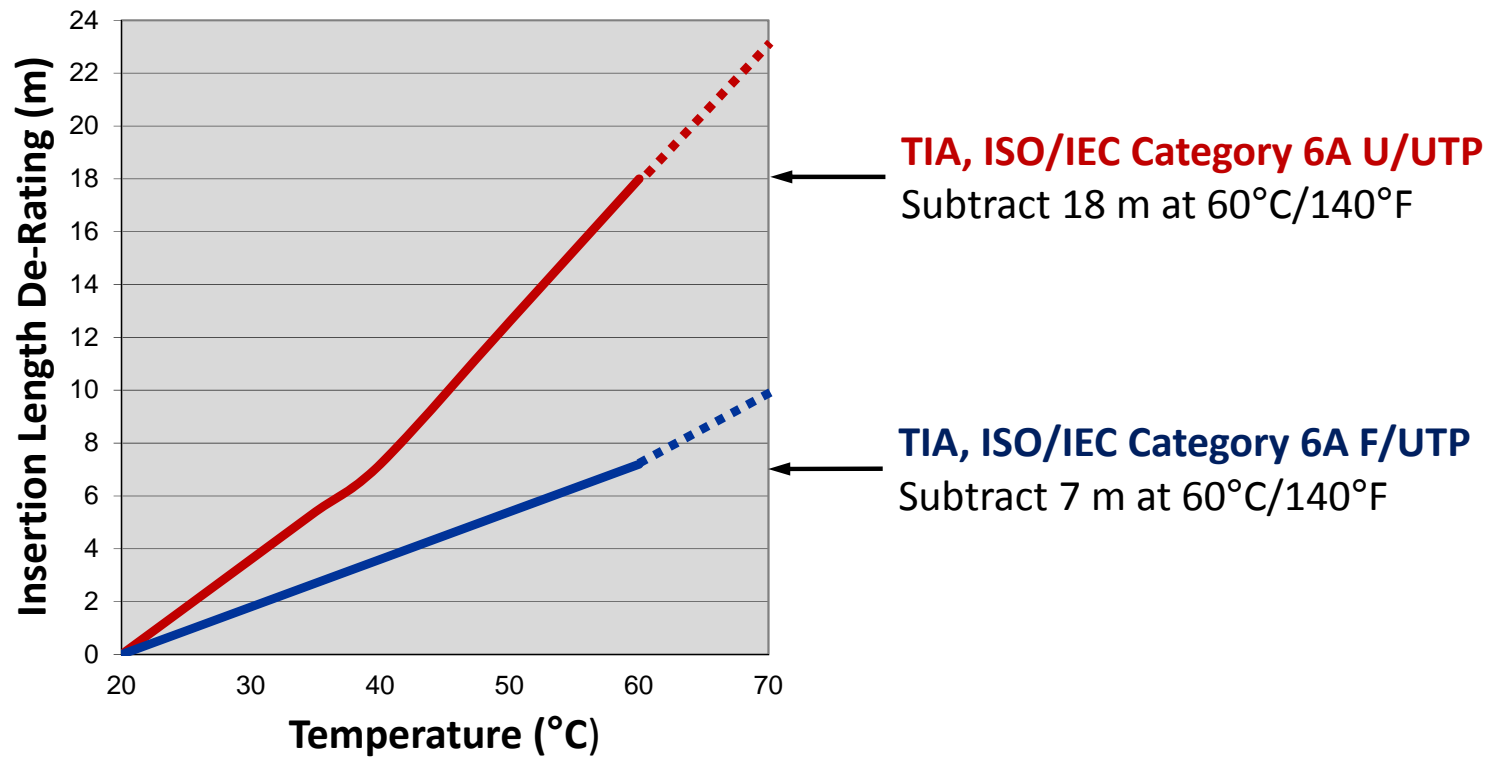

Potential for Arcing Under Load Conditions

- Remote powering applications do not apply DC power until a PD is sensed by the PSE
- Device disconnections can't be anticipated
- “Un-mating pairs under load” produces an arc as the applied current transitions from flowing through conductive metal to air before becoming an open circuit
- Arcing can result in corrosion and pitting damage on the plated contact surface at the arcing location

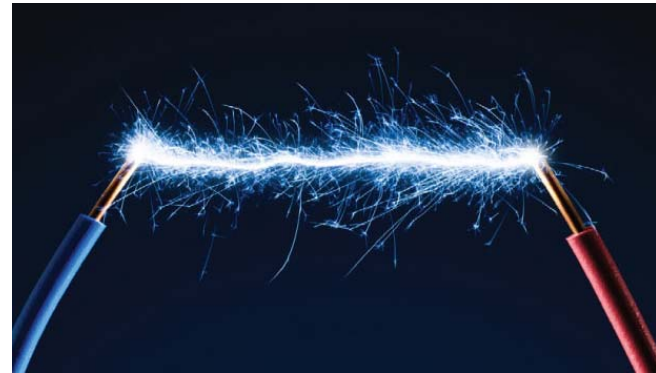

Ensuring Contact Integrity

- Informative Annex B of TSB-184-A contains the following guidance:
 - Connecting hardware having the required performance for mating and un-mating under the relevant levels of electrical power and load should be chosen
 - IEC 60512-99-001 is referenced as a suitable test schedule

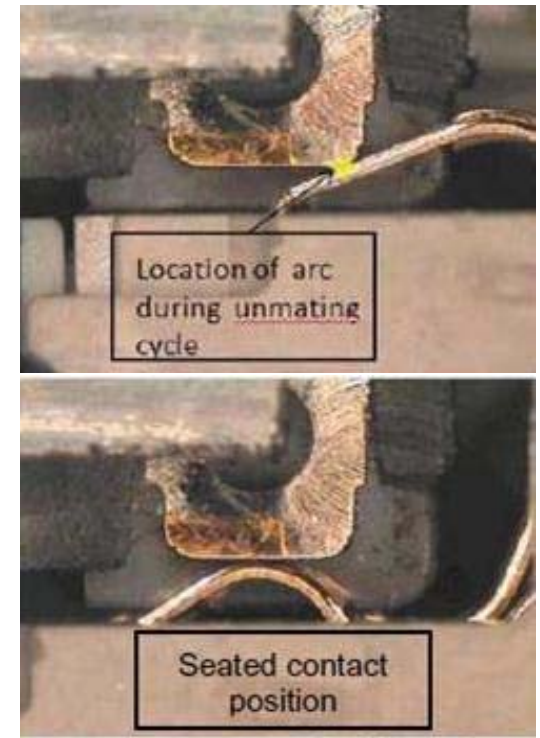

Standards Resources

- NFPA 70 (2017 NEC)
- TIA TSB-184-A-2017
- TIA-569-D-2-2018



2017 NEC Code Revisions

- Cable Ratings and Markings for Safety
- Ampacity Table for Bundles

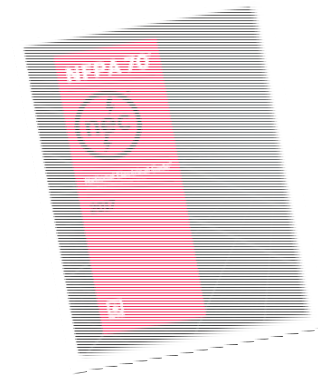

Part VI. Premises Powering of Communications Equipment over Communications Cables

840.160 Powering Circuits. Communications cables, in addition in carrying the communications circuit, shall also be permitted to carry circuits for powering communications equipment. Where the power supplied over a communications cable to communications equipment is **greater than 60 watts**, communication cables and the power circuit shall comply with 725.144 where communications cables are used in place of Class 2 and Class 3 cables.



2017 NEC Table 725.144

- Conductor gauge, bundle size and temperature rating are used to establish a safe power rating (Ampacity) for each conductor

AWG	Number of 4-Pair Cables in a Bundle																				
	1			2-7			8-19			20-37			38-61			62-91			92-192		
	Temp Rating			Temp Rating			Temp Rating			Temp Rating			Temp Rating			Temp Rating					
	60°C	75°C	90°C	60°C	75°C	90°C	60°C	75°C	90°C	60°C	75°C	90°C	60°C	75°C	90°C	60°C	75°C	90°C	60°C	75°C	90°C
26	1	1	1	1	1	1	0.7	0.8	1	0.5	0.6	0.7	0.4	0.5	0.6	0.4	0.5	0.6	NA	NA	NA
24	2	2	2	1	1.4	1.6	0.8	1	1.1	0.6	0.7	0.9	0.5	0.6	0.7	0.4	0.5	0.6	0.3	0.4	0.5
23	2.5	2.5	2.5	1.2	1.5	1.7	0.7	1.1	1.2	0.6	0.8	0.9	0.5	0.7	0.8	0.5	0.7	0.8	0.4	0.5	0.6
22	3	3	3	1.4	1.8	2.1	1	1.2	1.4	0.7	0.9	1.1	0.6	0.9	1.1	0.6	0.8	0.9	0.5	0.6	0.7



Example: Can this cable support Type 4 PoE?

- 24 AWG category 5e cable
- Bundle size of 75 cables
- Mechanically rated to 60°C

AWG	Number of 4-Pair Cables in a Bundle																				
	1			2-7			8-19			20-37			38-61			62-91			92-192		
	Temp Rating			Temp Rating			Temp Rating			Temp Rating			Temp Rating			Temp Rating					
	60°C	75°C	90°C	60°C	75°C	90°C	60°C	75°C	90°C	60°C	75°C	90°C	60°C	75°C	90°C	60°C	75°C	90°C	60°C	75°C	90°C
26	1	1	1	1	1	1	0.7	0.8	1	0.5	0.6	0.7	0.4	0.5	0.6	0.4	0.5	0.6	NA	NA	NA
24	2	2	2	1	1.4	1.6	0.8	1	1.1	0.6	0.7	0.9	0.5	0.6	0.7	0.4	0.5	0.6	0.3	0.4	0.5
23	2.5	2.5	2.5	1.2	1.5	1.7	0.7	1.1	1.2	0.6	0.8	0.9	0.5	0.7	0.8	0.5	0.7	0.8	0.4	0.5	0.6
22	3	3	3	1.4	1.8	2.1	1	1.2	1.4	0.7	0.9	1.1	0.6	0.9	1.1	0.6	0.8	0.9	0.5	0.6	0.7



Alternatives

1. Use cables with a larger conductor or higher mechanical rating
2. Reduce bundle size

AWG	Number of 4-Pair Cables in a Bundle																				
	1			2-7			8-19			20-37			38-61			62-91			92-192		
	Temp Rating			Temp Rating			Temp Rating			Temp Rating			Temp Rating			Temp Rating					
	60°C	75°C	90°C	60°C	75°C	90°C	60°C	75°C	90°C	60°C	75°C	90°C	60°C	75°C	90°C	60°C	75°C	90°C	60°C	75°C	90°C
26	1	1	1	1	1	1	0.7	0.8	1	0.5	0.6	0.7	0.4	0.5	0.6	0.4	0.5	0.6	NA	NA	NA
24	2	2	2	1	1.4	1.6	0.8	1	1.1	0.6	0.7	0.9	0.5	0.6	0.7	0.4	0.5	0.6	0.3	0.4	0.5
23	2.5	2.5	2.5	1.2	1.5	1.7	0.7	1.1	1.2	0.6	0.8	0.9	0.5	0.7	0.8	0.5	0.7	0.8	0.4	0.5	0.6
22	3	3	3	1.4	1.8	2.1	1	1.2	1.4	0.7	0.9	1.1	0.6	0.9	1.1	0.6	0.8	0.9	0.5	0.6	0.7



TIA TSB-184-A

- *Guidelines for Supporting Power Delivery Over Balanced Twisted-Pair Cabling* (March 2017)
- The standard presumes a maximum ambient temperature of 45°C/113°F in conjunction with cabling with a maximum rating of 60°C/140°F, thus allowing a maximum temperature rise of 15°C/27°F on any cable within the bundle due to dc powering
 - The maximum ambient temperature along the link (length of at least 1m) should be used as the basis for the calculation

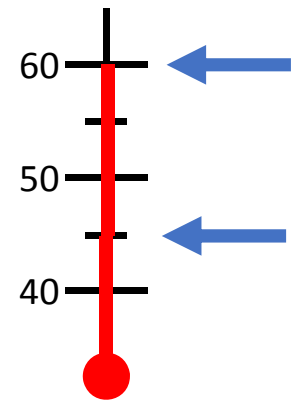

Mitigation Recommendations

- Use Category 6A or higher-performing 4-pair balanced twisted-pair cabling
- Install shielded cables
- Reduce channel length, as necessary, to offset increased insertion loss
- Minimize cable lengths in order to reduce dc loop resistance

AWG	Ohms/100m (solid)
23	7.32
24	9.38
26	14.8



Mitigation Recommendations

- Leave cables unbundled
 - If bundling, smaller bundles are recommended

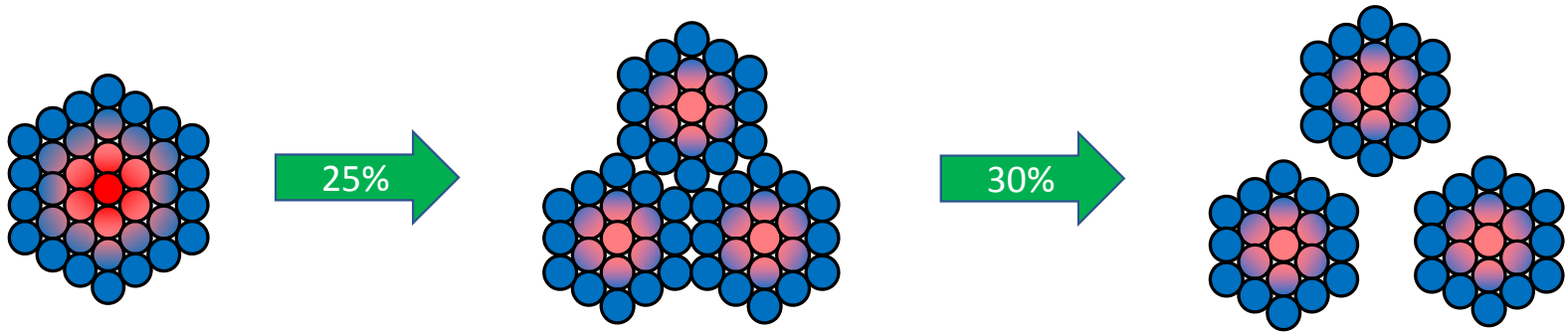

- Limit the number of cables per bundle to 24



Cable Bundle Recommendations

- When in doubt about cable mechanical or heat dissipation capability, installation environment, or remote powering application, a conservative practice is to limit maximum bundle size to **24** cables

AWG	Number of 4-Pair Cables in a Bundle																				
	1			2-7			8-19			20-37			38-61			62-91			92-192		
	Temp Rating			Temp Rating			Temp Rating			Temp Rating			Temp Rating			Temp Rating					
	60°C	75°C	90°C	60°C	75°C	90°C	60°C	75°C	90°C	60°C	75°C	90°C	60°C	75°C	90°C	60°C	75°C	90°C	60°C	75°C	90°C
26	1	1	1	1	1	1	0.7	0.8	1	0.5	0.6	0.7	0.4	0.5	0.6	0.4	0.5	0.6	NA	NA	NA
24	2	2	2	1	1.4	1.6	0.8	1	1.1	0.6	0.7	0.9	0.5	0.6	0.7	0.4	0.5	0.6	0.3	0.4	0.5
23	2.5	2.5	2.5	1.2	1.5	1.7	0.7	1.1	1.2	0.6	0.8	0.9	0.5	0.7	0.8	0.5	0.7	0.8	0.4	0.5	0.6
22	3	3	3	1.4	1.8	2.1	1	1.2	1.4	0.7	0.9	1.1	0.6	0.9	1.1	0.6	0.8	0.9	0.5	0.6	0.7



Mitigation Recommendations

- Use open wire tray or similar cable management that provides for largely unrestricted airflow around the installed cables
 - Disperse cables evenly across the width of the tray
- Reduce maximum operating temperature
- Mix unpowered cables with powered cables



TIA-569-D-2-2018

- *Additional Pathway and Space Considerations for Supporting Remote Powering Over Balanced Twisted-Pair Cabling* (July 2018)
- Pathways differ in regard to geometry and contact area between cables, pathway, and air
- Provides general guidance on heat dissipation of various pathways by bundle size



2018 BICSI Fall Conference & Exhibition



Bicsi

Pathway Type	Cable Routing	Cable Quantity			
		1-37	38-61	62-91	> 91
Non-continuous	Bundled	High	High	High	N/A
	Unbundled	High	High	High	N/A
Conduit (Metallic & Non-metallic)	Bundled	Low	Low	Low	Low
	Unbundled	Medium	Low	Low	Low
Sealed Conduit	Bundled	Low	Low	Low	Low
	Unbundled	Low	Low	Low	Low

Tray Type	Fill Depth (in.)		
	1	2	≥ 3
Wire Mesh/Ladder	High	High	High
Ventilated	High	Medium	Low
Unventilated	Medium	Medium	Low



Agenda

- Remote Powering
- Impact on Cabling
- Intelligent Buildings
- Converged Cabling Designs



Planning for Intelligent Buildings

- Design 10-15 years out
 - Allow for additional systems and cabling
 - Plan for future builds
 - Accommodate future applications



Quiz Question #3

What is the TIA standard for the Structured Cabling Infrastructure Standard for Intelligent Building Systems?

A: ANSI/TIA-862-B-2016



2018 BICSI Fall Conference & Exhibition



Bicsi

Quiz Question #4

What is the BICSI standard for the Information Communication Technology Design and Implementation Practices for Intelligent Buildings and Premises?

A: BICSI 007-2017



2018 BICSI Fall Conference & Exhibition



Bicsi

Meeting Applicable Codes & Standards

- ANSI/TIA-862-B “Structured Cabling Infrastructure Standard for Intelligent Building Systems”
- BICSI 007-2017, “Information Communication Technology Design and Implementation Practices for Intelligent Buildings and Premises”



TIA-862-B-2016

- *Structured Cabling Infrastructure Standard for Intelligent Building Systems*
 - Change of title (was Building Automation Systems Cabling Standard)
- General substitution of the term “intelligent building system” for the previous term “building automation system”
- Addition of guidance for cabling for:
 - Wireless systems
 - Remote powering over balanced twisted-pair cabling
 - Smart lighting



Topology Options

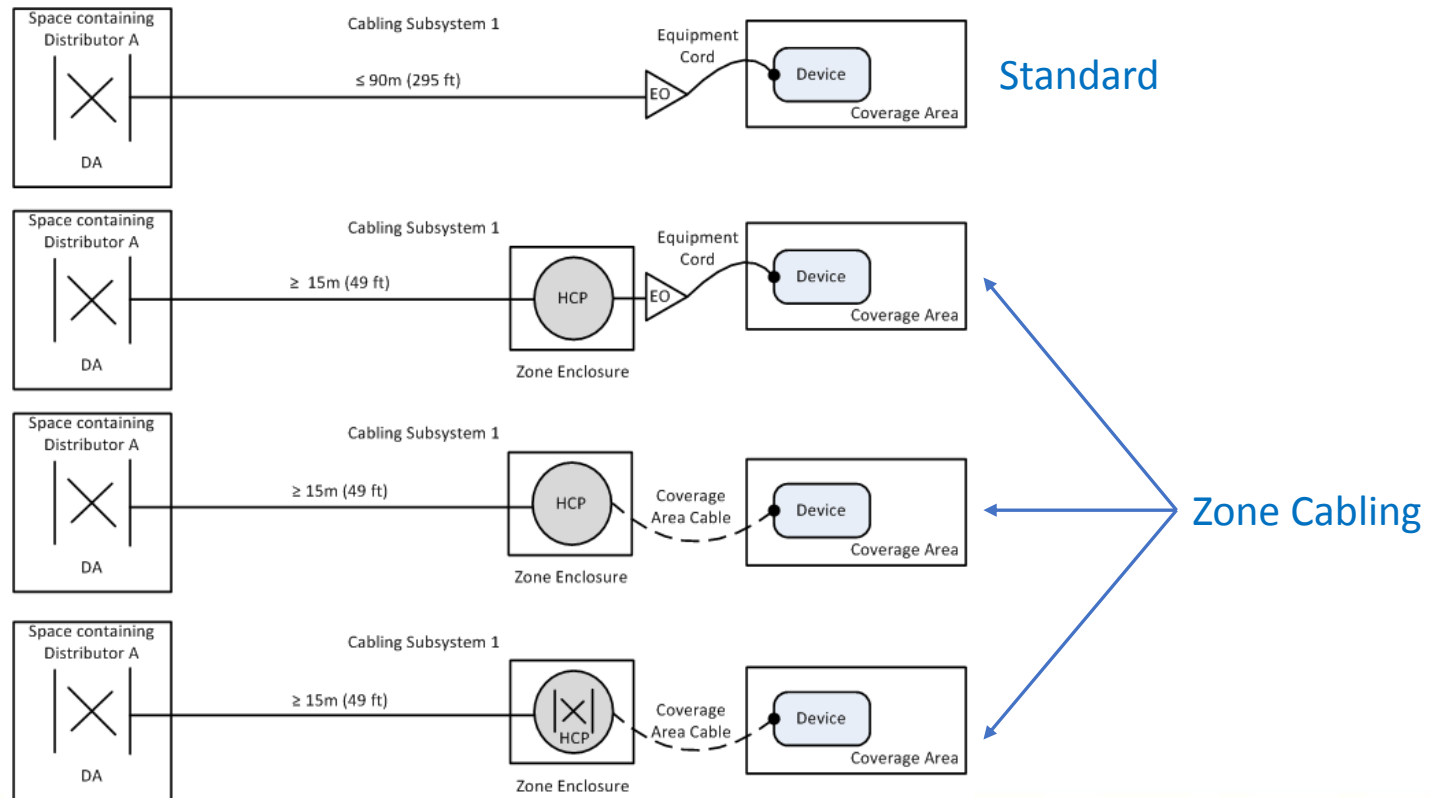

Terminology

Location/Device	TIA Standard	Terminology
Intermediate connection location in a zone cabling topology supporting a voice/data device	ANSI/TIA-568-0.D	Consolidation Point (CP)
Outlet connecting to a voice/data device	ANSI/TIA-568-0.D	Telecommunications Outlet (TO) ¹
Intermediate connection location in a zone cabling topology supporting a building device	ANSI/TIA-862-B	Horizontal Consolidation Point (HCP)
Outlet connecting to a building device	ANSI/TIA-862-B	Equipment Outlet (EO) ²

¹ A TO must always be present even if a CP is present

² An EO is optional if an HCP is present



ANSI/BICSI 007-2017

- *Technology Design and Implementation Practices for Intelligent Buildings and Premises*
- Communications Infrastructure & Network Integration
- Design Considerations (Power, Data, Zone Cabling)
- Building Systems (Lighting, Digital Signage, Vertical Transportation, Sound Systems, ESS, etc.)
- Building Monitoring Systems
- Commissioning

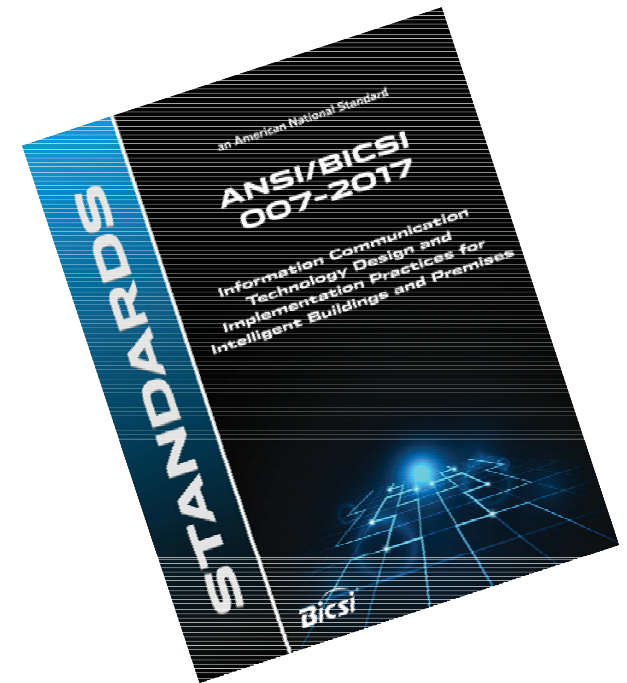

Agenda

- Remote Powering
- Impact on Cabling
- Intelligent Buildings
- Converged Cabling Designs



What is Zone Cabling?



Zone cabling supports convergence of data and voice networks, wireless (Wi-Fi) device uplink connections, and a wide range of sensors, control panels, and detectors for lighting, security, and other building communications



2018 BICSI Fall Conference & Exhibition



Bicsi

Zone Cabling Methodology

- ▶ Zone cabling is a standards-based approach to support convergence of devices
- ▶ Consists of cables run from connections in the telecommunications room (TR) to outlets housed in a zone enclosure servicing coverage areas
- ▶ Shorter cables run from outlets in the zone enclosure directly to devices or to outlets servicing devices

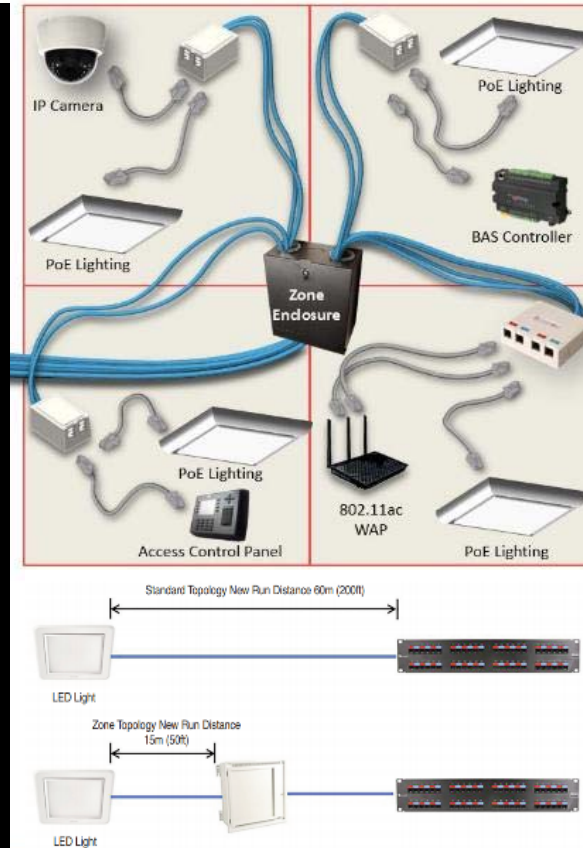

- ▶ 25% spare port availability recommended for best ROI
- ▶ Supports rapid reorganization and deployment of new devices and applications
- ▶ MAC work costs less, is faster and less disruptive
- ▶ Factory pre-terminated and tested trunking cables can be installed from the TR to the zone enclosure for quicker deployment



What is Zone Cabling?

(H)CP Housed in a
Zone Enclosure



Patch Panel in a TR



Device Outlet



2018 BICSI Fall Conference & Exhibition



Bicsi

Benefits of a Zone Cabling Design

- Supports rapid reorganization of work areas and equipment
- Simplifies deployment of new devices and applications
- Improved pathway utilization
- M-A-C work
 - Less costly
 - Faster to implement
 - Less disruptive
- Creates a flexible, “futureproof” infrastructure for voice, data, building devices, and wireless access points

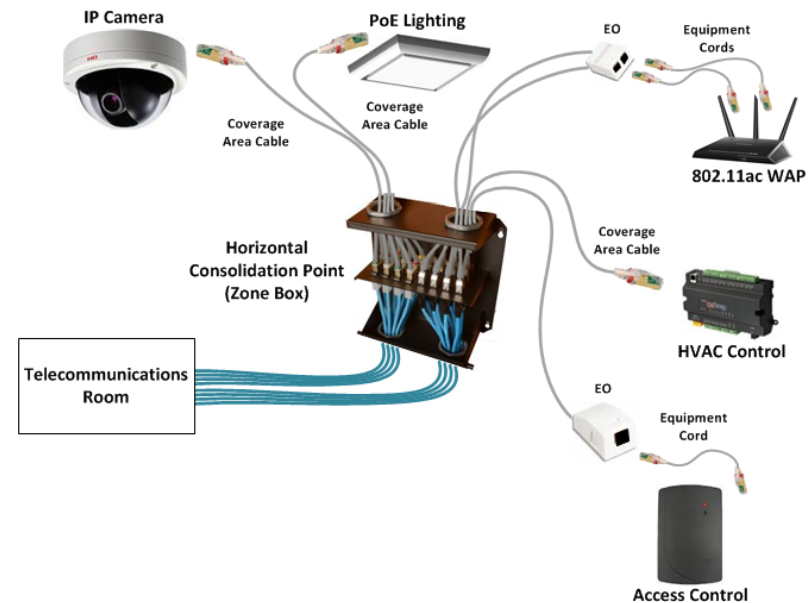

Zone Cabling Considerations

- A coverage area radius of 13m is generally recommended as an optimum size to accommodate most converged cabling networks
- Number of connections within the zone enclosure should not exceed 96
- Need to factor in future expansion

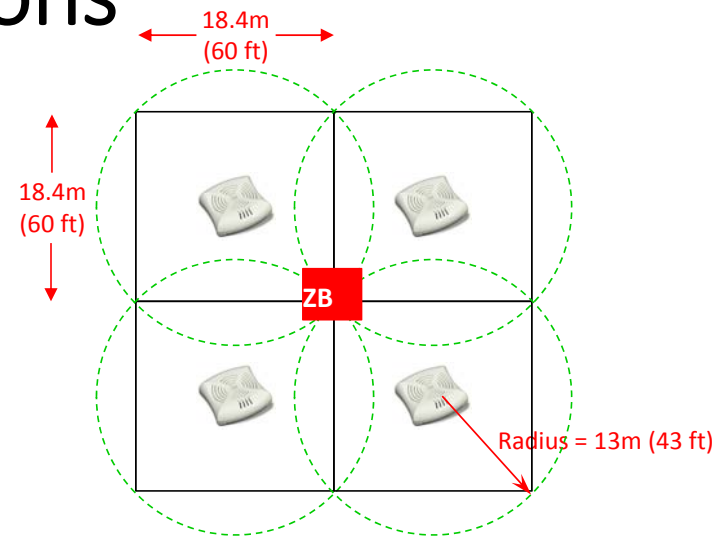

PoE Lighting: Unleashing Cost and Integration

- PoE now delivers enough power to operate commercial LED lighting
- Delivers significantly lower capital and labor investment
- LED lights consume half the energy of fluorescents and last 5X longer
- Earth and tenant friendly with less emissions and no hazardous mercury
- Integrates with other IoT applications and can receive centralized IT back up power

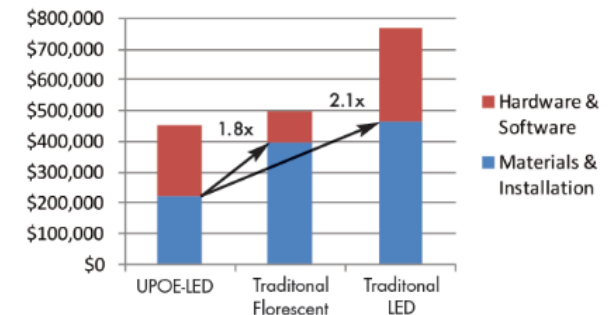

Upfront Cost Comparison for a 35,000ft² building in New York City



PoE Lighting: Unleashing Cost and Integration

- Centralized control
- Occupancy sensors
- CO₂ sensors
- Humidity sensors
- Daylight harvesting
- Energy consumption
- *LiFi network connectivity*
- Intelligence to adapt to patterns and preferences
- Color coding and flashing patterns for security and/or threat level notification



Centralized – Fixture Centric

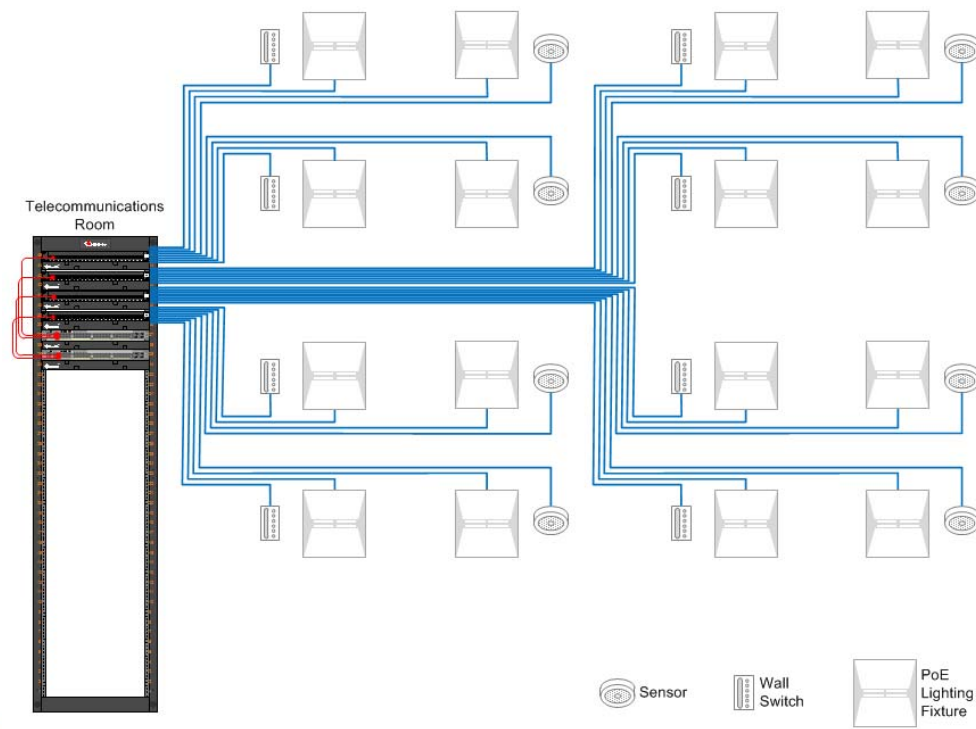

Centralized – Node Centric

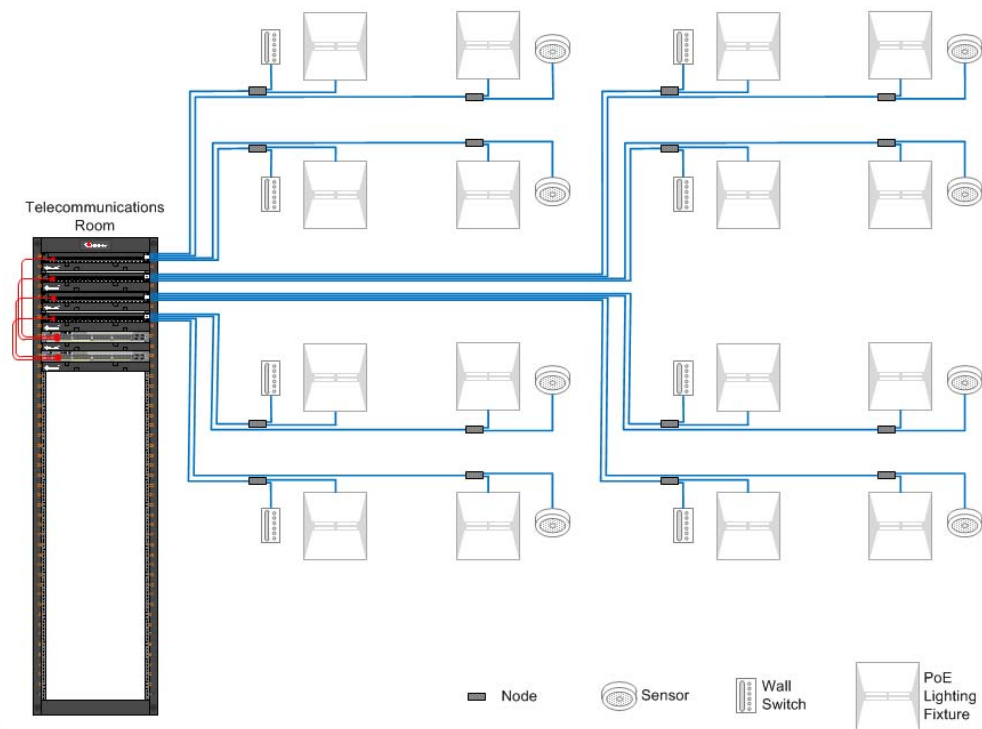

Centralized Zone - Fixture Centric

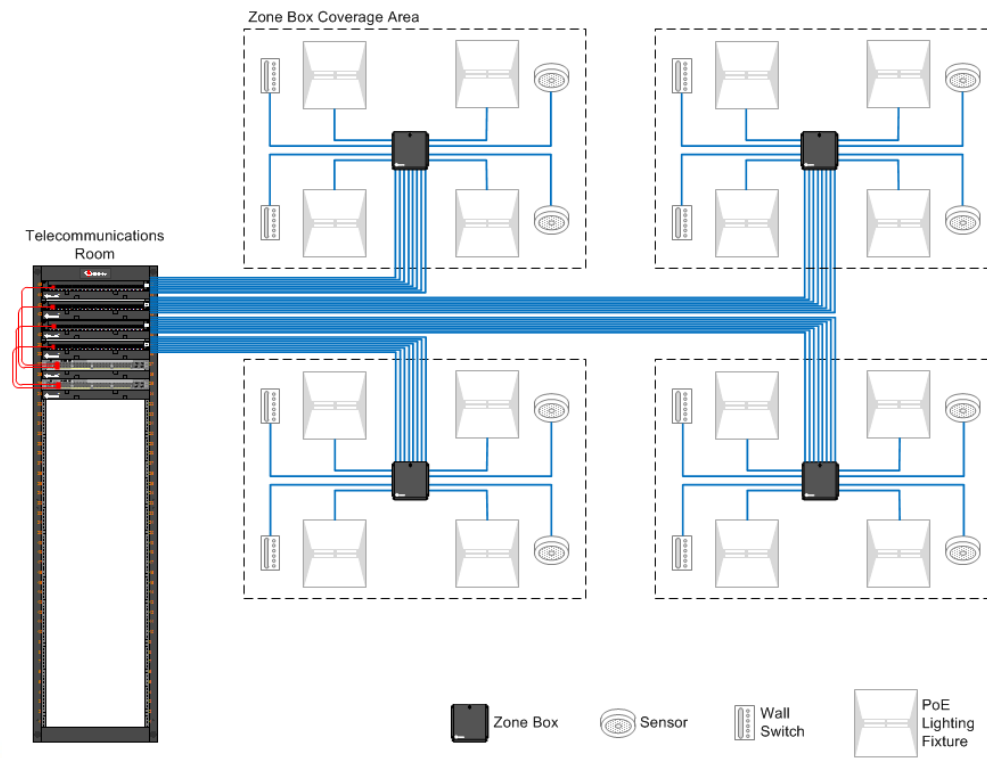

Centralized Zone – Node Centric

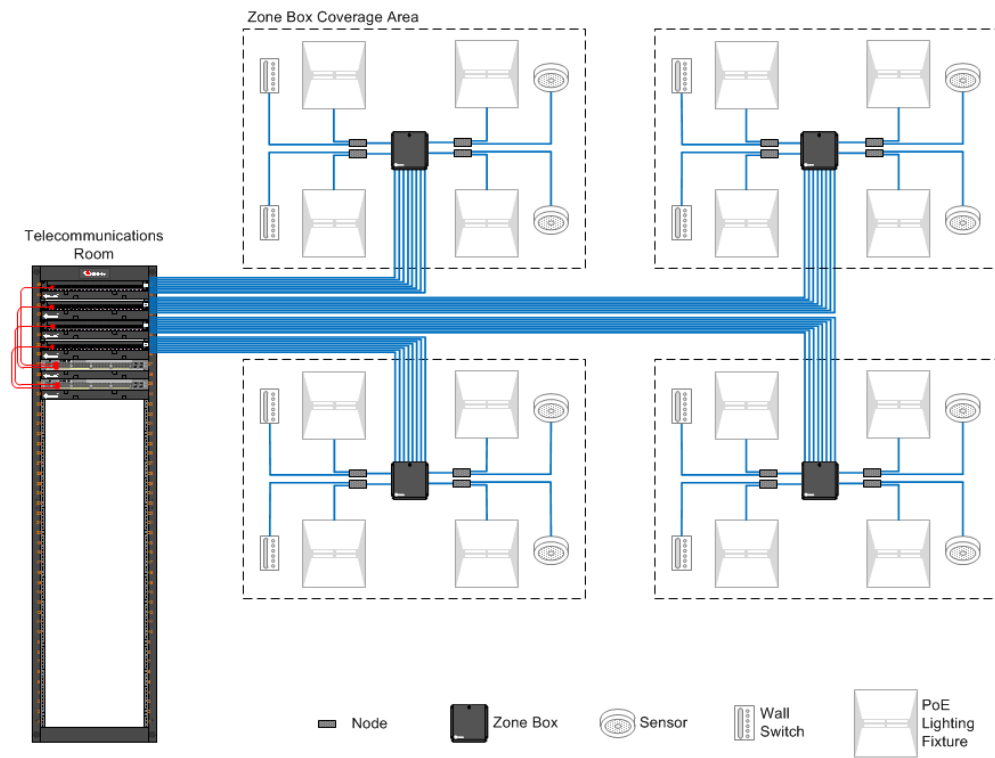

De-centralized – Fixture Centric

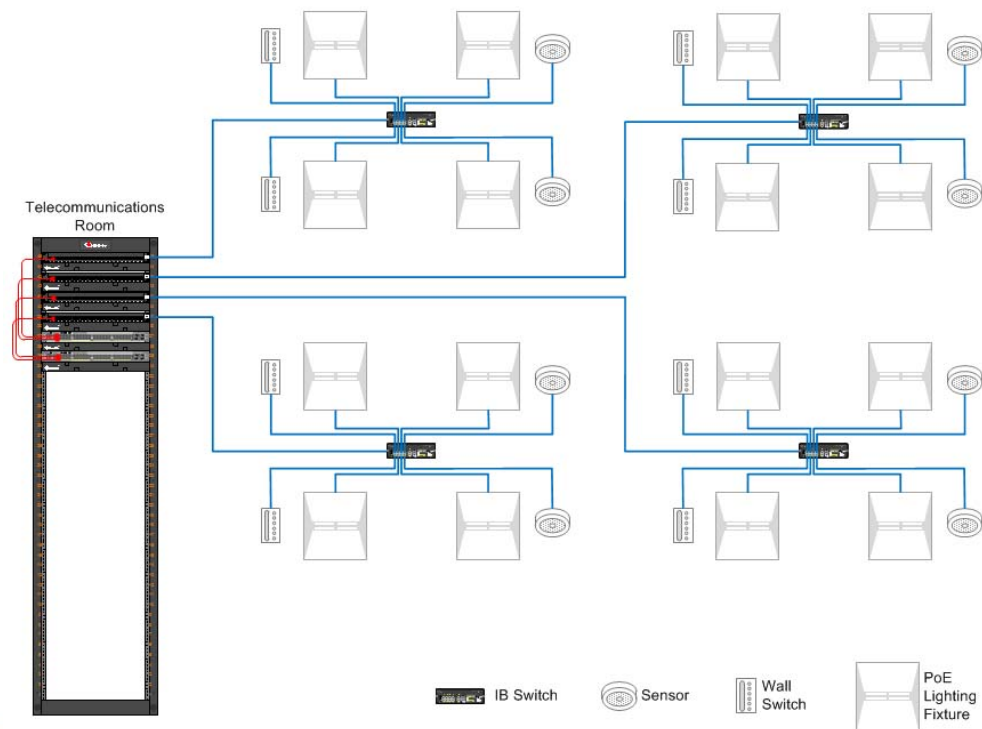

De-centralized – Node Centric

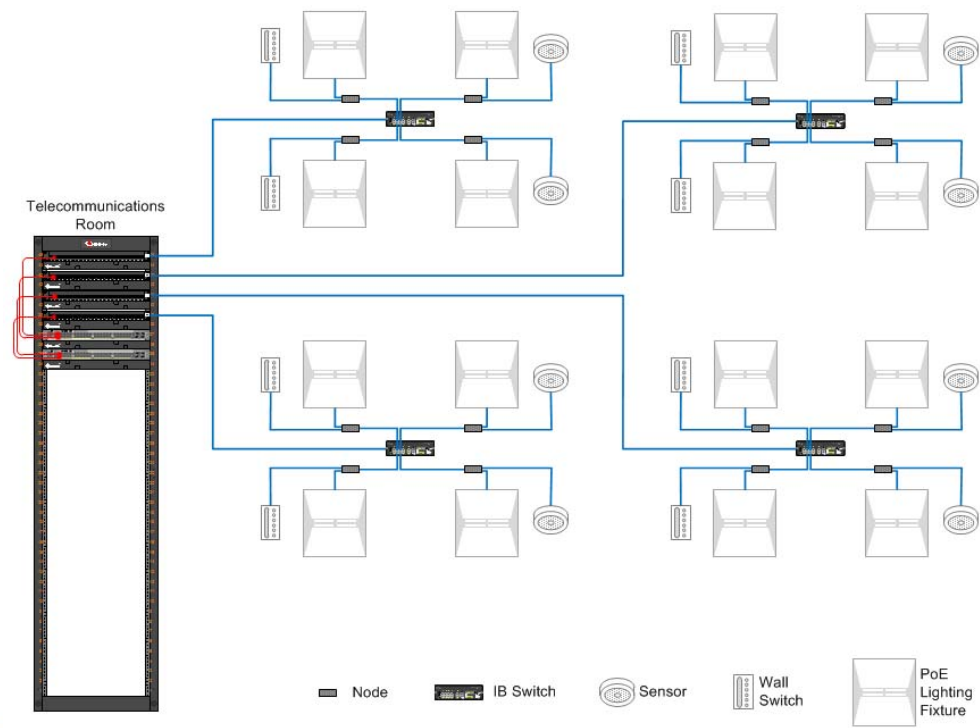

De-centralized Zone – Fixture Centric

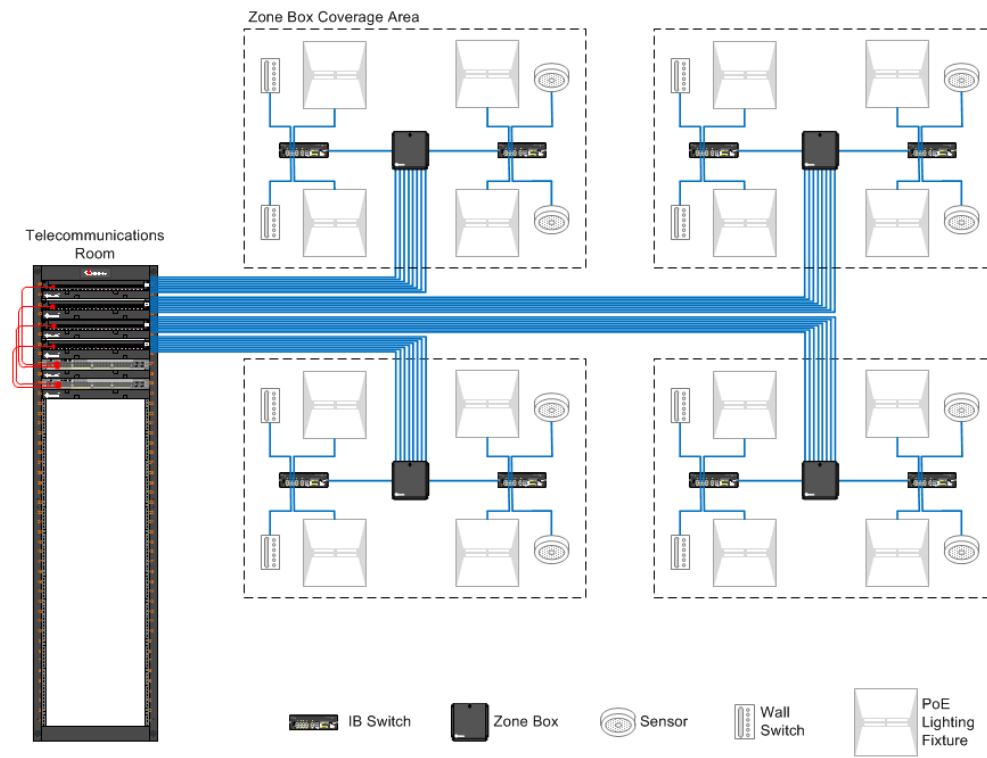

De-centralized Zone – Node Centric

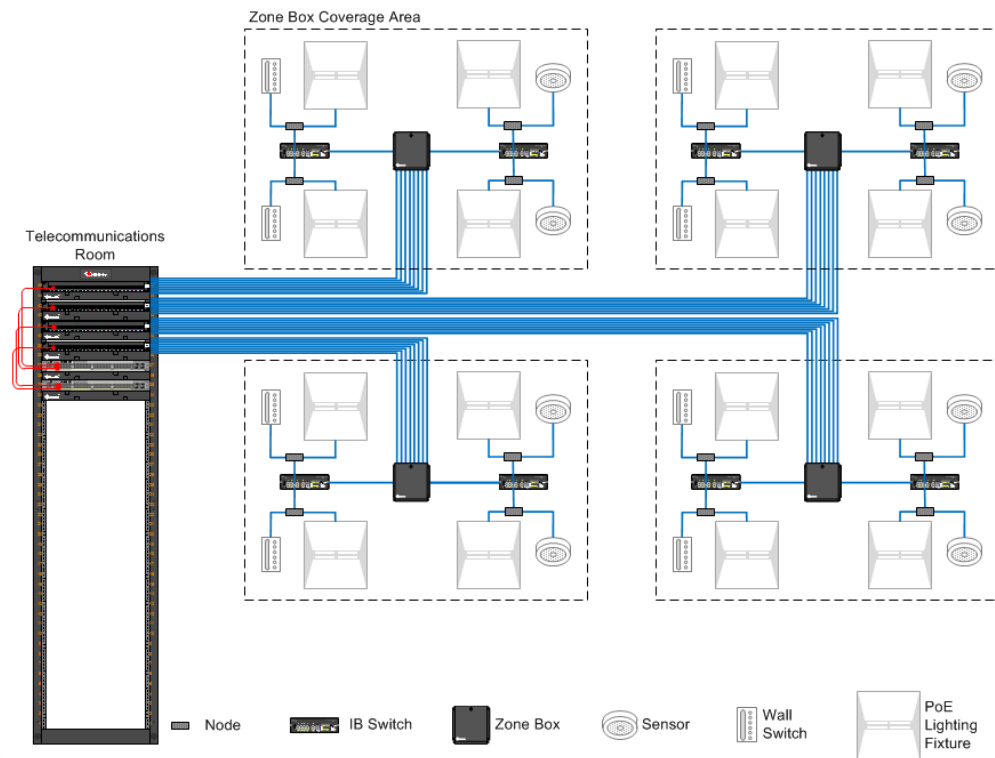

Quiz Question #5

What is an MPTL?

A: Modular Plug Terminated Link



2018 BICSI Fall Conference & Exhibition



Bicsi

Modular Plug Terminated Link



2018 BICSI Fall Conference & Exhibition



Modular Plug Terminated Link (MPTL)

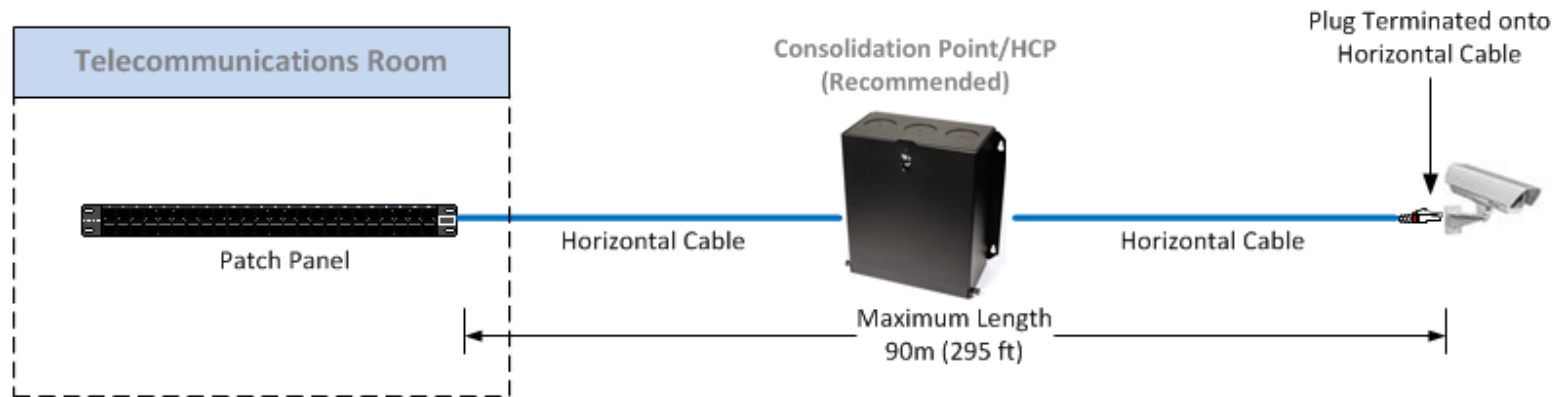

- The MPTL is constructed by direct field termination of horizontal cabling at the device end with a modular plug - replacing the TO/SO and associated Work Area (WA) cord.
- ANSI/TIA-568.2-D requires that horizontal cable be terminated onto a TO. In certain cases there may be a need to terminate horizontal cables directly to a plug.
- ANSI/BICSI-007 recognizes the MPTL and refers to it as a direct connection method, with or without an HCP.
- ANSI/TIA-862-B-2016 recognizes direct connections – should be limited to devices in fixed locations that are not expected to be replaced or required to be directly connected by the AHJ



What are the market drivers?

- IoT and Intelligent Buildings are driving the proliferation of IP-based and PoE-based devices in the walls and ceilings of modern buildings
- LED lights, security cameras, wireless access points, digital displays, distributed antenna systems (DAS), building automation control devices and more can be directly connected using plug-terminated links rather than via boxes, outlets and patch cords



What are the benefits of an MPTL?

- Custom length, quick connections in the field for direction connection to devices
 - Ideal for a zone cabling design methodology
 - Can be plugged into the zone enclosure on one end and terminated to outlets on the other end for computers, phones, etc.
 - Simplifies project bill of materials and eliminates the need for predetermined patch cord lengths
- Improves performance and allows for more efficient power delivery by eliminating patch cords and outlets
- Improves security for devices like surveillance cameras by eliminating exposed patch cords

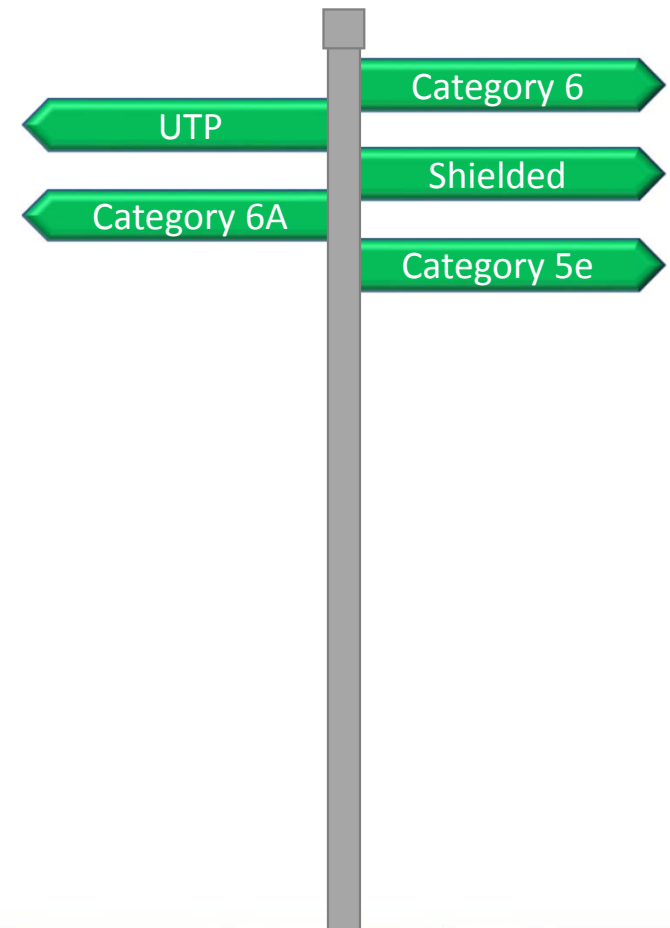

Photo taken at McCarran Airport in Las Vegas – Anyone could jump up and pull out the patch cord to the surveillance camera and wireless access point.



Media Selection

- TIA TSB-184-A-2017
 - Category 6A recommended
- TIA-862-B-2017
 - Category 6; category 6A recommended
- ISO/IEC 11801-6 Ed1.0
 - Class E_A or higher
- BICSI 007-2017
 - Category 6A/Class E_A or higher recommended



Benefits of Shielded Cabling

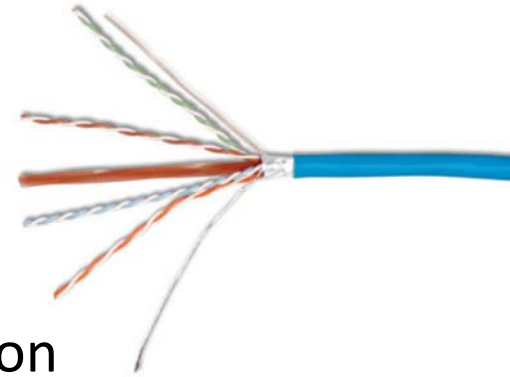

- Typically qualified for higher temperature (75°C) operation
- Reduced length de-rating
- Superior heat dissipation supporting larger bundle sizes



The Shielded Evolution

- Shielded outlet technology has improved significantly
- Termination practices simplified
- Outlets can be color coded



Quiz Question #6

What type of rating must a product have to be installed within a plenum environment?

A: A plenum rating!



2018 BICSI Fall Conference & Exhibition



Bicsi

Plenum Products

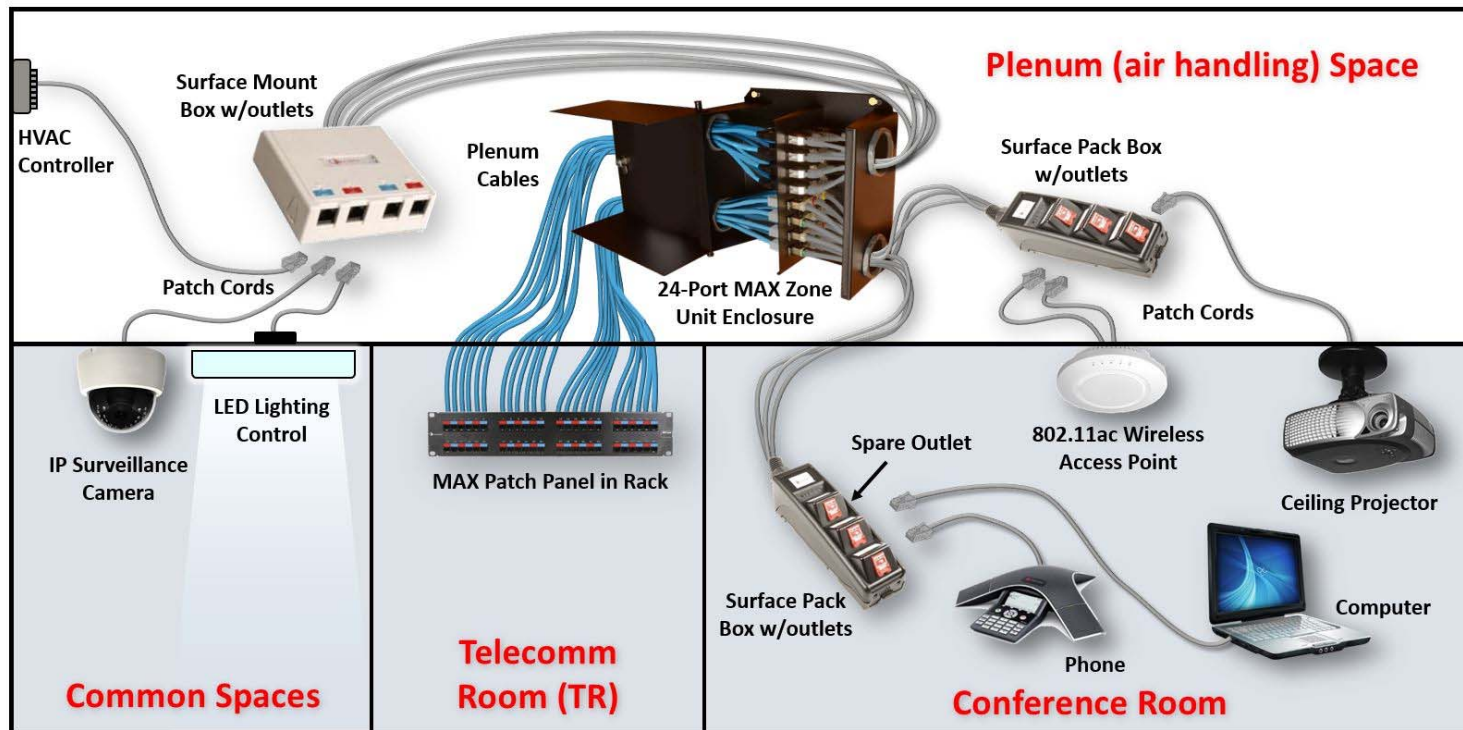

Summary



- Increasing numbers of IB applications will run over a low voltage RJ-45 platform
- Remote powering places increased demands on network cabling systems
- Zone cabling provides a flexible infrastructure
- Modular plug terminations have a role



Thank You



Dave Valentukonis, RCDD/NTS

Siemon NA Technical Services Group Manager

dave_valentukonis@siemon.com

860.945.4364



2018 BICSI Fall Conference & Exhibition



Bicsi

Testing for Four Pair PoE

Mark Mullins

mark.mullins@flukenetworks.com



2018 BICSI Fall Conference & Exhibition



Bicsi

**Modular Plug
Terminated Link**

**Ethernet Alliance
Certification**

**Resistance Testing
for PoE**



2018 BICSI Fall Conference & Exhibition



Bicsi

A Simplified Installation Technique

- ✓ AP's, Cameras, Locks, Sensors, etc.
- ✓ Lower Cost
- ✓ Cleaner Look
- ✓ More Secure



Field Terminated Plug Examples

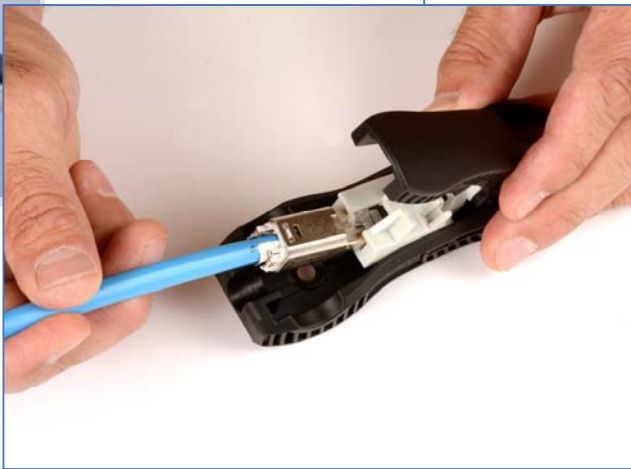
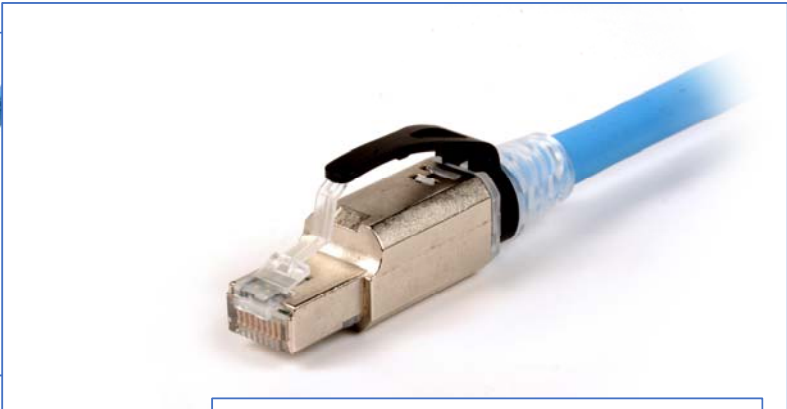

Modular Plug Terminated Link (MPTL)

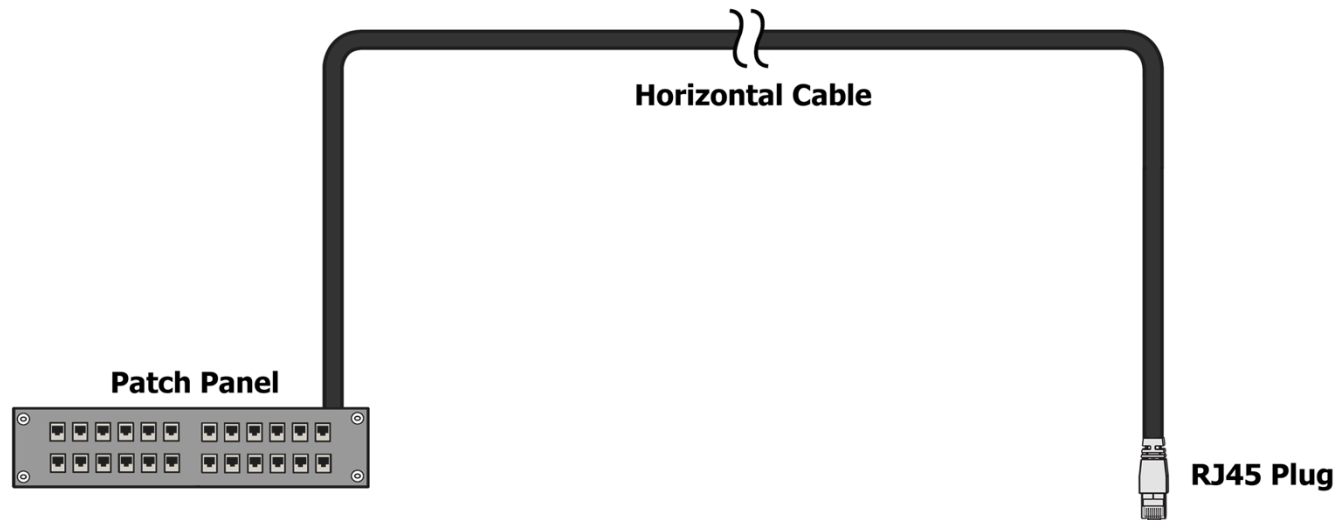

So, How Do I Test This Thing?



2018 BICSI Fall Conference & Exhibition



Bicsi

Is This a Permanent Link?

- ✓ Starts at a Patch Panel
- ✗ Includes Outlet
- ✗ No Final Plug

Two connector permanent link definition:

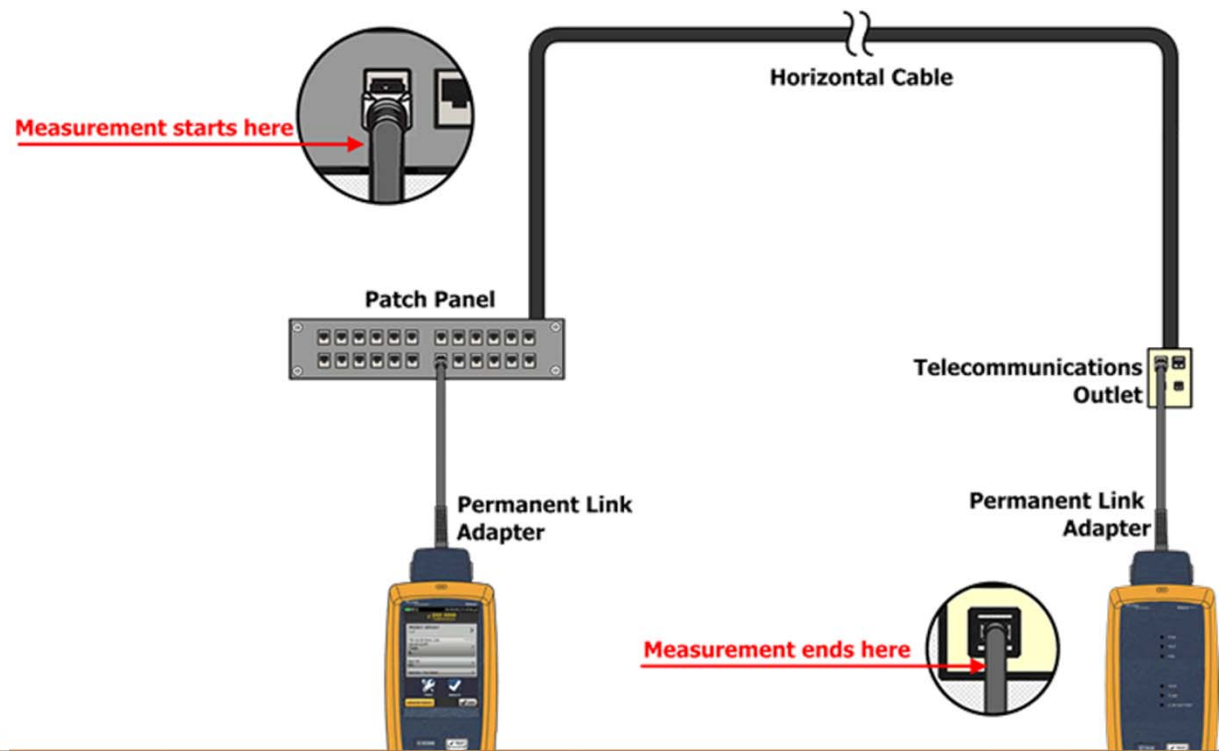

Is This a Channel?

Two connector channel definition:

- ✓ Includes Patch Cord
- ✗ Starts with Patch Cord
- ✗ Doesn't Include Last Plug

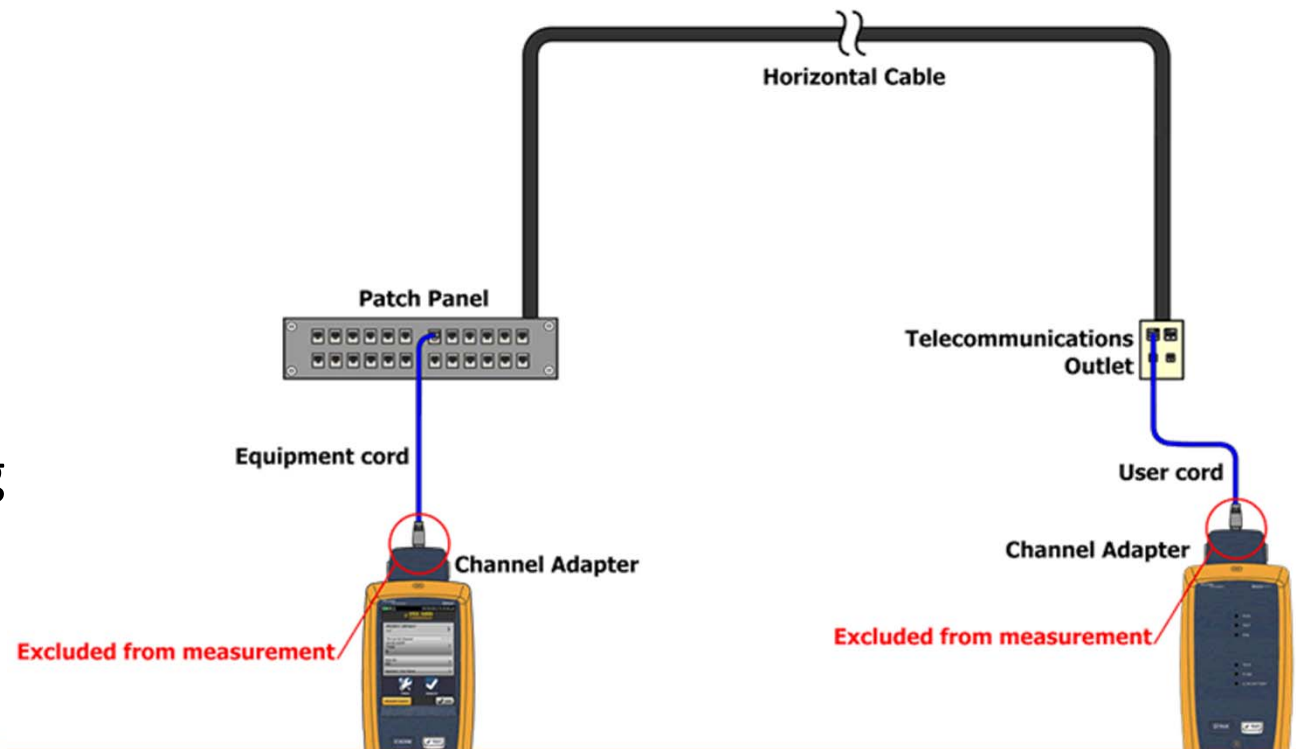

MPTL Definition

- Formerly Defined by BICSI as “Direct Attach”
- Defined in ANSI/TIA 568.D-2 (Approved June 2018) Annex F
- ISO to Discuss in Fall 2018
- Max. 295 ft. (90 m)
- Category 5e, 6, 6A

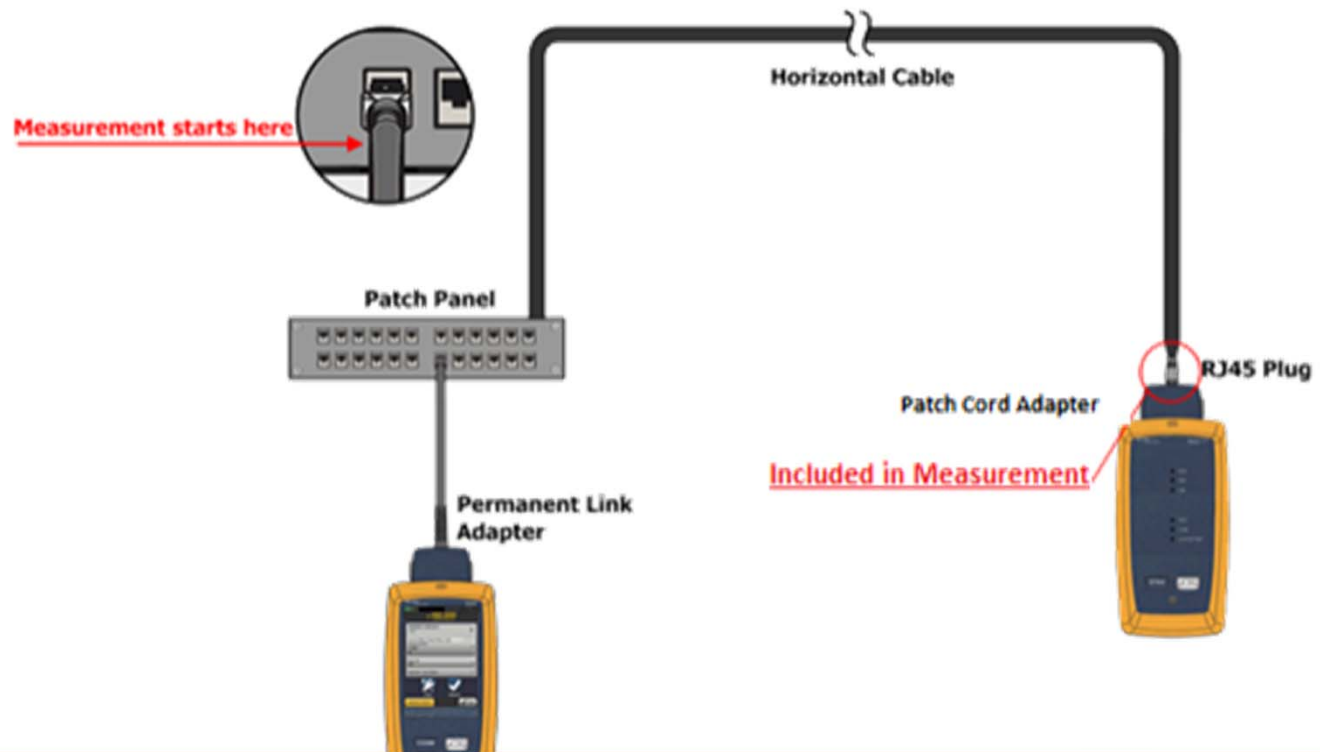

MPTL Definition

This is like a Permanent Link

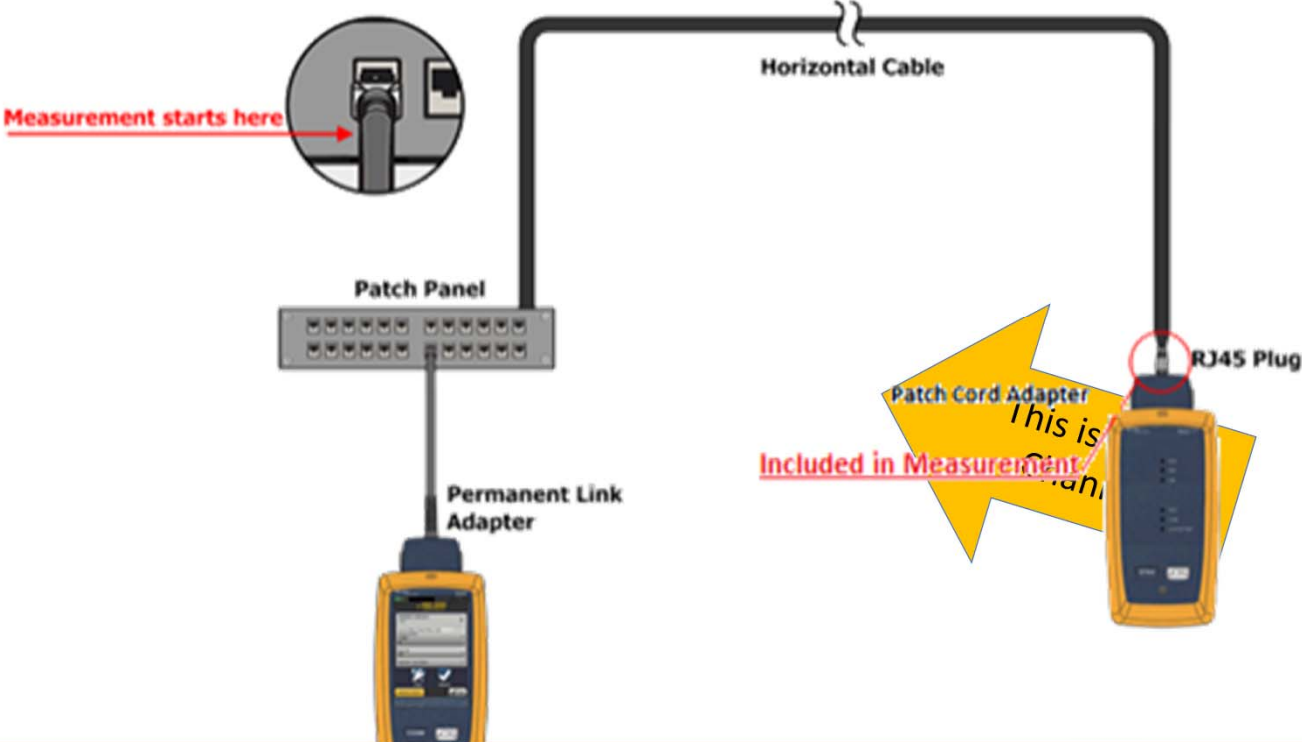

Testing the MPTL: What You Need

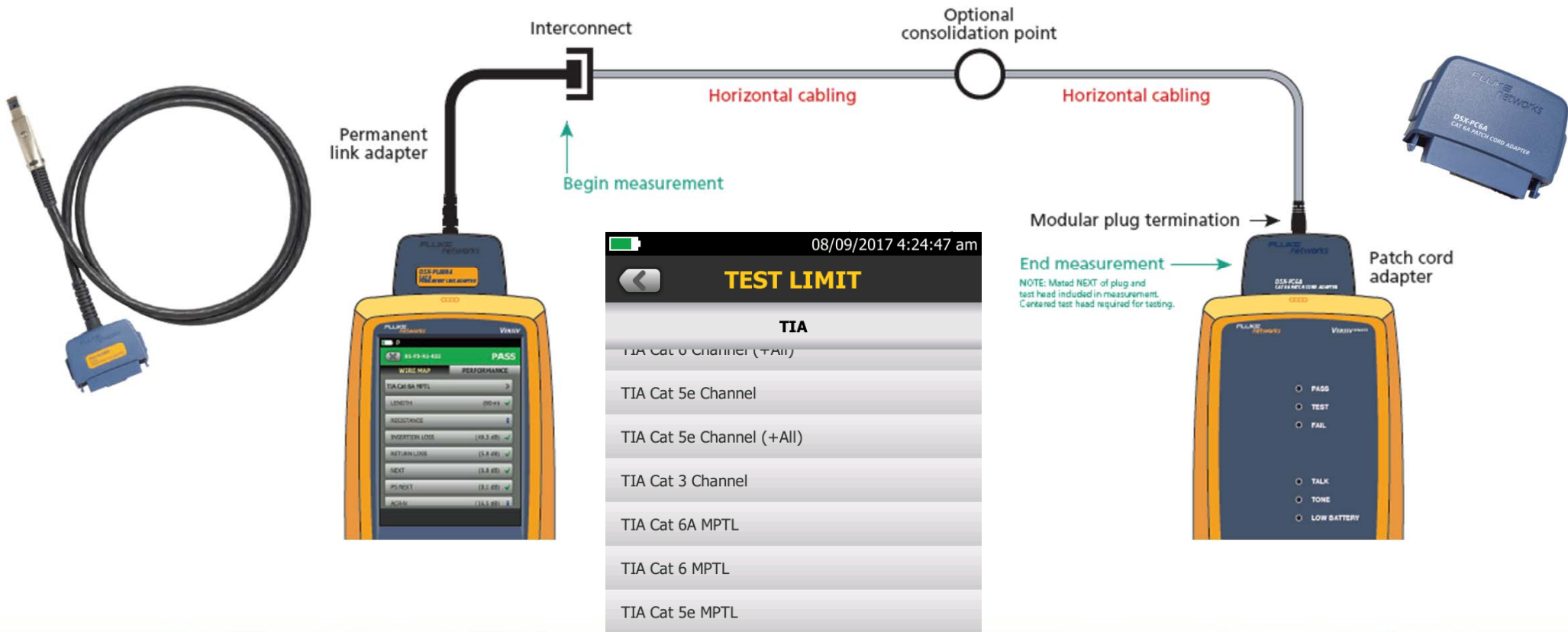

**Modular Plug
Terminated Link**

**Ethernet Alliance
Certification**

**Resistance Testing
for PoE**



2018 BICSI Fall Conference & Exhibition



Bicsi

Quiz Questions

- What's the power available at the PD for Class 3?
 - 13W
- Based on 802.3bt, what class of power is available from a PoE++ device?
 - Class 5 or 6
- How many pairs are used in Class 4 implementations?
 - Two or Four



Power Over Ethernet

- IEEE 802.3bt – 4 pair Power over Ethernet
 - Now technically complete and no new features to be added
 - Type 1 and Type 2 PSE devices are as per 802.3af and at standards
 - Type 3 and Type 4 PSE devices added, 60W and 90W respectively
 - Updated end types to support 2.5G, 5G and 10G Ethernet
 - New midspan PSE to support the higher speeds
 - Warning added not to use smaller than 26AWG cabling with PoE
 - Out for sponsor ballot, expected to publish Q3 2018.



PoE Confusion

- Not a Licensed Term
- Three Standards: 802.3af, 802.3at, 802.3bt
- Eight Classes / Wattage Levels
- Four Types: 1 and 2 (two pair), 3 and 4 (four pair)
- Common Names: PoE, PoE+, PoE++, UPOE
- Passive, LLDP, and Negotiated Implementations
- Interoperability?



Understanding Classes and Types

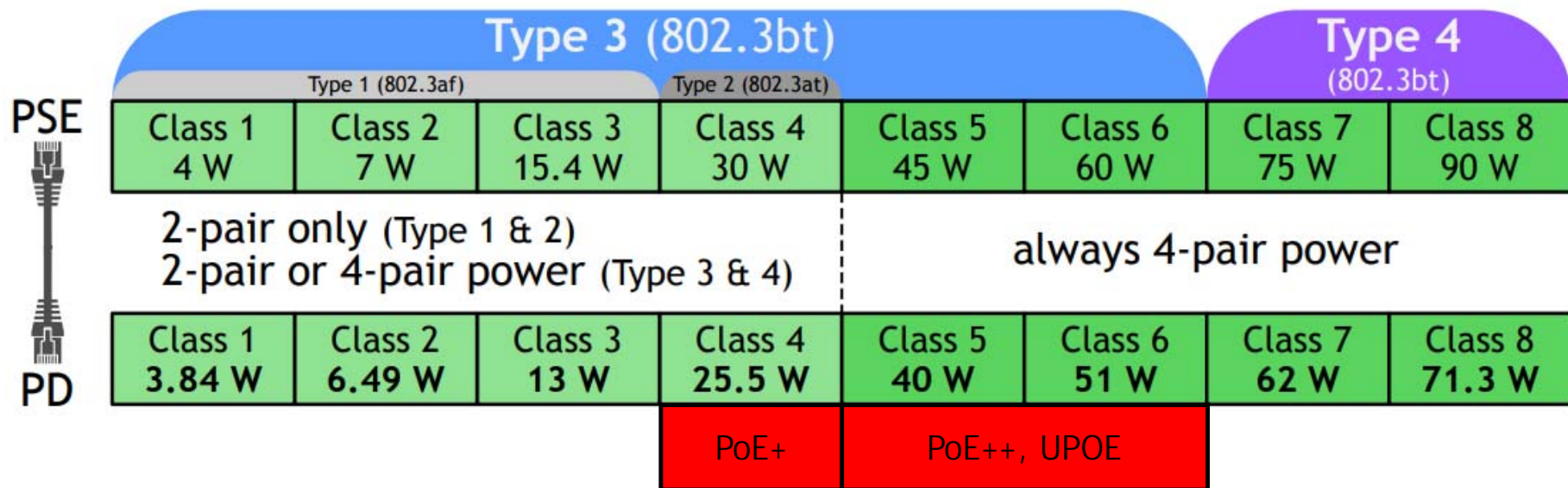

Ethernet Alliance PoE Certification

(Number Indicates Class of Device)



Power Sourcing Equipment



Powered Device



2018 BICSI Fall Conference & Exhibition



This Won't Work



**Modular Plug
Terminated Link**

**Ethernet Alliance
Certification**

**Resistance Testing
for PoE**



2018 BICSI Fall Conference & Exhibition



Bicsi

Four Pair PoE in Operation

- The powered device completes the current loop, enabling the device to work
- The current is “balanced” across all 4 wires used.
- Requires low and balanced cable resistance

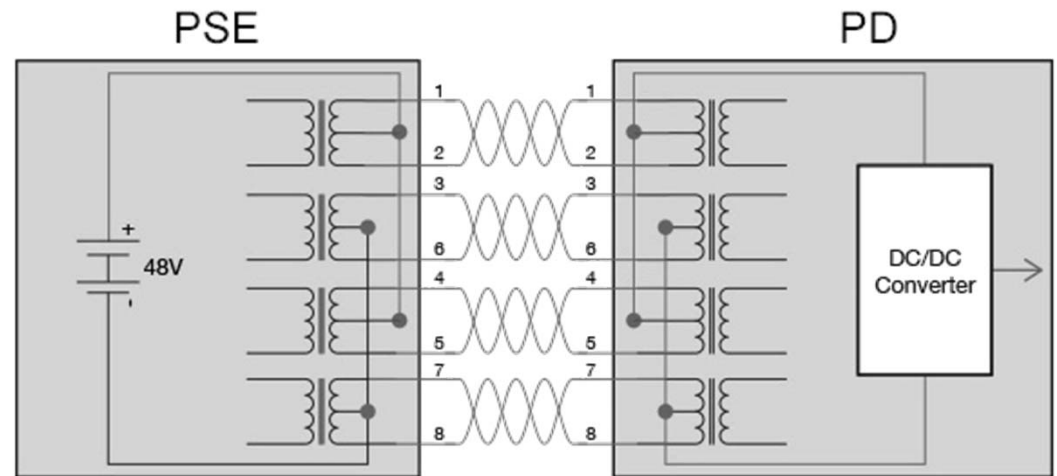

Cabling Requirements

- Your standard Cat 5e, 6, or 6A field test is probably not good enough
- Within ANSI/TIA-568.2-D and IEEE 802.3, you will find:
 - dc loop resistance
 - dc resistance unbalance within a pair
- The measurements are “optional” in TIA-1152-A



2018 BICSI Fall Conference & Exhibition



Bicsi

1. Loop Resistance



All Four Pairs < 25 Ω



2. P2P Resistance Unbalance

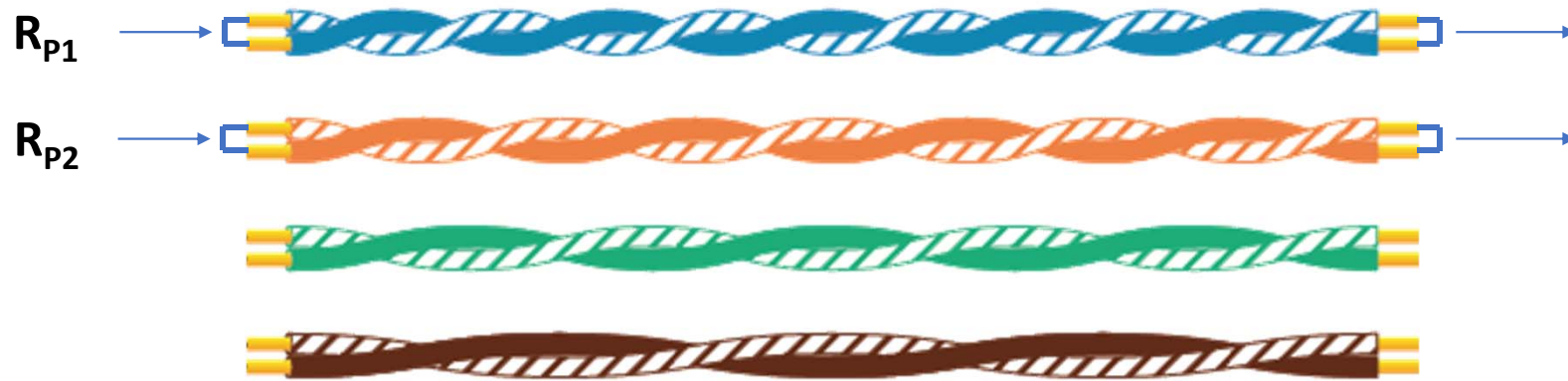

$$\text{Resistance Unbalance}_{\text{between pairs}} = \left[\frac{|R_{p1} - R_{p2}|}{R_{p1} + R_{p2}} \right] 100\%$$

All Six Measurements < 0.2 Ω or 7.5%



3. Pair Resistance Unbalance



$$\text{Resistance Unbalance}_{\text{within a pair}} = \left[\frac{|R_{C1} - R_{C2}|}{R_{C1} + R_{C2}} \right] 100\%$$

All Four Measurements < 0.2 Ω or 3.0%



Problems Resulting From Resistance Issues

- Overheating
- Power Loss
- Data Loss



2018 BICSI Fall Conference & Exhibition



Bicsi

Causes of Resistance Issues

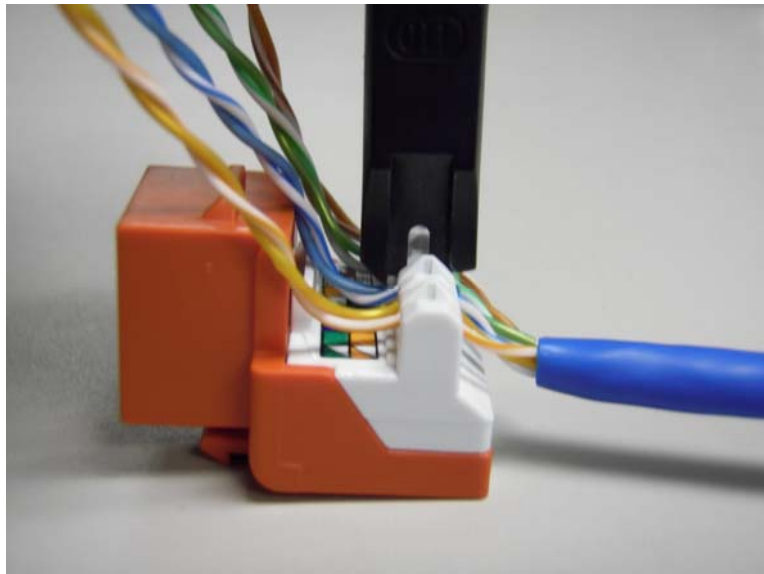

Workmanship

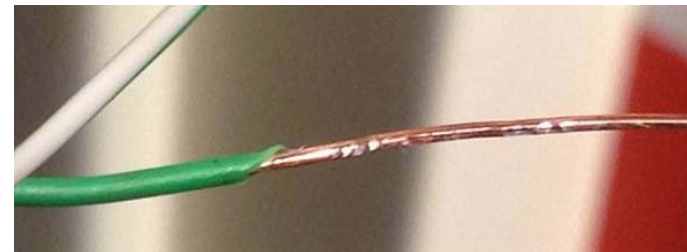

Cable Quality



Resistance Testing

009		PASS
LOOP	PAIR UBL	P2P UBL
	✓	
	VALUE (Ω)	
1,2	1.87	
3,6	1.84	
4,5	1.92	
7,8	1.84	
LIMIT	21.0	

Loop Resistance

009		PASS
LOOP	PAIR UBL	P2P UBL
	✓	
	VALUE (Ω)	LIMIT (Ω)
1,2	0.001	0.20
3,6	0.002	0.20
4,5	0.007	0.20
7,8	0.013	0.20

Pair Unbalance

009		PASS
LOOP	PAIR UBL	P2P UBL
	✓	
	VALUE (Ω)	LIMIT (Ω)
1,2-3,6	0.017	0.20
1,2-4,5	0.004	0.20
1,2-7,8	0.016	0.20
3,6-4,5	0.013	0.20
3,6-7,8	0.001	0.20
4,5-7,8	0.012	0.20

Pair-to-Pair Unbalance



Questions



2018 BICSI Fall Conference & Exhibition



Bicsi

Thanks for Your Attention

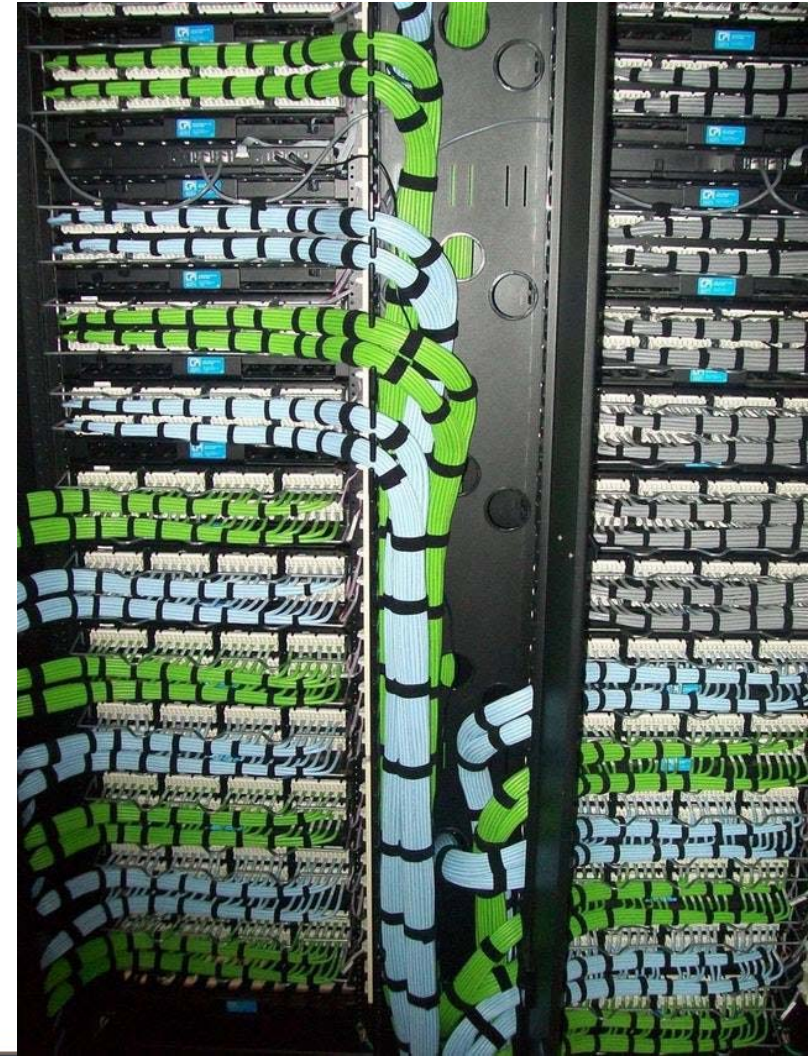

2018 BICSI Fall Conference & Exhibition



Bicsi

End Products and Security

Geoffrey Bauer, ESS, PSP
Manager, A&E Program
Axis Communications



2018 BICSI Fall Conference & Exhibition



Bicsi

Internet of Things (IoT)

- 50 Billion Internet Of Things Connections Projected By 2022
(www.mediapost.com)

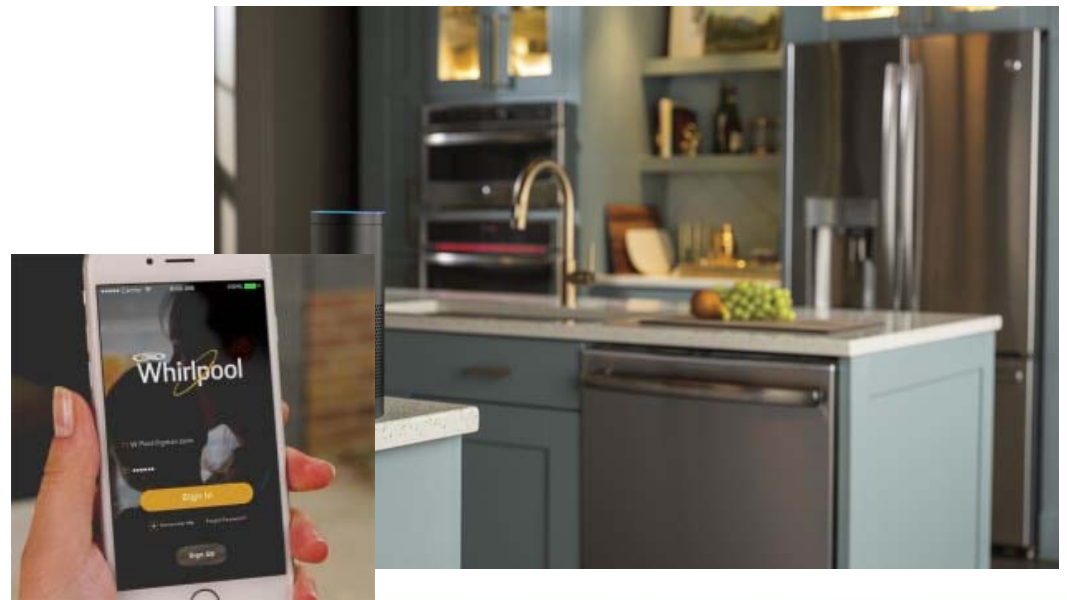

Internet of Things (IoT) - Security

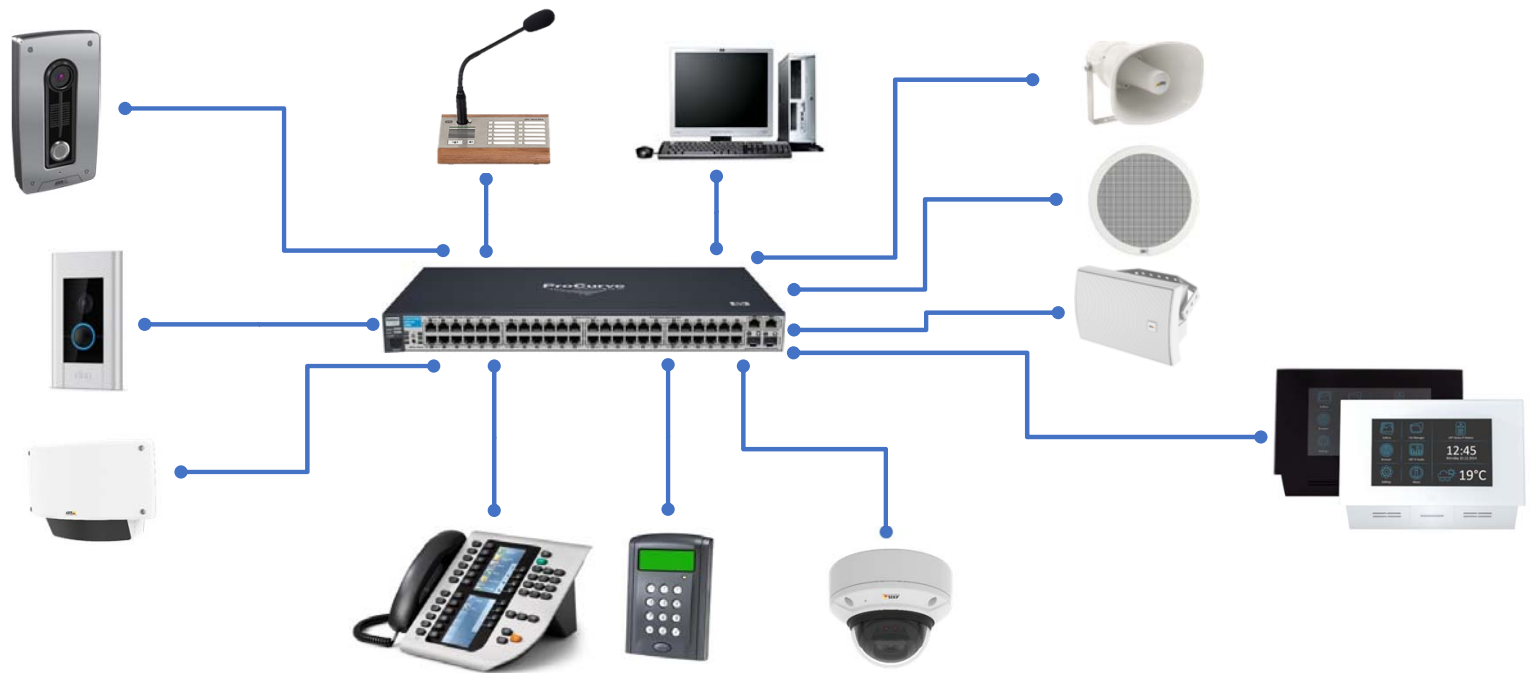

2018 BICSI Fall Conference & Exhibition



Bicsi

We Need More Power

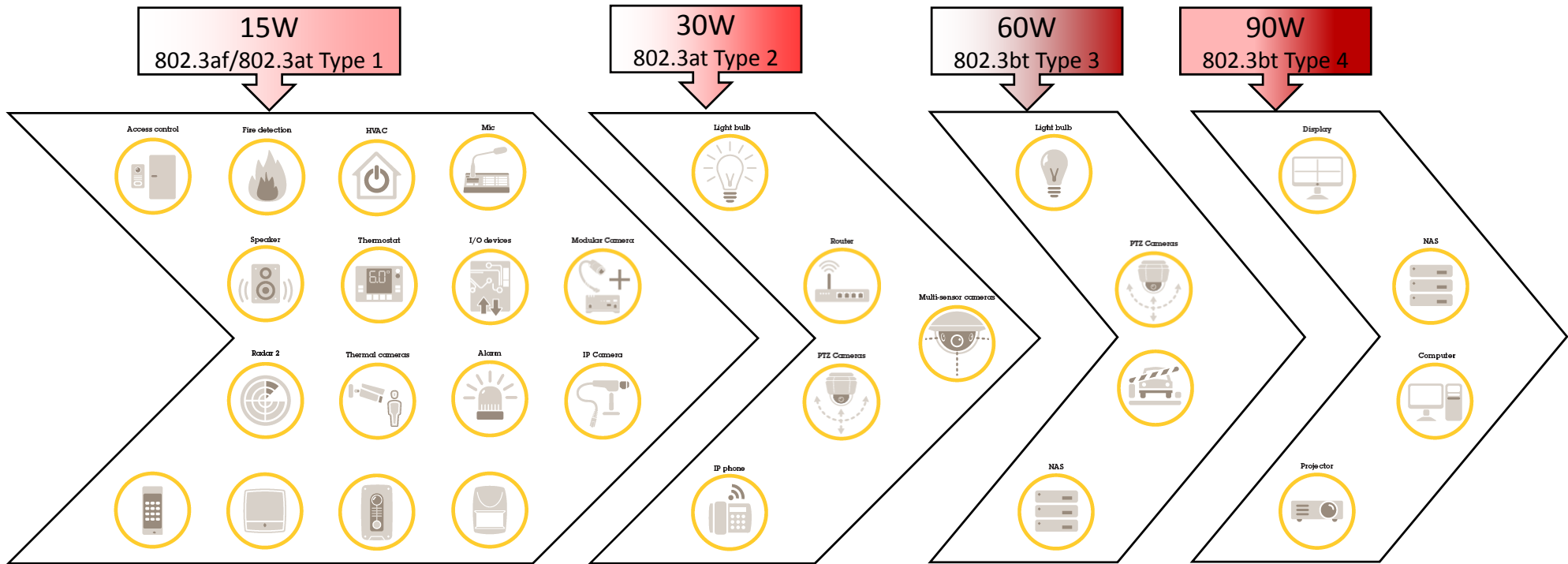

PoE Midspan Devices

- PoE “injector” options

- 15W (IEEE 802.3af)
- 30W (IEEE 802.3at) PoE+
- 60W (IEEE 802.3bt) PoE++
- 90W (IEEE 802.3bt)



- Midspans are either unmanaged or managed out of band

- PoE is managed as part of the data path and the statistics show up as part of the line communication and on the switch
 - Midspan power information has to come from the midspan or through a separate tool



Physical Security

“Detect”



2018 BICSI Fall Conference & Exhibition



Bicsi

PoE Intrusion Monitoring

- Motion Detectors

- Powered by the device (camera) via the I/O port
- Z-Wave Connectivity (wireless to PoE device)
- Hidden sensors for video (covert)

- Laser scan detector

- Detects object's size, speed, and distance

- LIDAR & RADAR

- Delivers exact position of a moving object
- Minimizes false alarms from spiders, small animals
- Reliable detection even in bad weather (rain, fog, snow)



Monitoring and Control

“Detect” and “Deter”



2018 BICSI Fall Conference & Exhibition



Bicsi

Network Input / Output Control

- Powered using PoE/PoE+ (or external power)
 - Analog alarm inputs
 - Supervised / Non-supervised inputs
 - Door contact, Window sensor, Motion detector, all things analog
 - Relays
 - TTL and Form C relays
 - Typical 12VDC / 24VDC / Dry contact relays
 - Trigger analog audio devices
 - Trigger analog lighting displays
 - Trigger ADA release sequence for entry doors
 - Elevator Control
 - Control what floors are accessed
 - Provide details of persons movement



IP Surveillance

IP Cameras for the “eyes”



2018 BICSI Fall Conference & Exhibition



Bicsi

Types of Cameras

- > Covert
- > Fixed Box
- > Fixed Dome
 - Panamorph
 - Multi-Sensor
 - PTRZ
- > Bullet
- > Thermal
- > Positioning
 - Dome
 - Bi-spectral
 - Professional AV
- > Explosion proof



PoE Requirements for Surveillance

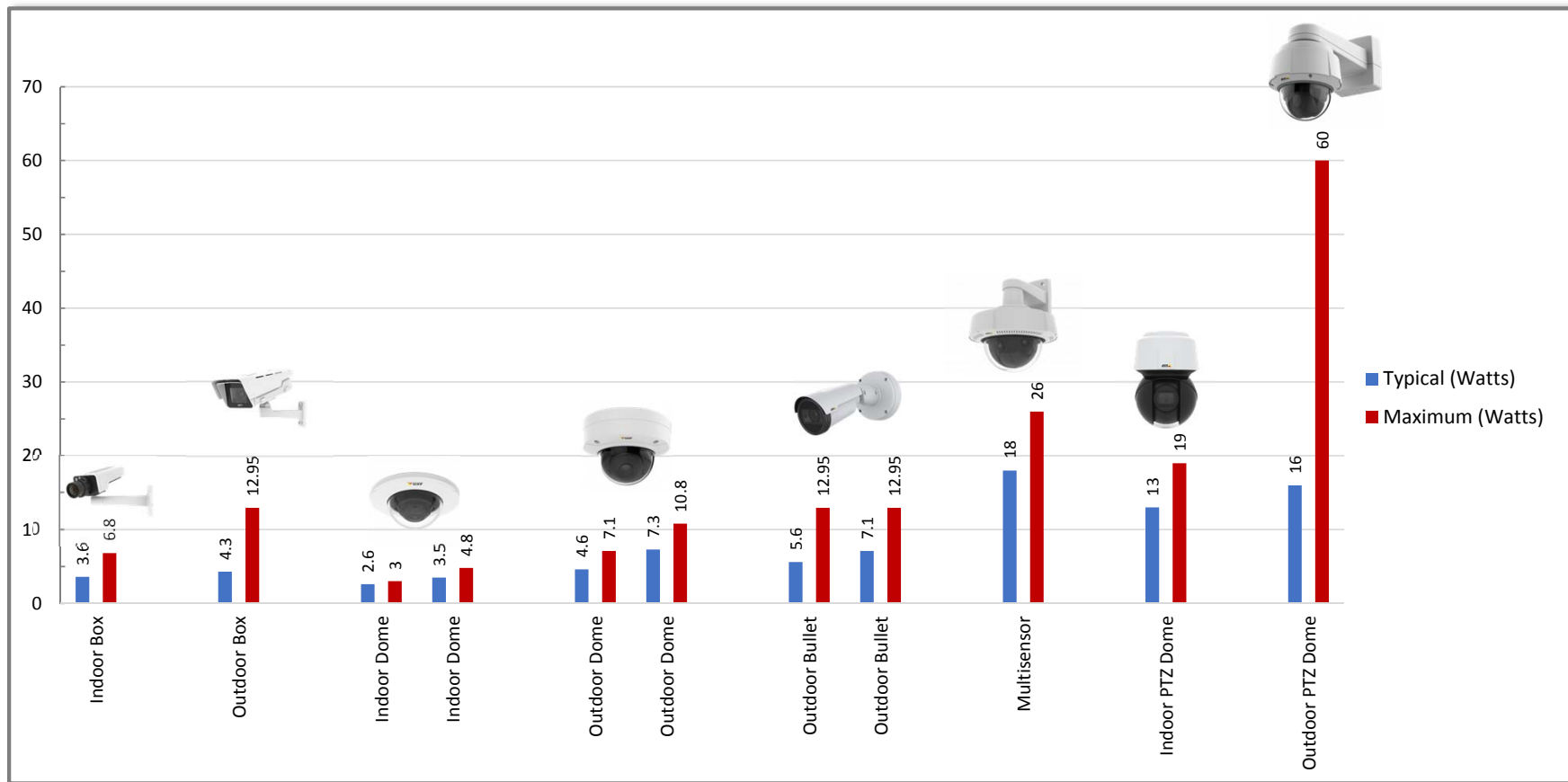

PoE Requirements for Surveillance

- Positioning Camera

- SFP or RJ45 10BASE-T/100BASE-TX/1000BASE-T network connector
- 24VAC/VDC Max **200-300 W**, typical **16-64 W** (IR)
 - Temperature: Normal: -50 °C to 55 °C (-58 °F to 131 °F)
 - Arctic Temperature Control: start-up at -40 °C (-40 °F)
 - Operational wind load of 106mph
 - Precision motors with presets
 - Bi-spectral



How does more power influence project designs?

Using surveillance as an example ...



2018 BICSI Fall Conference & Exhibition



Bicsi

Resolution

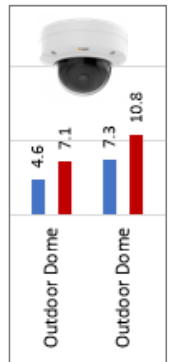

2018 BICSI Fall Conference & Exhibition



Bicsi

Wide Dynamic Range



WDR - On



WDR - Off

Image Stabilization



2018 BICSI Fall Conference & Exhibition



Bicsi

Low-light



- Indoor storeroom at approximately 0.4 lux.



IR Illumination



2018 BICSI Fall Conference & Exhibition



Bicsi

Operational in Extreme Cold and Extreme Heat



2018 BICSI Fall Conference & Exhibition



Bicsi

Long-range Video Surveillance



2018 BICSI Fall Conference & Exhibition



Thermal

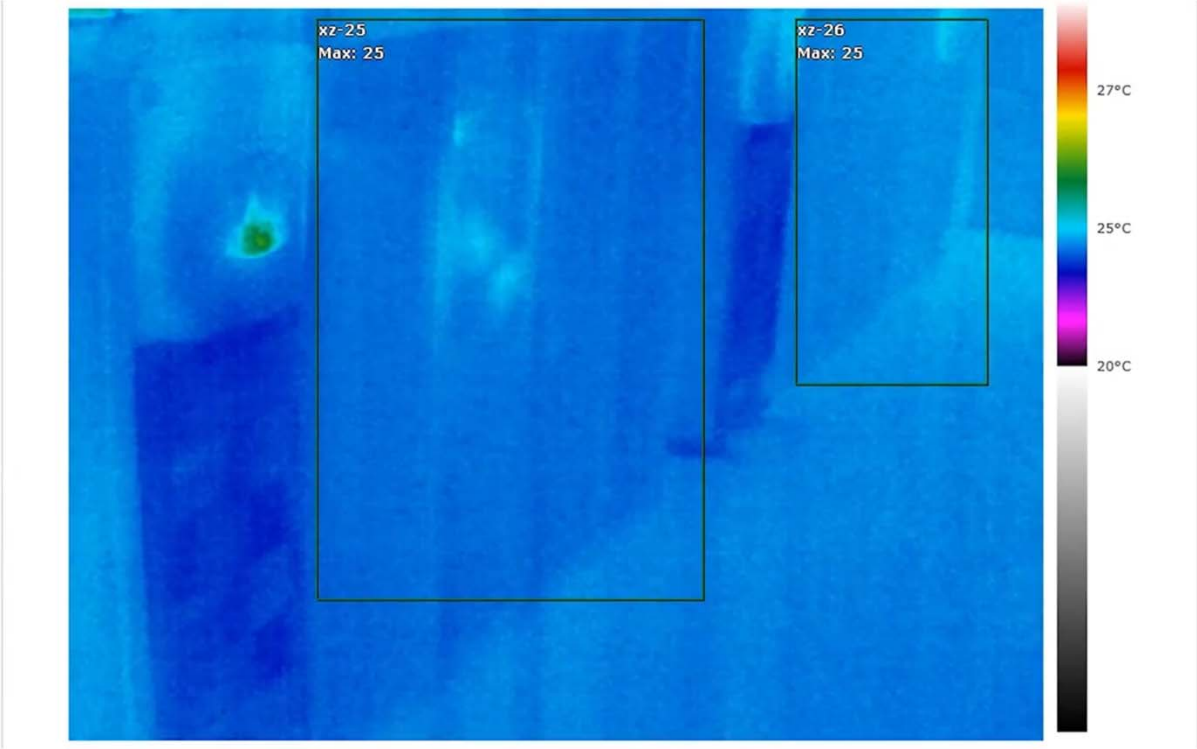

Video Compression



Intelligent Applications

- > Edge processing
 - Access to applications **at the edge**
 - Present a wide range of intelligent applications for efficient surveillance, data analysis and business management
 - Open platform allows for application development partners to meet specific needs
- > Adapting to the IoT world will require the ability to connect in ways beyond standard security
- > Almost all of the enterprise customers desire customization to accomplish business goals

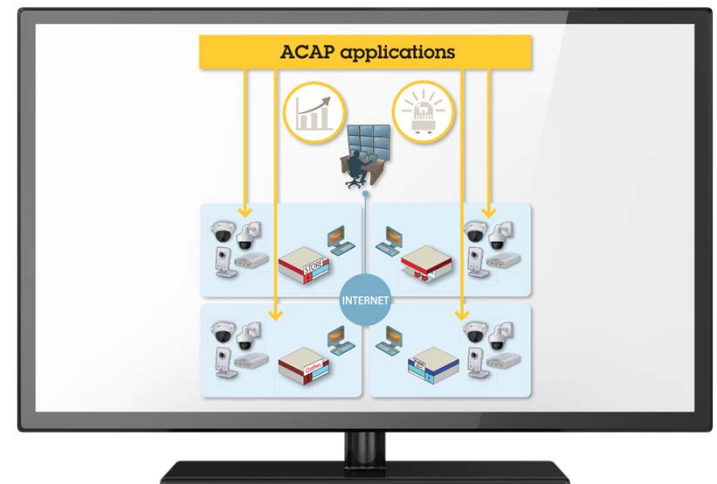

Decoding

“Detect”



2018 BICSI Fall Conference & Exhibition



Bicsi

PoE Decoders

- Decoding
 - Connecting digital monitors to display live video from network cameras

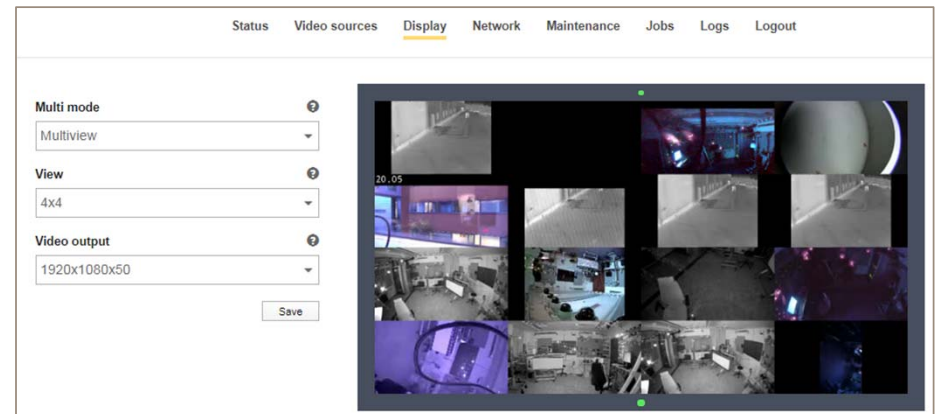

Access Control

“Delay”



2018 BICSI Fall Conference & Exhibition



Bicsi

PoE Controllers

> Door connections

- Request-to-Exit
- Door Position Switch
- Card Reader
- Emergency Door Release
- Power for Electric Lock (Strike)

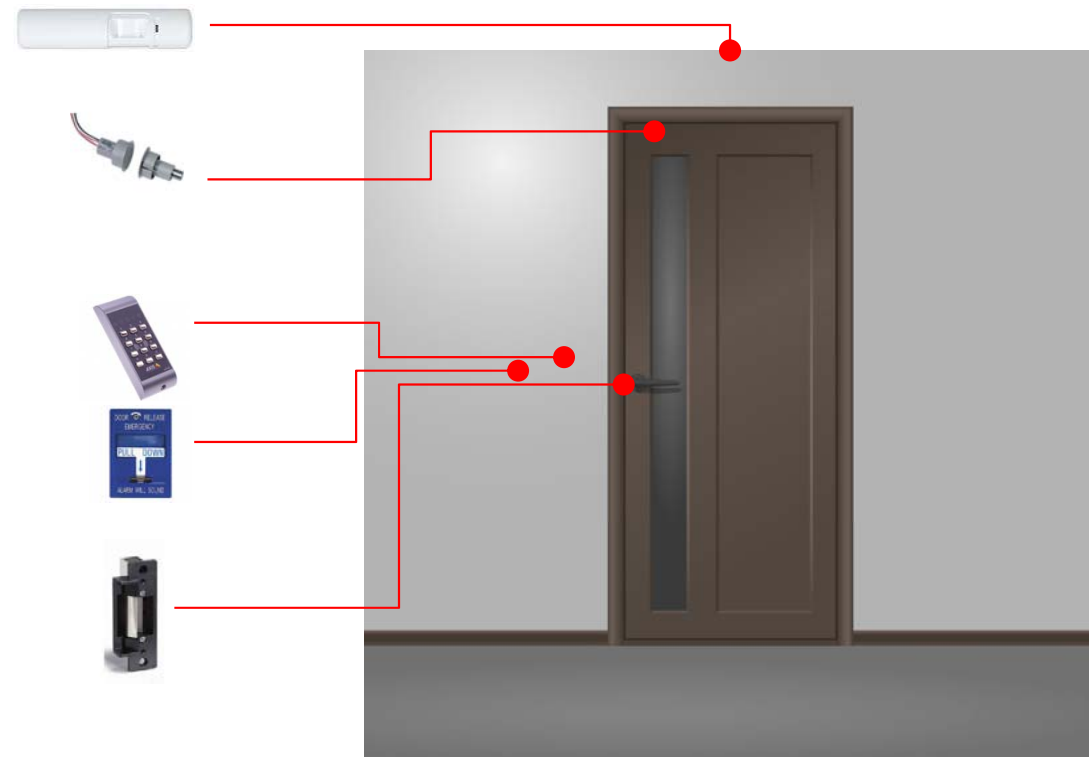

PoE Door Devices

- RFID Door Readers
- Biometric Readers
- Door Locking Hardware
- ~~Electromagnetic / Door Strike~~



PoE Controllers

- > Powers door devices
 - Request-to-Exit motion
 - Card Reader
 - Power for Electric Lock (Strike)
- > Runs autonomous from software
 - Controls access to access portal
 - Stores cardholder records
 - Stores time schedules
 - Stores user permissions
 - Alarm and Relay Linking
 - Event recording

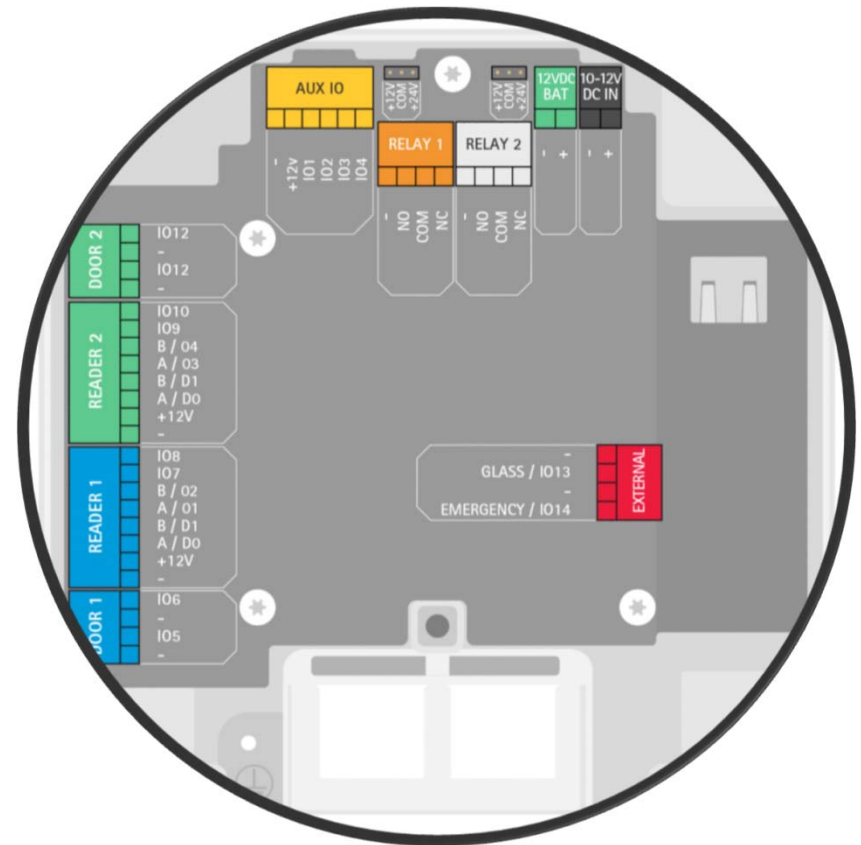

IP Intercom

Devices for “Communication”



2018 BICSI Fall Conference & Exhibition



Bicsi

Types of IP Intercom

- Facility
 - Building entrance
 - Front / Employee / Dock doors
 - Remote building Remote gate
 - Parking Garage
 - Parking Lot
- Residence
 - Entry gate
 - Apartment call center
- Management



SIP Communication – An Overview

- **Session Initiation Protocol**

- SIP is the standard protocol used in Voice over IP (VoIP) applications and unified communication platforms.
 - Initiate, maintain and terminate sessions between clients
 - Usually audio, but video too
 - SIP phones, Intercom devices, Audio, Radio-over-IP, etc.



IP Audio

La ...la ...la ...la



2018 BICSI Fall Conference & Exhibition



Bicsi

PoE Loudspeakers

- “See something ... Say Something”
 - Extending the reach of a security program
 - The loudspeaker can be remotely accessed and/or play a pre-recorded audio file when it is manually or automatically triggered (alarm event)
 - Compatible with major video management software and SIP-based VoIP systems
 - Address individual speaker from anywhere with network connectivity



PoE Speakers

- PoE (IEEE 802.3af/802.3af Type 1 Class 3)
- A complete audio system
 - Speaker
 - Amplifier
 - Signal processing, equalization
 - Microphone
- Streaming audio
- Customized announcements



PoE Speakers

Traditional analog speaker solution

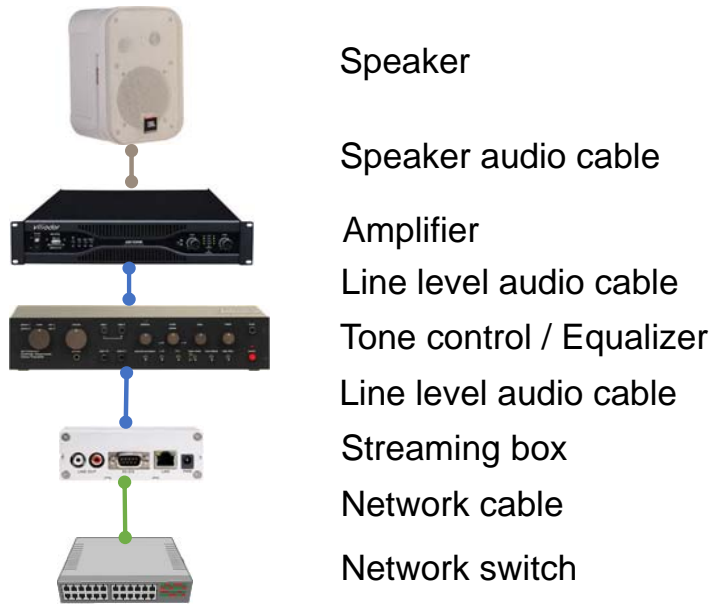

Network speaker solution

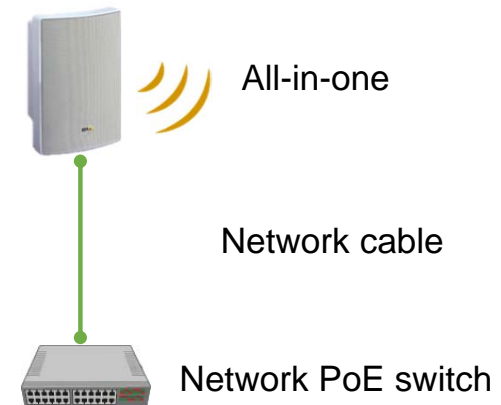

IP Lighting



2018 BICSI Fall Conference & Exhibition



Bicsi

PoE Lighting - Security

- > Security
 - Visible Light
 - 802.3af compliance – draws 12W
 - IR (850nm or 940nm)
 - 802.3af compliance – draws 12W



iluminar



2018 BICSI Fall Conference & Exhibition



Bicsi

PoE Lighting - Buildings

- > Intuitive sensors to learn and interact
 - Occupancy – turn on and off
 - Dimming – adjusts to ambient lighting
 - Color temperature
 - Business analytics
- > Efficient
 - Dramatic energy savings
- > Installation
 - Eliminate heavy duty copper wire and conduit used for traditional lighting
- > Flexibility
 - Ability to easily move or replace fixture

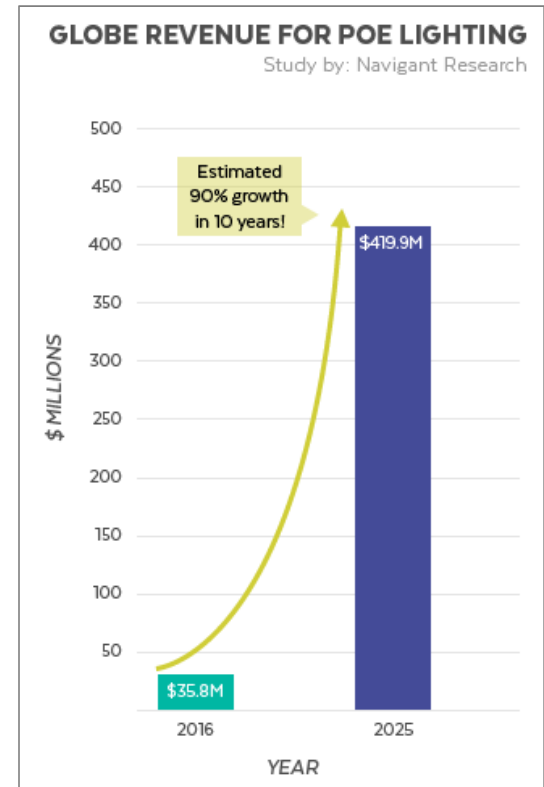

Cyber

IoT and the precautions for networked devices



2018 BICSI Fall Conference & Exhibition



Bicsi

High Profile Breaches Make Headlines

The New York Times

Millions of Anthem Customers Targeted in Cyberattack
– The New York Times, Feb 2015

THE HUFFINGTON POST

Apple Hacked: Company Admits Development Website Was Breached
– Huffington Post, July 2013

CNN

South Carolina taxpayer server hacked, 3.6 million Social Security numbers promised
– CNN, Oct 2012

theguardian

Facebook hacked in 'sophisticated attack'
– The Guardian, Feb 2013

Bloomberg

Target's Data Breach: The Largest Retail Hack in U.S. History – Bloomberg, 2014

THE WALL STREET JOURNAL.

NASDAQ Confirms Breach in Network
– The Wall Street Journal, Feb 2011

WIRED

Chinese hacking of US media is 'widespread phenomenon'
– Wired, Feb 2013



2018 BICSI Fall Conference & Exhibition



Bicsi

ATTACKS TODAY

(since 12AM PST)

4,713,387

ATTACKS YESTERDAY

1,836,876

TOP TARGETS BY COUNTRY

-  India
-  USA
-  Indonesia
-  Australia
-  Mexico
-  United Kingdom
-  Brazil
-  Norway
-  Philippines
-  China

USA

THREAT STATS

Last Week | Last Month

Average Infection Rate



15.75%

Most Frequent Attack Source

USA

Infecting Malware Types

Malicious file transfer 1.4%

LEARN ABOUT CHECK POINT
 THREAT PREVENTION SOLUTIONS >



TIME	ATTACK	SOURCE	TARGET
13:35:42	REP.TC.igmrw	CA, USA	Greece
13:35:42	REP.TC.fgmrw	CA, USA	Greece
13:35:41	Emotet.TC.gzl	Azerbaijan	Greece
13:35:41	Emotet.TC.hvr	MO, USA	Greece
13:35:41	Emotet.TC.azi	NY, USA	Greece

 Source

 Target

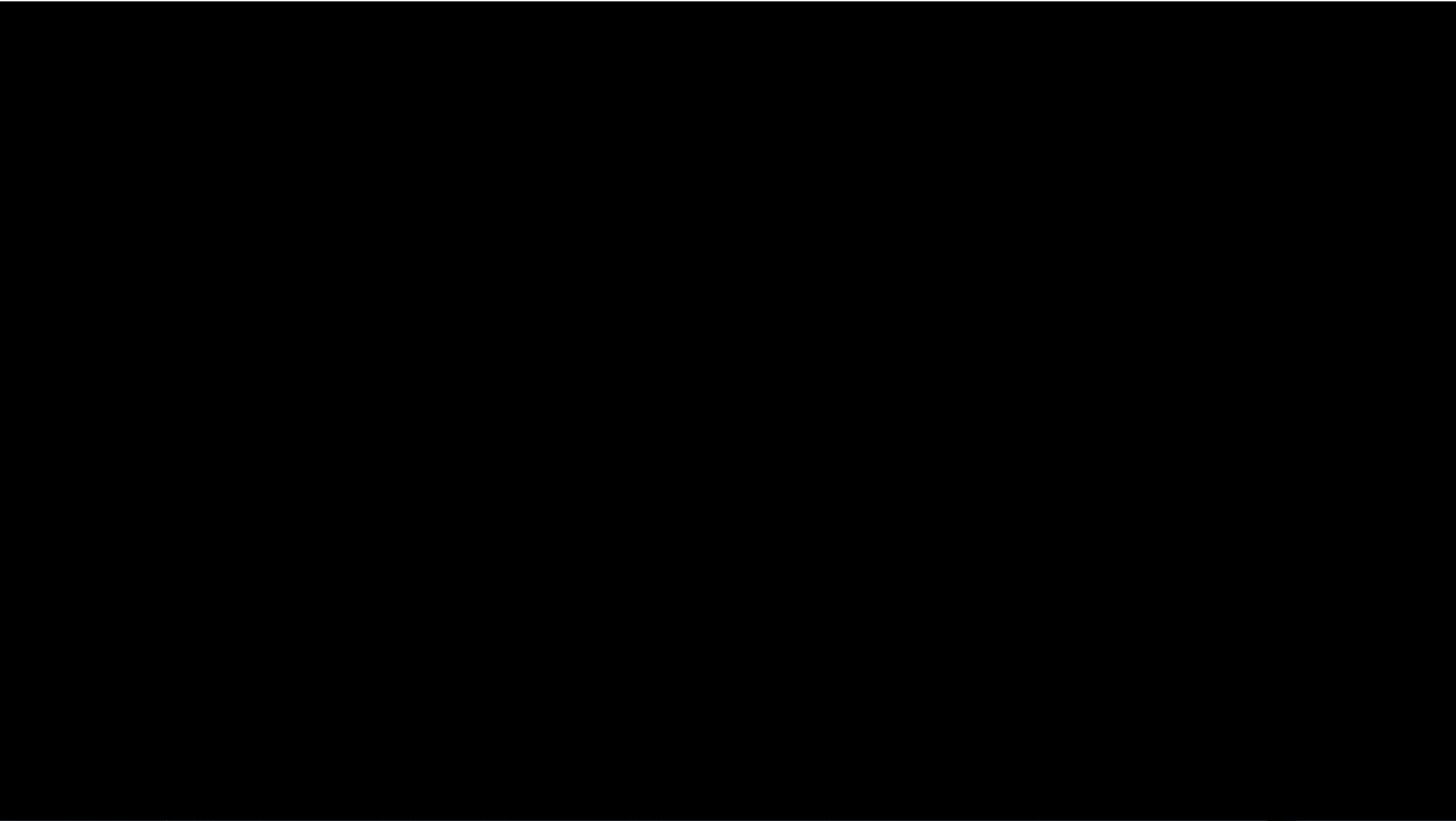

What is Cybersecurity?

- Cybersecurity refers to a set of techniques used to protect the integrity of networks, programs and data from attack, damage or unauthorized access.
- Cybersecurity involves mitigating risks by reducing the attack surface area, or more simply – by reducing exposure.
- Cybersecurity cannot be defined as a single product or tool.



What is Cybersecurity?

- It is important to understand that 100% protection against intrusion is very hard to achieve, if indeed possible at all.



IoT and Network Device Cybersecurity Concerns

- > **Unsecured endpoints used as a point-of-entry on the network**
- > *Poor password complexity protocol*
- > *Open ports and unused services*
- > *Man-in-the-middle packet capture*
- > *Malware*
- > *UDP-flood, DoS, DDoS*



Where should I start?

- To protect a network against attack, various security controls can be implemented. These controls are safe guards or countermeasures to avoid, detect, or mitigate secure interest to **physical property, networks**, appliances, servers, information, or other assets.



Where should I start?

- In a security system, the main areas to focus on are:
 - **Physical exposure** - protecting the system hardware
 - **Network exposure** - preventing unauthorized access
 - *Service exposure* - preventing access via unused services
 - *Encryption* - securing transmission to/from appliance
 - *Credentials* - the use of robust credentials
 - *Authentication* - authentication policies (certificates)



Where should I start?

- Physical

- The first line of defense is the physical protection of the primary access points to your network
- Various measures may include:
 - Secure network equipment and servers
 - Mounting appliances out-of-reach
 - Using tamper switches
 - Using vandal-resistant enclosures
 - Use protective shielding for exposed cabling
 - Protect the cable ends and open ports



Where should I start?

- Network

- The second line of defense is protecting your network infrastructure from unauthorized access
- Various measures may include:
 - Protect the perimeter
 - Control access to the facility - Manage who comes and goes
 - Video Surveillance – Record the identity of each person
 - Protect the interior
 - Conceal cabling - Structured cabling should be out of sight
 - Control access from public and employees
 - Physically secure MDF/IDF locations
 - Control access to internal sensitive areas
 - Security at the cabinet level

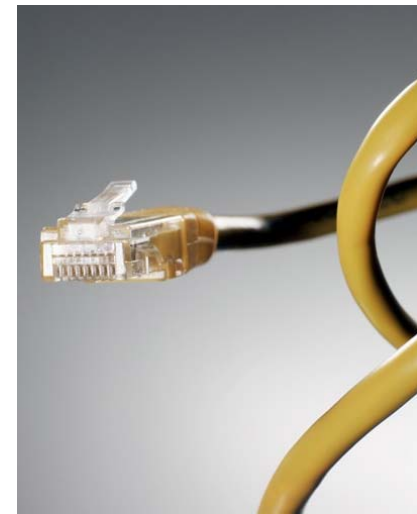

Final Thoughts ...

- IoT drives appliances to the network
 - Integration between appliances transitions from “Analog” to “Digital”
 - IPV6 implementation is absolutely necessary
- PoE will continue to drive edge-based technology
 - Security industry is quickly adapting and innovating
- PoE will challenge the status-quo
 - Video / Audio / LED Lighting / Automation / Smart buildings / BYOD
- PoE standards will recognize higher power requirements
- PoE requires different design considerations
- Cyber threats will keep you up at night



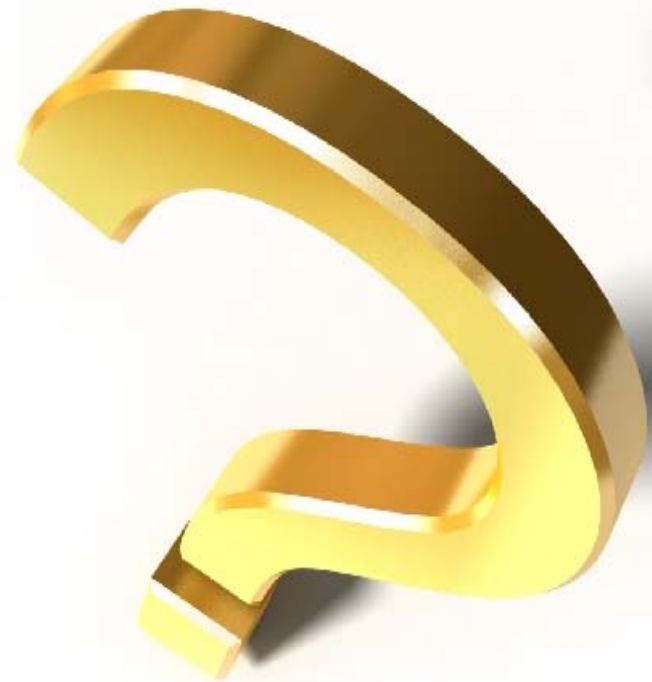

2018 BICSI Fall Conference & Exhibition



Bicsi



Thank you!



2018 BICSI Fall Conference & Exhibition



Bicsi