

Grounding and Bonding Fundamentals That Can Prevent Downtime and Outages

David Brender, P.E.

BrenderAssociates.com

Tel: 561-894-8901

Agenda

- 1. National Electrical Code® minimums and going beyond the Code**
- 2. Considerations for sensitive equipment**
- 3. Many case histories we can learn techniques from, good and bad**
- 4. Recommended wiring, bonding, grounding techniques**

What is Poor Power Quality

- Poor power quality...

is evidenced by characteristics of the incoming power to a device that deviate from the customary “pure” 60 Hz sine wave, and that can affect reliable and safe operation of the sensitive equipment

What The Equipment Wants

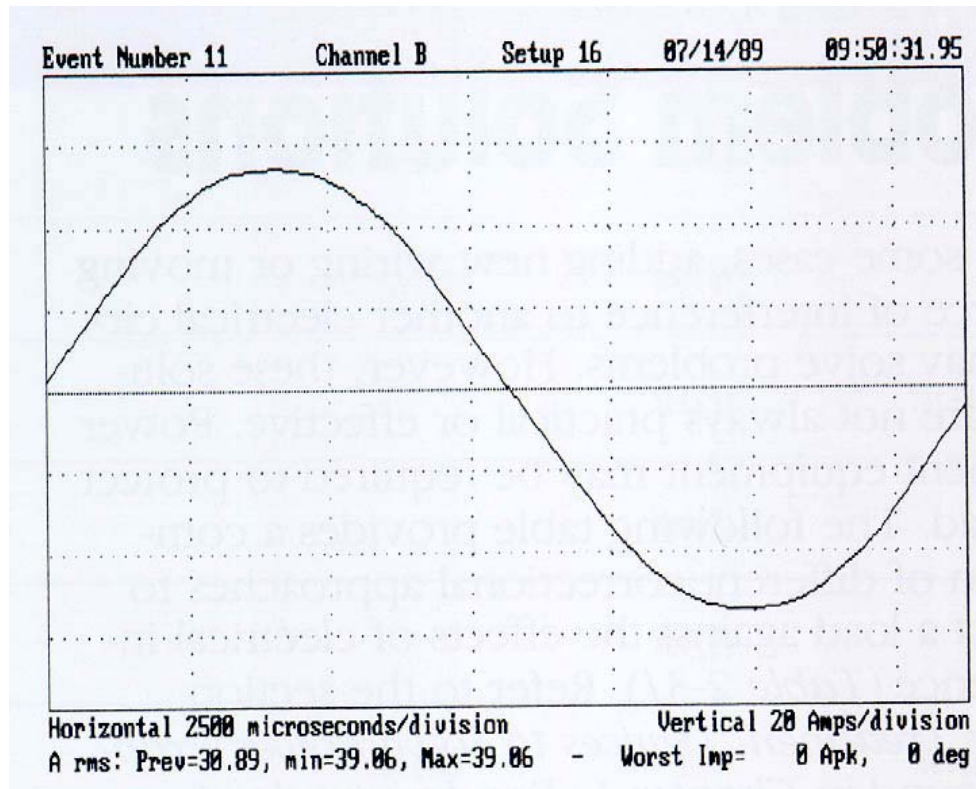

What The Equipment Sometimes Gets

- Flat-topping
- VSD notch
- Amplitude varies
- Frequency varies

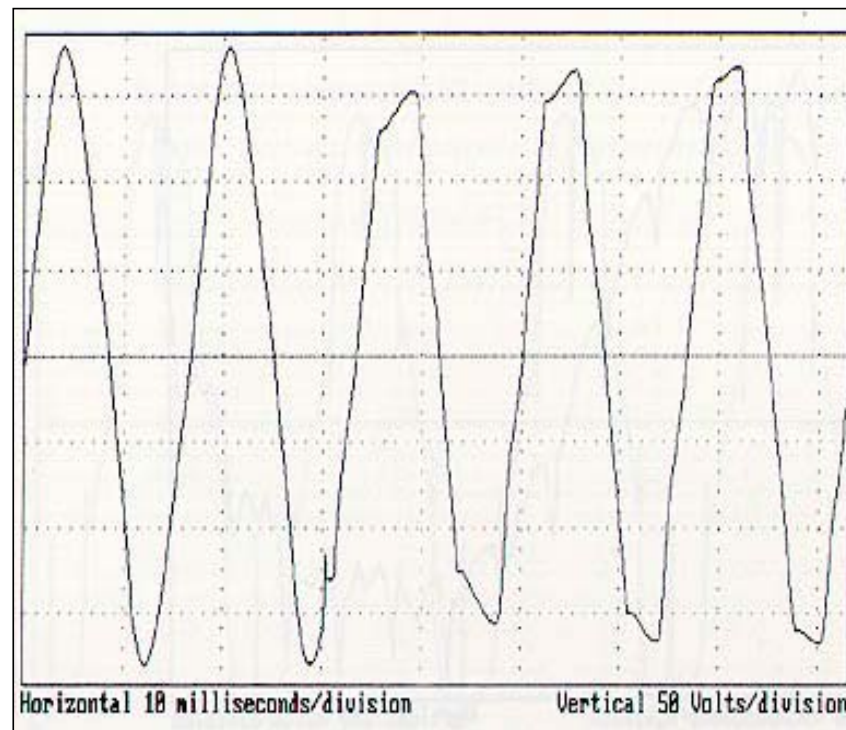

We Are Going to Discuss

Elements of building infrastructure that can alleviate or cure power quality problems before they affect operations:

- **Grounding**
- **Bonding**
- **Circuiting**
- **Lightning design considerations**

You should be able to conduct a preliminary walk-around audit after this presentation or realize it's time to hire an expert.

Equipment More Sensitive

- **Micro circuits are getting faster (radio frequency range)**
- **Microprocessors more ubiquitous**
- **Circuits are getting smaller**
- **Operating voltages are lower**

Old vs. New

What used to be acceptable service characteristics are no longer sufficient

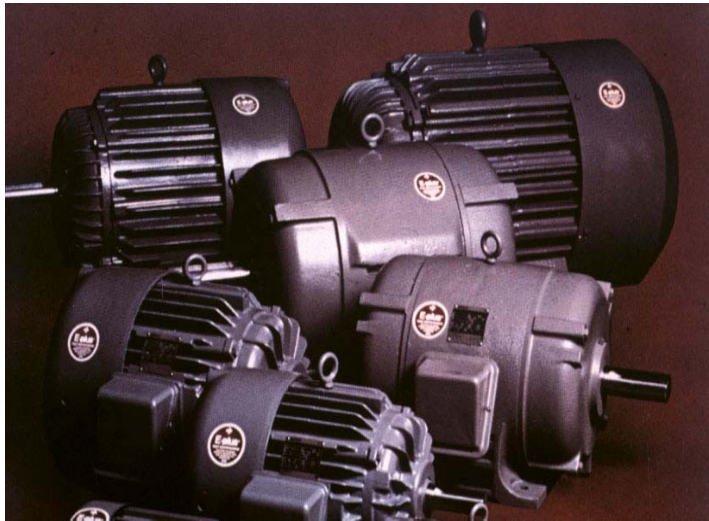

The Real Cost

The real cost of poor power quality is in lost productivity (downtime).

- **Estimated at \$15-30 billion per year plus in US**
- **Average cost of a data center outage \$740,357 in 2016**
- **Exceeds \$1 million/yr. at some buildings**

- E Source and Penton

Is The Computer a Problem?

or is it the way it's wired?

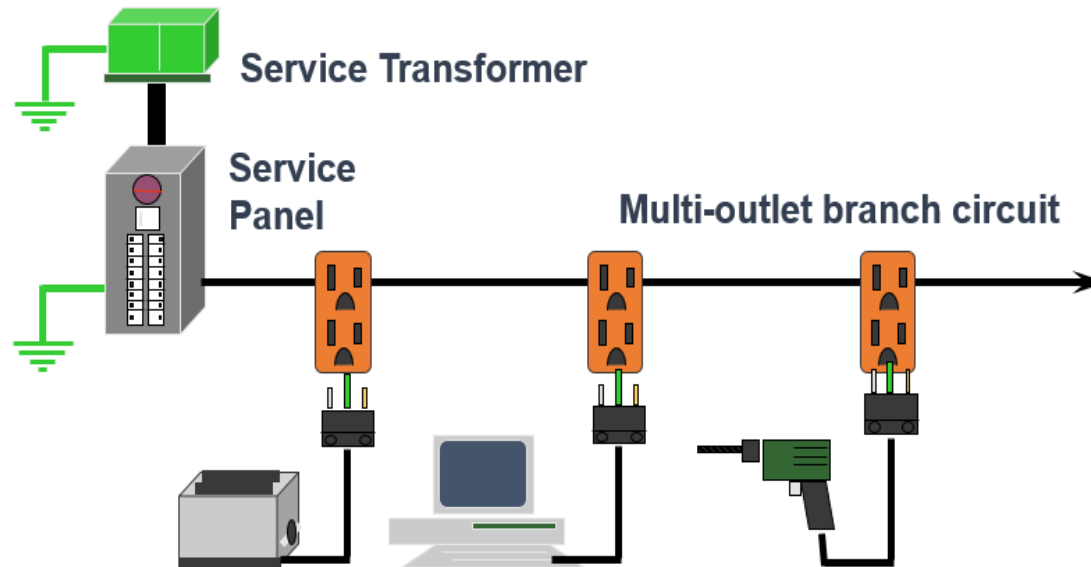

All Types of Loads on Same Panel

PANELBOARD/PANNEAU/TABLERO

DATE: _____

SOURCE		LOAD / CHARGE / CARGA	
CIR		CIR	
1	Elevator main	2	Lobby A H U
3	disconnect	4	
5	Hyd. motor	6	
7	Lobby A/R	8	Surge
9	condenser unit	10	Protection
11	out Back	12	unit
13	Parking lot	14	Hot water
15	Light poles	16	Heater
17	Parking lot	18	spare
19	Light poles	20	South Stair way LTS
21	OUTSIDE front GFI	22	SPare
23	N+S GFI	24	North Stair way LTS + Emergency LTS
25	GFI under	26	Elevator Cab LTS
27	Photo Cell	28	Fresh Air make up Fan
29	Entry lobby GFI	30	Time clock
31	Fire Alarm Booster Pnl.	32	Elevator PIT QFI
33	Fire Alarm Pnl.	34	Elevator PIT LQTS
35		36	

Power Problems Are Mainly Internal

Most power quality problems are related to
grounding and
neutral size issues

Over 80% are internally caused

source: EPRI

Erratic Operation or Downtime

Power Quality issues can lead to erratic operation of sensitive electronic equipment (data errors, lockup, false images in medical diagnostics, premature failures, downtime, nuisance tripping, etc.)

Motor Failures

Premature burnout of motor windings

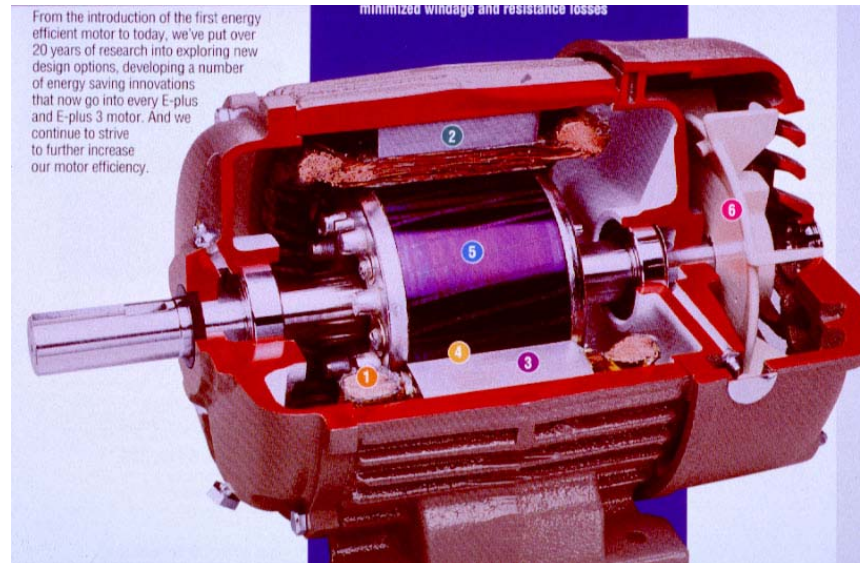

Effects of Poor Power Quality

In a room full of equipment, how do you find this?

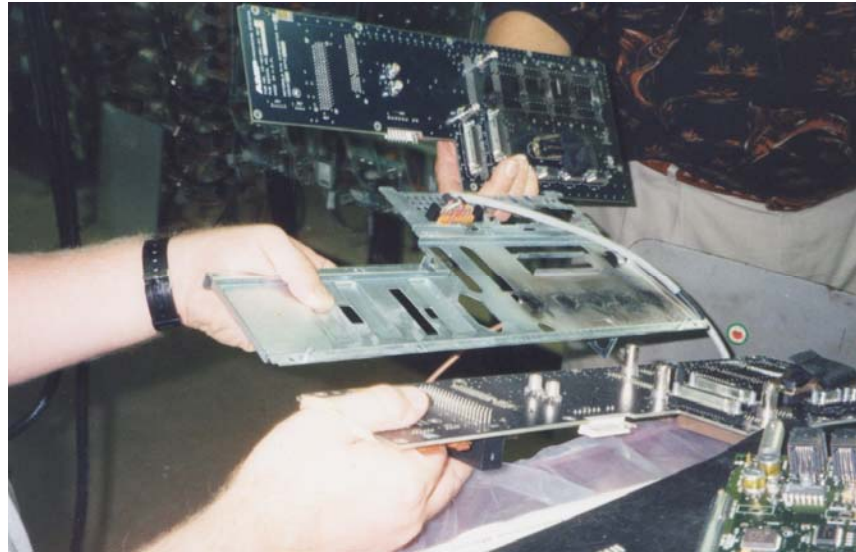

Two Types of “Grounding”

- **System Grounding**
- **Equipment grounding (bonding)**

The Term “Ground”

- Article 100: Ground is defined as the earth.

“Grounding”

Grounded (Grounding). Connected (connecting) to ground or to a conductive body that extends the ground connection.

The ground path can carry current in the event of a fault.



System or Exterior Grounding

Needed for:

- Establishing a voltage reference
- Discharge high transient voltages (esp. lightning)
- Static Discharge
- Personnel Safety

“Bonding”

The intentional connection of normally non-current carrying parts of equipment together

It does not reference connection to earth, but usually is taken to mean such.

The two terms (“grounded” and “bonded”) are frequently used interchangeably.

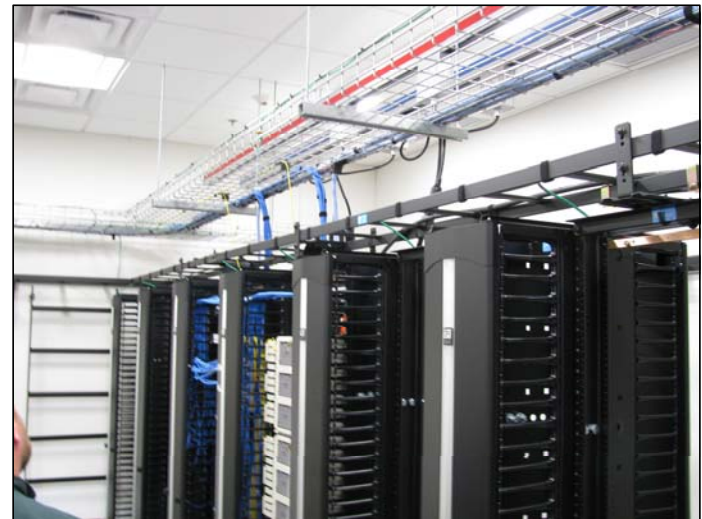

National Electrical Code® Limitations

Sec. 90.1: The purpose of the NEC is the PRACTICAL safeguarding of persons and property from the hazards resulting from the use of electricity.

Compliance with the Code results in an installation that is essentially safe, but may not work efficiently or adequately.

NEC Is Bare Minimum Needed for Safety

Good starting point, BUT..

NEC is NOT a PQ Code

NEC is NOT a lightning Code

NEC is NOT a good grounding Code

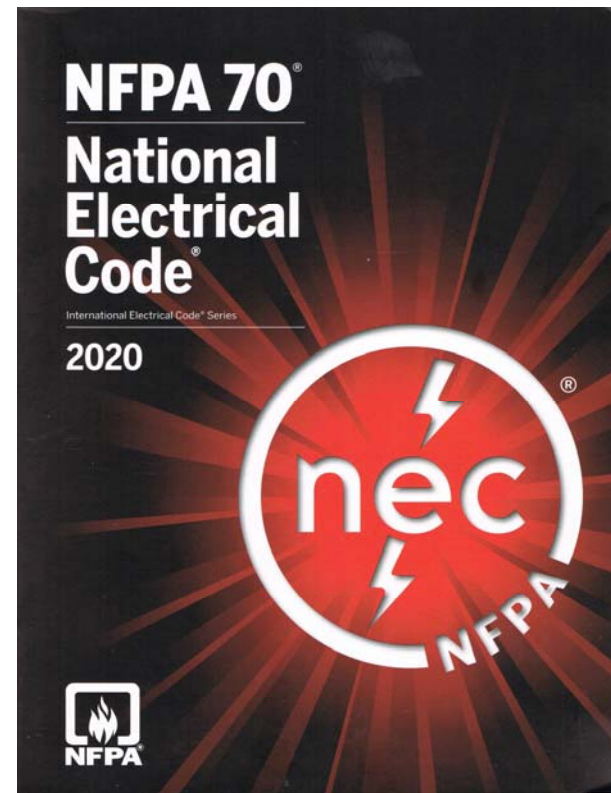

Grounding Below Moisture Level?

- **250.53 (A)(1)** If practicable, rod, pipe, and plate electrodes shall be embedded below permanent moisture level.

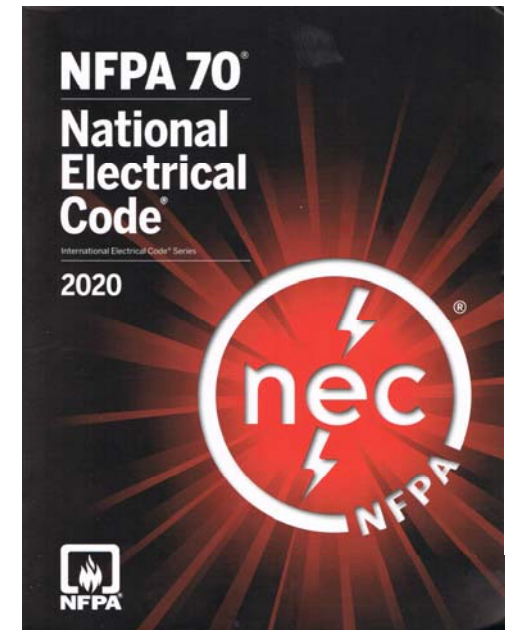

NEC Does NOT Require 25 Ohms

Alludes to 25-ohm standard BUT DOES NOT REQUIRE SUCH

250.53 (A)(2): A single rod, pipe or plate shall be supplemented by an additional electrode..

NEC “Alludes” to 25 Ohms

BUT

exception:

Exception: If a single rod, pipe, or plate grounding electrode has a resistance to earth of 25 ohms or less, the supplemental electrode shall not be required.

There are no testing parameters.

No spacing specified. No resistance specified.

Thus, if two rods are installed, you’re done!

A second rod is cheaper than measuring!

NEC Allows 6 Ft. Spacing

- **250.53 (A)(3) Supplemental Electrode.** If multiple rod, pipe, or plate electrodes are installed to meet the requirements of this section, they shall not be less than 1.8 m (6 ft) apart.

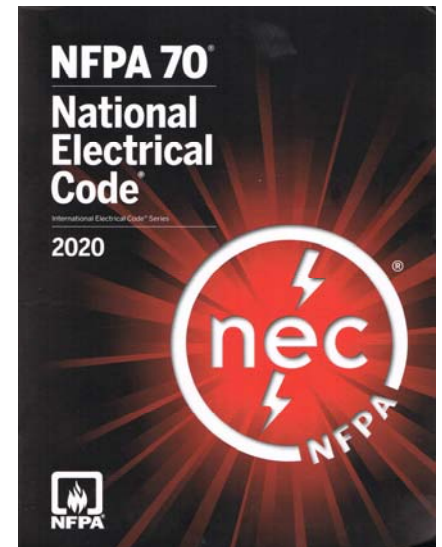

Plate Electrodes Are Fully Recognized

- **250.52 (7) Plate electrodes...**shall expose not less than 2 ft² of surface to exterior soil.
- NEGRP showed plate electrodes are virtually useless.



NEC Allows 30 Inch Depth

- **250.53 (F) Ground Ring.** The ground ring shall be installed not less than 750 mm (30 in.) below the surface of the earth.



Ring Grounds Allowed as Small as #2 AWG

- **250.52 (A)(4) Ground Ring.** ..encircling the building ...in direct contact with the earth consisting at least 20 ft. of bare copper conductor not smaller than #2 AWG.

4/0 to 500 kcmil commonly found



Better Standard: IEEE Emerald Book

- **ANSI/IEEE 1100**
Recommended practices are needed
for power quality.

800-678-IEEE

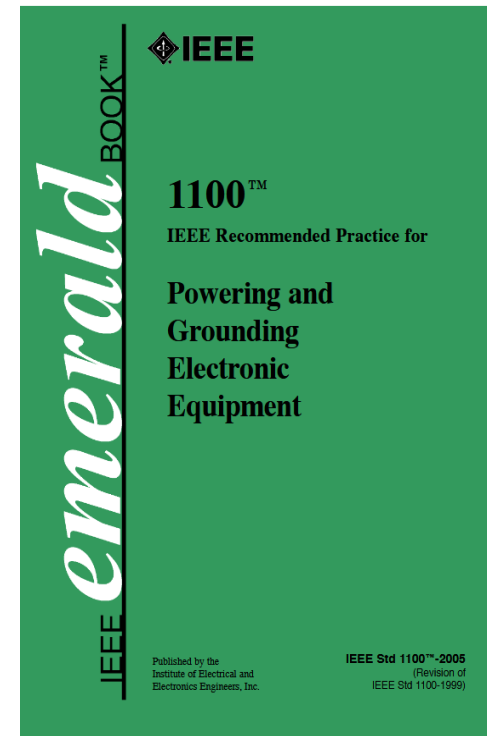

System Grounding

Desired Grounding Resistance:

- 5 ohms or less desired for power quality
- Many mfgs. specify under 2 ohms
- IEEE recommends 1-5 ohms (Green Book)

Ground Rod Spacing

Concentric Shells of Earth Surround Rod

Varies with
rod length &
soil conditions

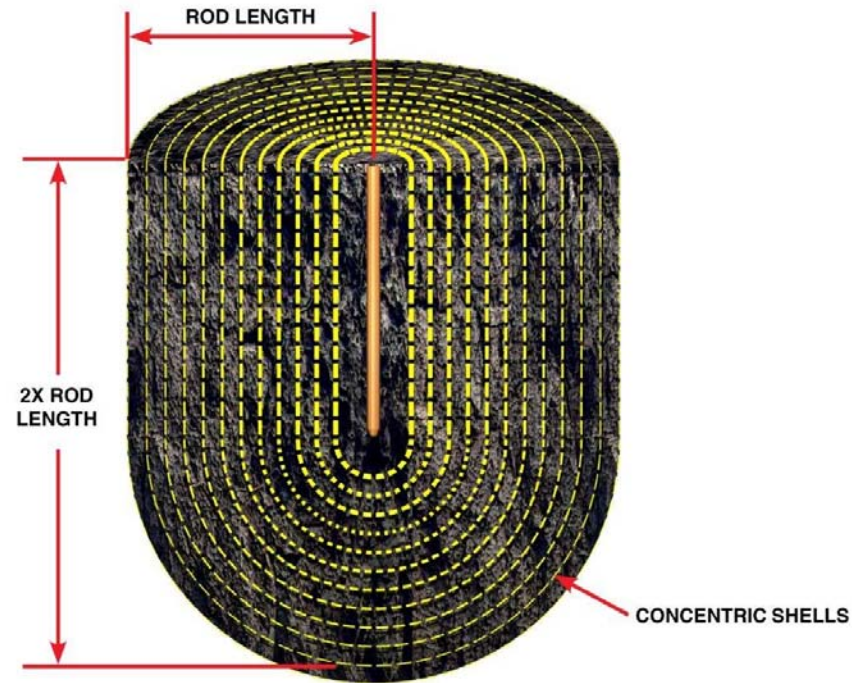

Overlapping Spheres of Influence

Lowering Ground Resistance

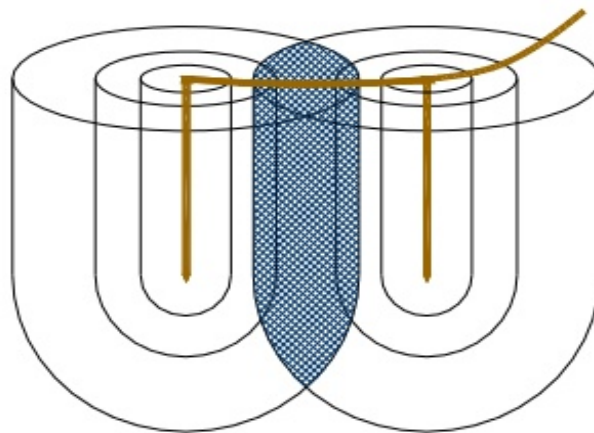

Concentric Shell
Overlap Decreases
Efficiency of
Ground Rod
Resistance

Rod Spacing

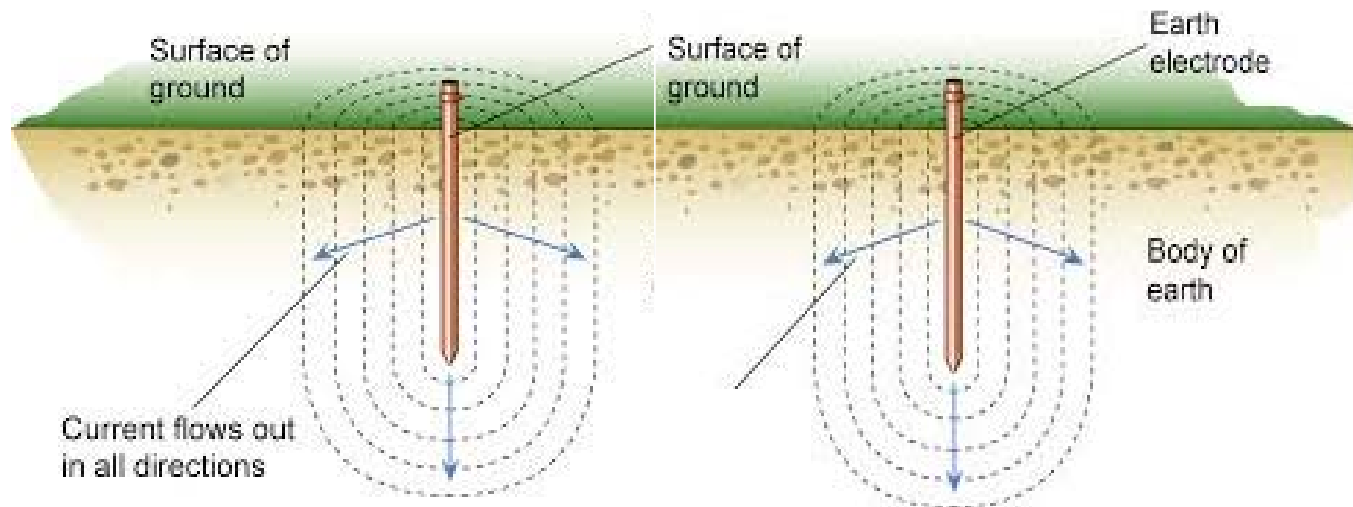

Minimum spacing is 2X the rod length

Poor Example of Ground Rod Spacing



We Will Discuss Spacing and Testing
In More Detail Later

Orange County, FL 911

**Headquarters
Apopka, FL**



Source: Power & System Innovations, Inc.

Case History

13 transmitter sites
Surrounds Orlando, FL
including Disney World

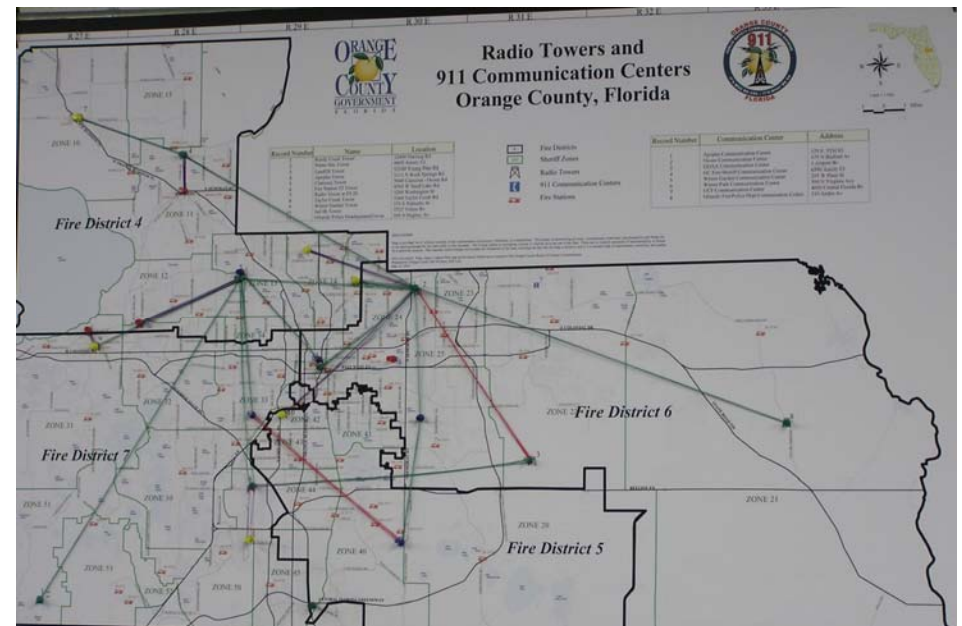

Headquarters Tower

280 foot tower

3 sets of 5 guys each



Equipment Damages

\$100 K/yr. damage at Apopka alone
Not including downtime



Internal Arcing

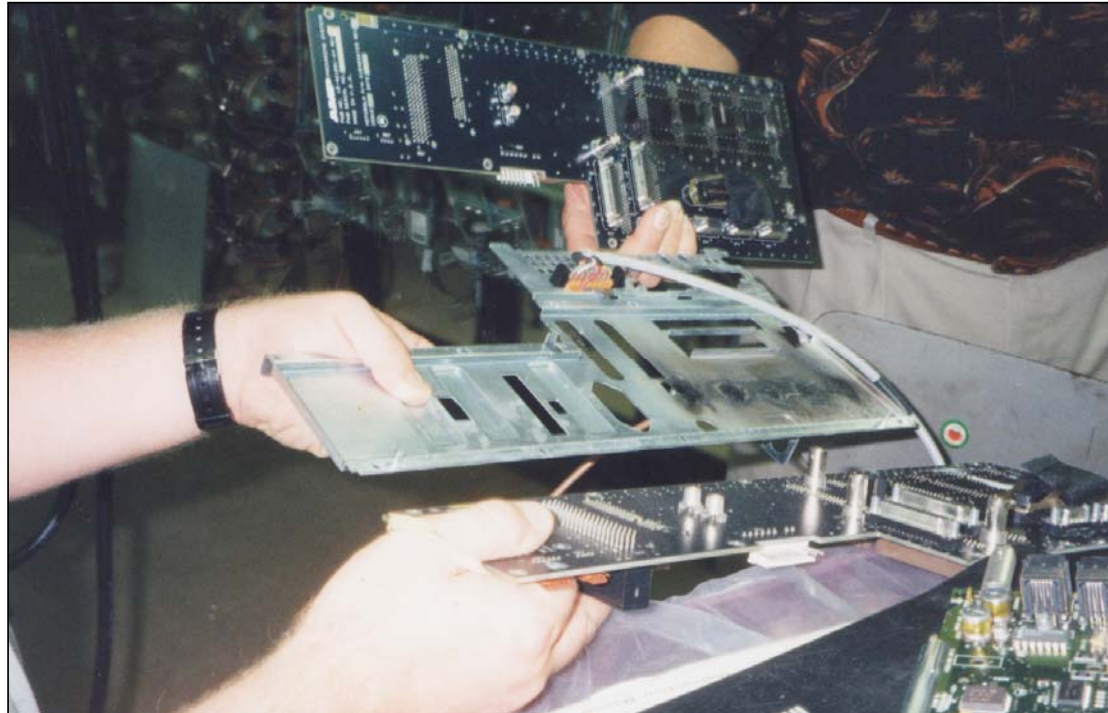

3 Independent Grounds

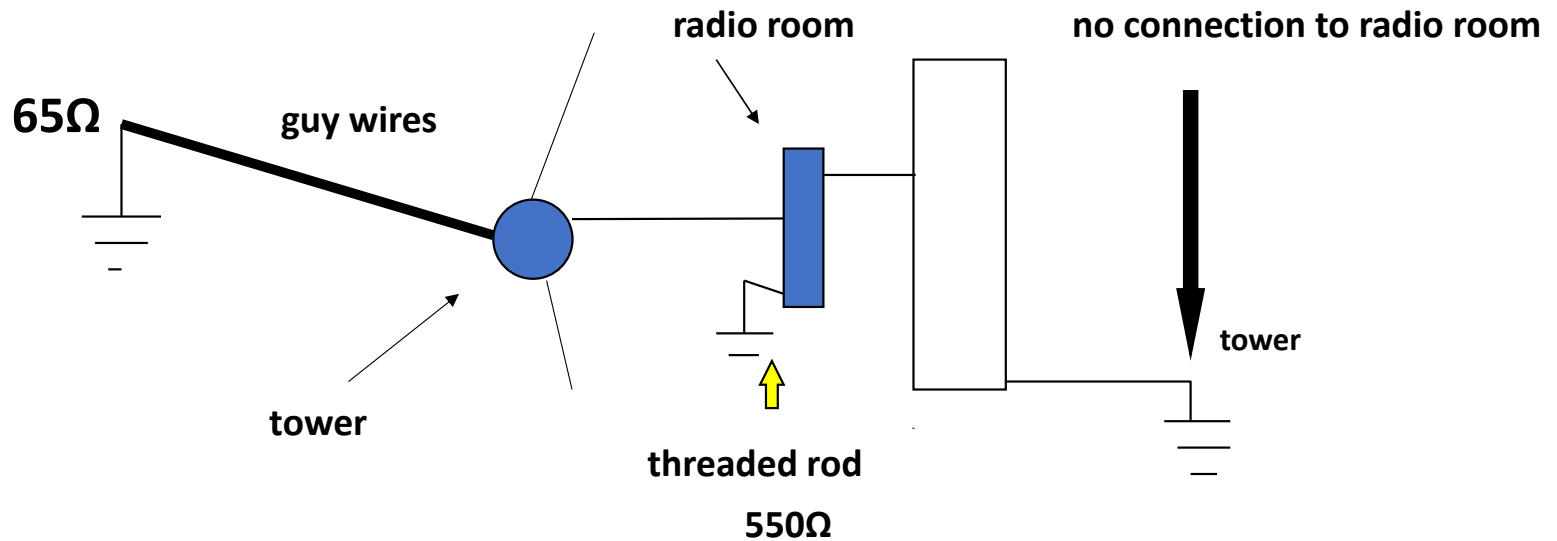

3 ground connections meant 3 potentials

Important step was connecting all the separate grounds into ONE system

Radio Room

Several \$Million
equipment



Ungrounded Equipment Cabinets

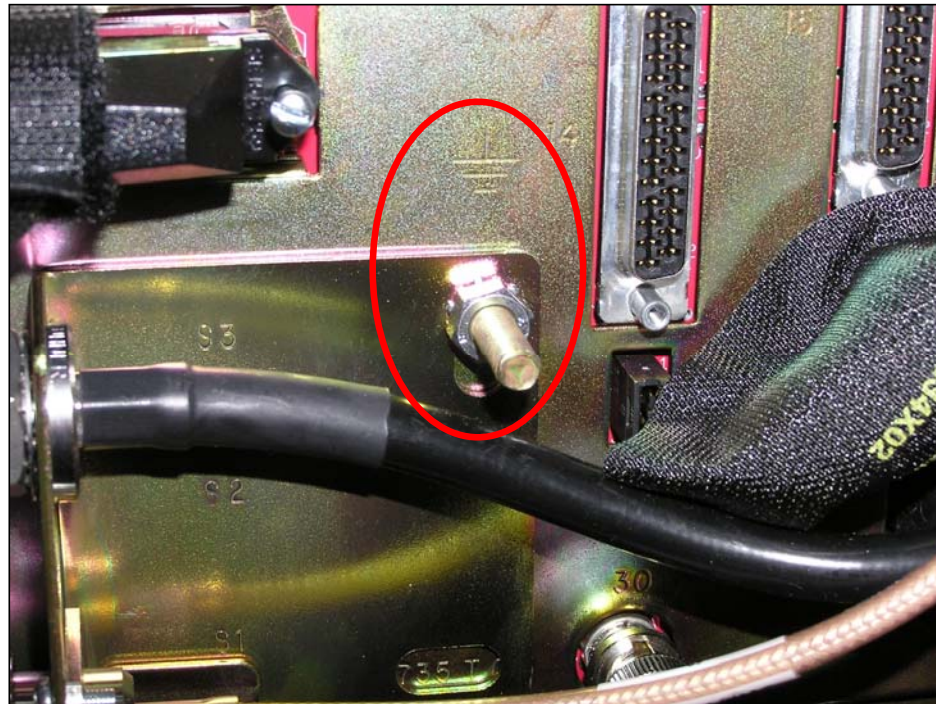

In Radio Room

Everything bonded together
Dual halo ground rings

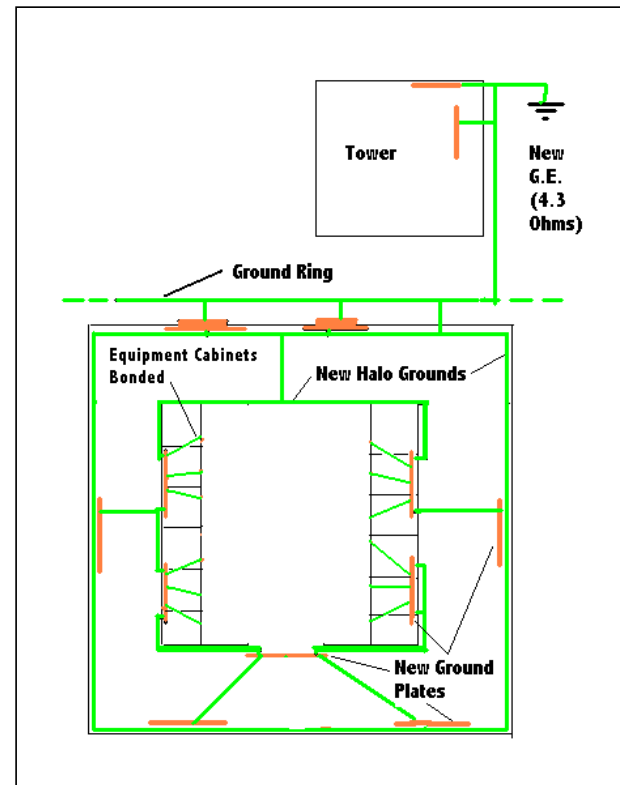

Outside Bulkhead

Only ONE Cu strip
connected to electrode



Grounding Electrode at Apopka

Main electrode for tower and equipment was all-thread rod



Original Ground Resistance

Measured 550 ohms



Coax Grounding

- New busbar for coax shields
- Addressed corrosion

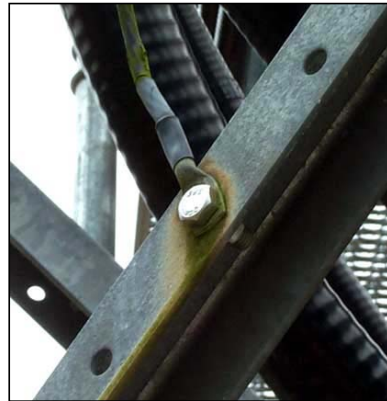

Apopka Tower Grounding

Among the retrofits:

Deep (60 ft) electrode UNDER TOWER
supplements tower grounding

Lightning does not turn 90°



Outside Bulkhead

strip bonded together and to ring with 4/0



Halo Rings

All equipment now bonded to overhead buses

Buses tied to halo rings

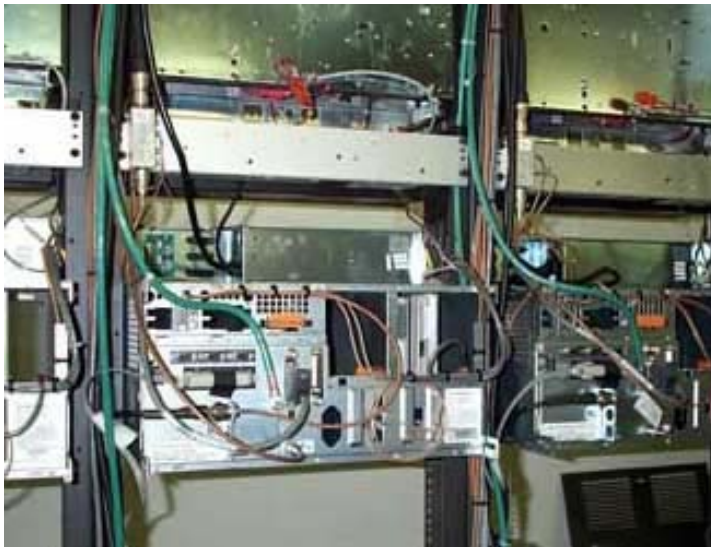

Reedy Creek

**Remote repeater
near Disney World**



Reedy Creek

More real estate to work with



Reedy Creek

Grounding layout: double rings plus deep electrodes

Ring is 4/0 AWG

Electrodes 120 ft. deep

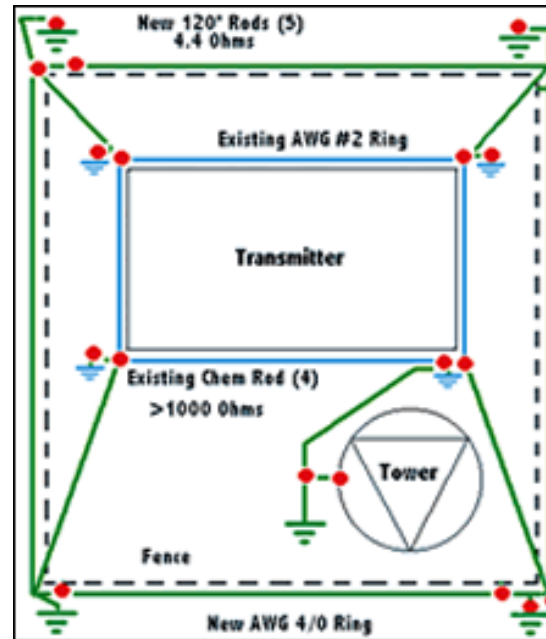

New Grounding Resistance 3.5Ω

Each electrode
< 5 ohms
independently



Sweeping Turns

Note wide, large diameter turns. 8" should be minimum bend radius.

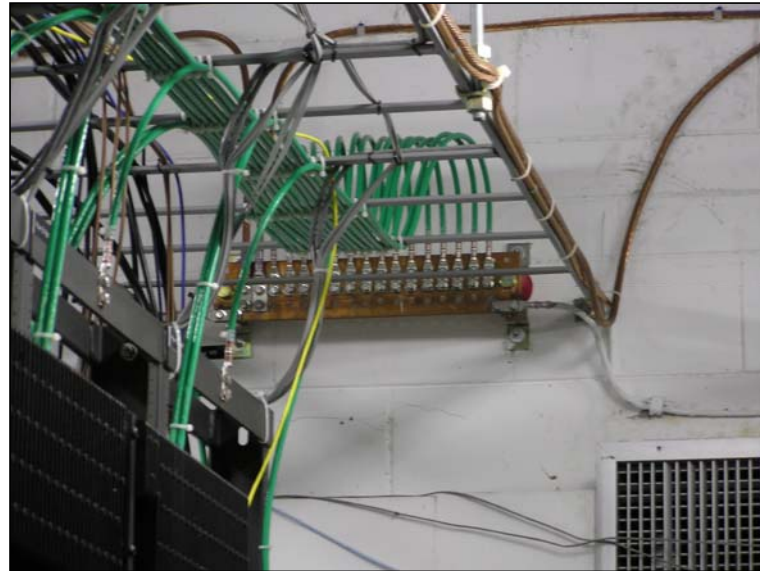

Replaced Connections

How many wires can you fit in a split-bolt?

This is an example of
“daisy chaining”



More Ungrounded Equipment at Apopka

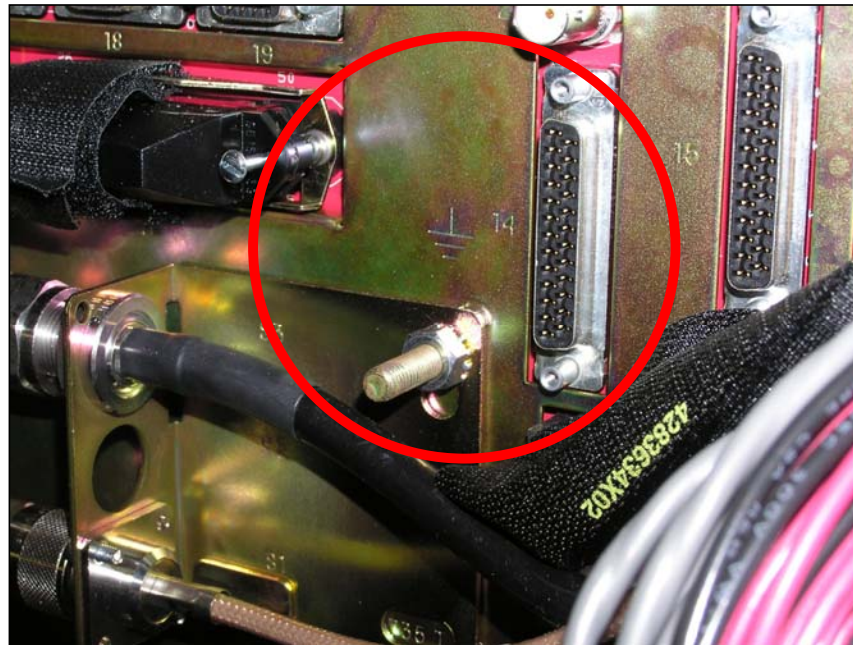

Lightning Means Vibration

Lock washer, double nuts
recommended

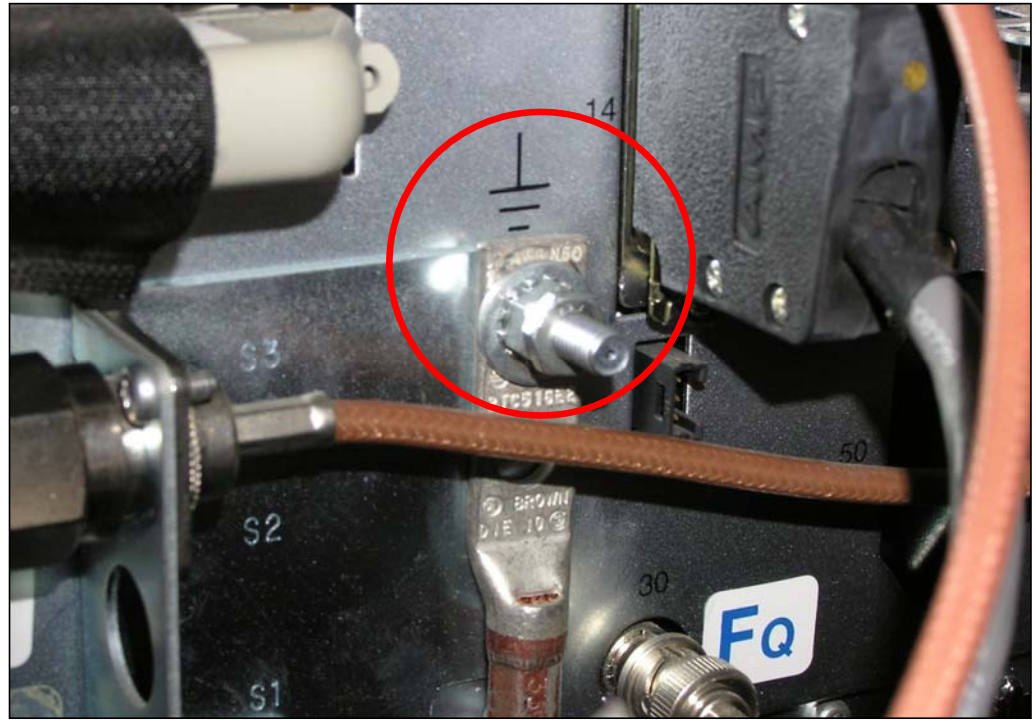

Since Retrofit

- Thousands of events recorded
- One strike witnessed

- **NO Downtime! No equipment damage.**
<\$500,000 cured \$1 million damages

6-mos. to 1 year paybacks common

Major Lessons Apply to All Installations

**3 different contractors
meant 3 separate grounds**

- electrical
- radio room
- tower

**No one party had overall
responsibility**

You must inspect work



Angel Fire Ski Resort Example



Angel Fire Ski Resort

The Economic Value:

- 2001 Spring Break, lightning caused shutdown
- People stranded on lift
- Loss over \$2 M revenue

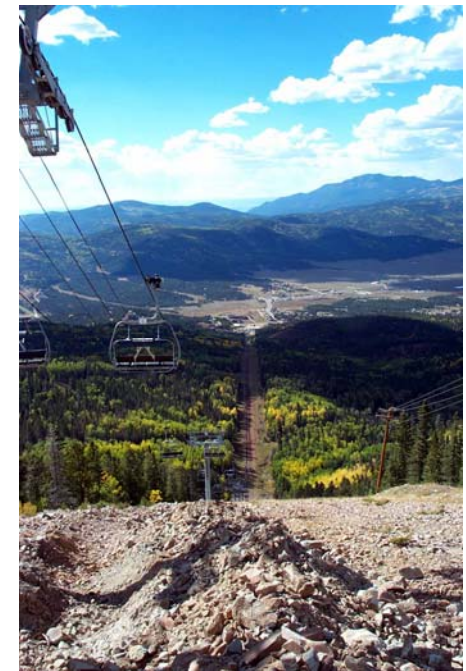

Base Station

Lift is computer controlled
Base control house
Similar control at top



Only Ground Between Towers

Grounding for communications cable



Terminus of messenger wire (only grounding between towers)

System Was Not Integrated

- Ground *system*
- Rod at each tower
- 2 miles of 2/0, each tower connected
- Rings at top and bottom stations
- No outages since!



Exothermic Welding

- Grounding connections should be exothermic welded.



Lower Base Station

Soaking bentonite with water



Angel Fire Result

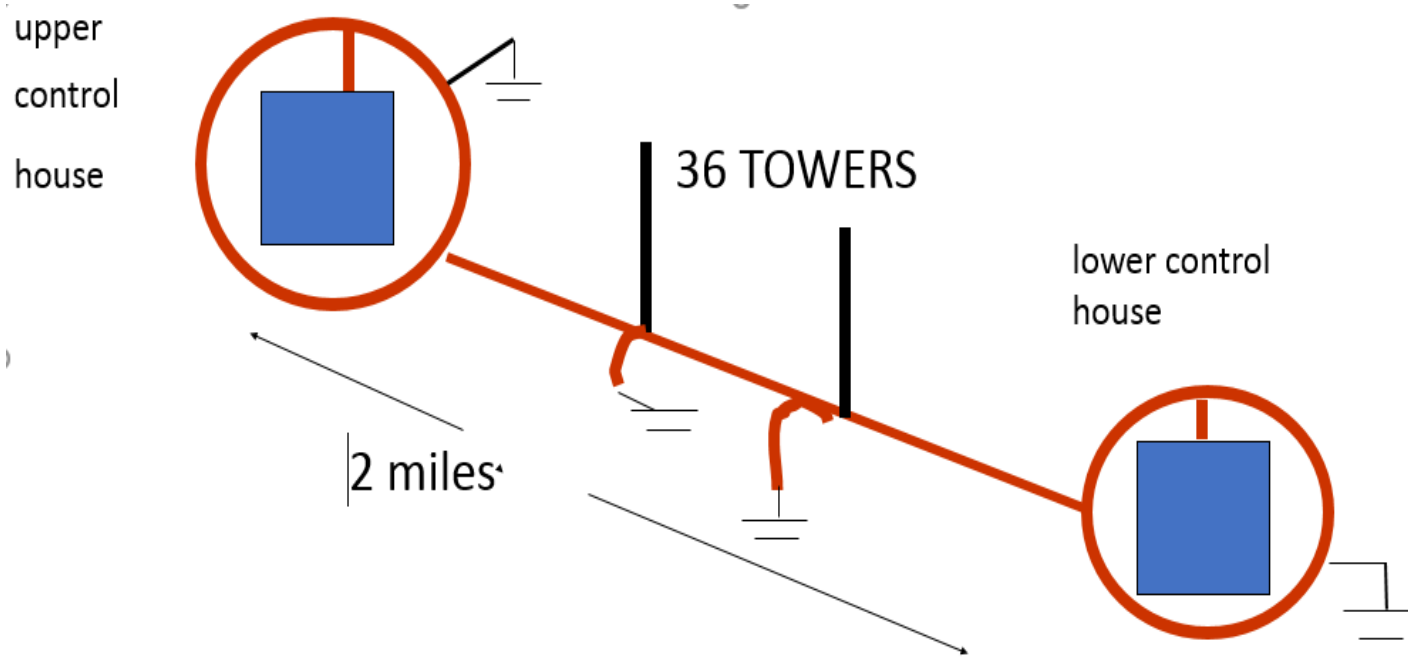

What Not To Do

- Mixed Connectors

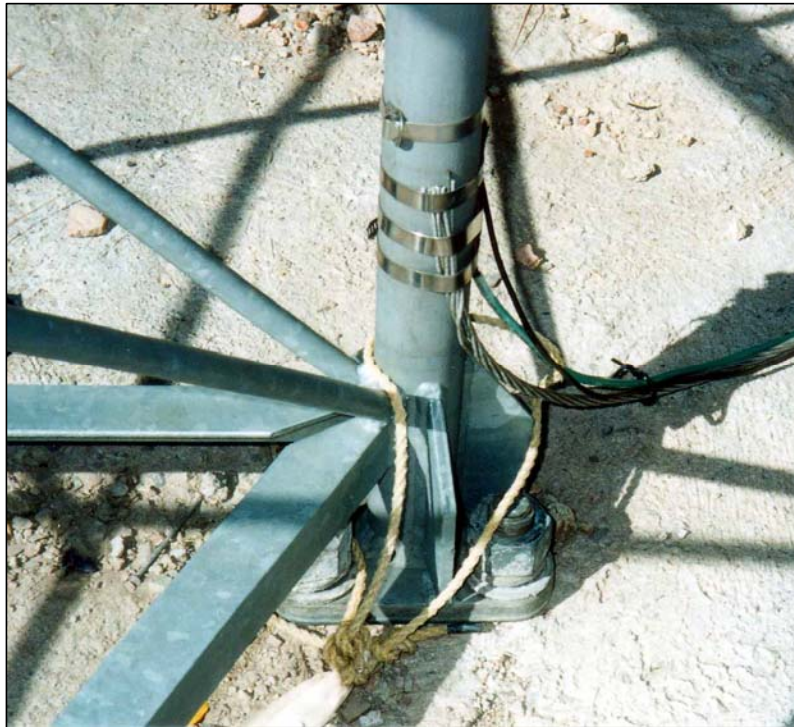

Connection to Electrode



Connection to Water Service



Seed Development Example

You probably don't think of vegetables as "sensitive" equipment



Greenhouses Must Be Cooled



Seeds Must Be Watered and Fertilized



Has Emergency Generator But Poor Grounding

- SPDs on Service and feeders
- Original 1 ground rod $>150 \Omega$
- Installed 3 new 24 ft. electrodes
 $\approx 4 \Omega$ result
- \$25-30K per event avoided



Multi Building Campus Examples

Verestar

Largest satellite facility in North America



Verestar Control Room

6 buildings

Over 100 acres



Dishes Are Remote

42 satellite dishes

3.5 m to 30 m



Verestar Multi-structure Layout

One
Grounding
System

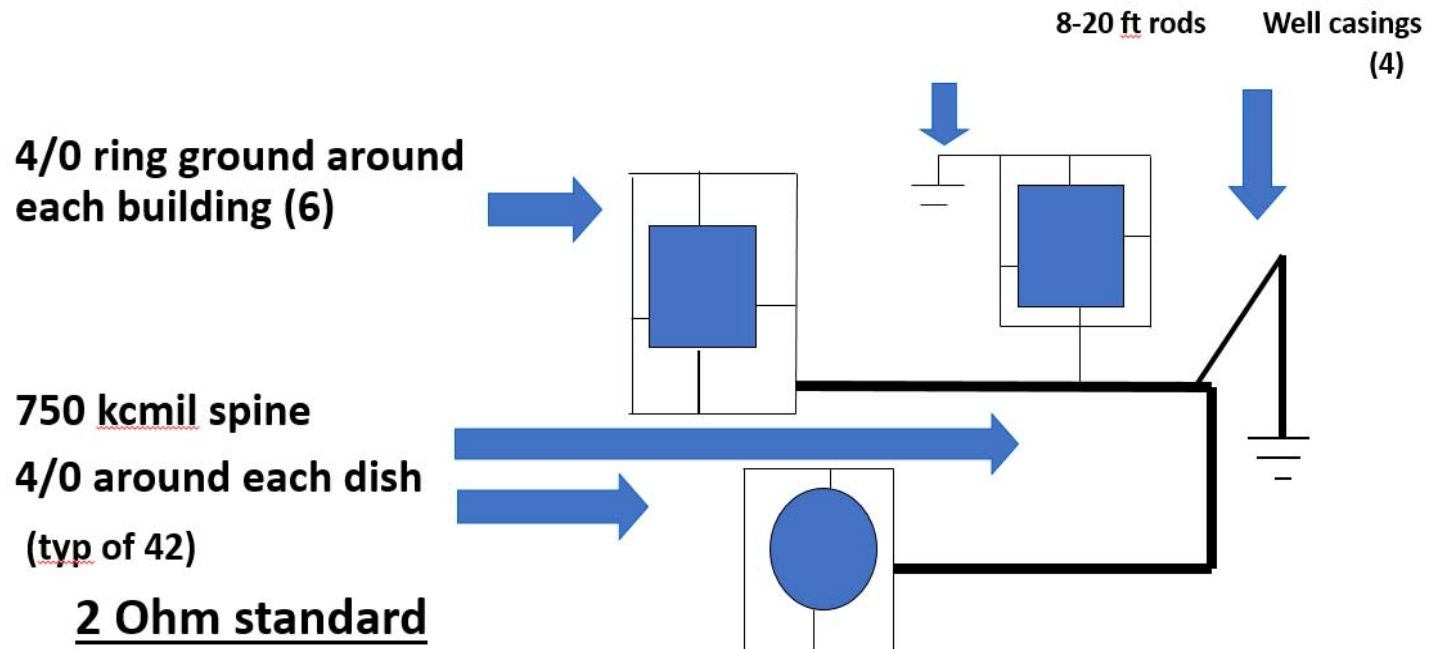

M.I.T. Case Study

Current Interior Design Standards:

Separate computer feeders, panels, and branch circuits

4 outlets per 20 amp. Branch circuit



Multi-building Campus

- 500 kcmil ground ring
- 1000 kcmil “spine”
- Triangulated electrodes at each corner

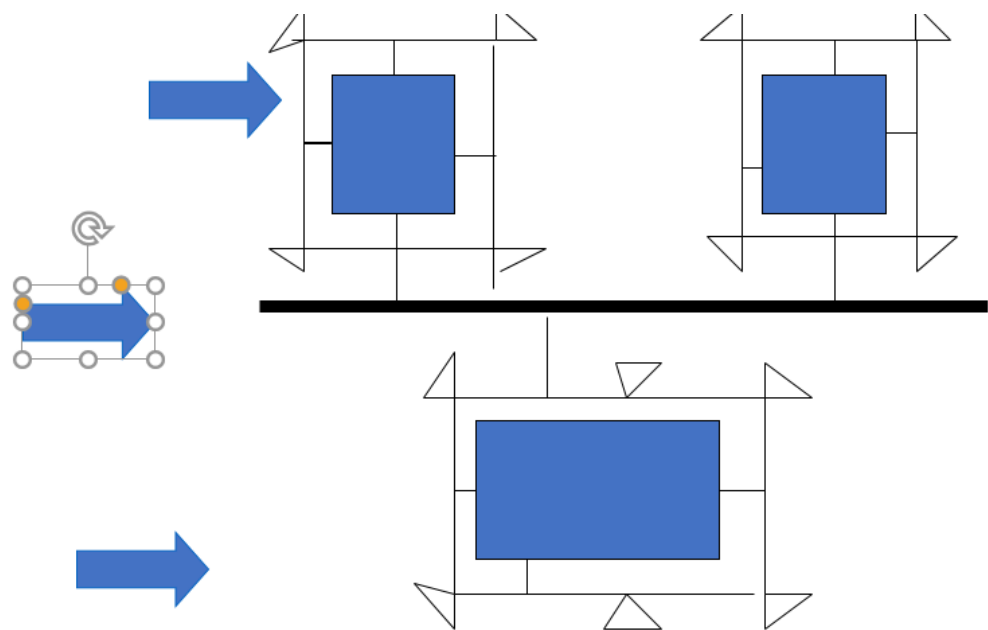

Separate Systems

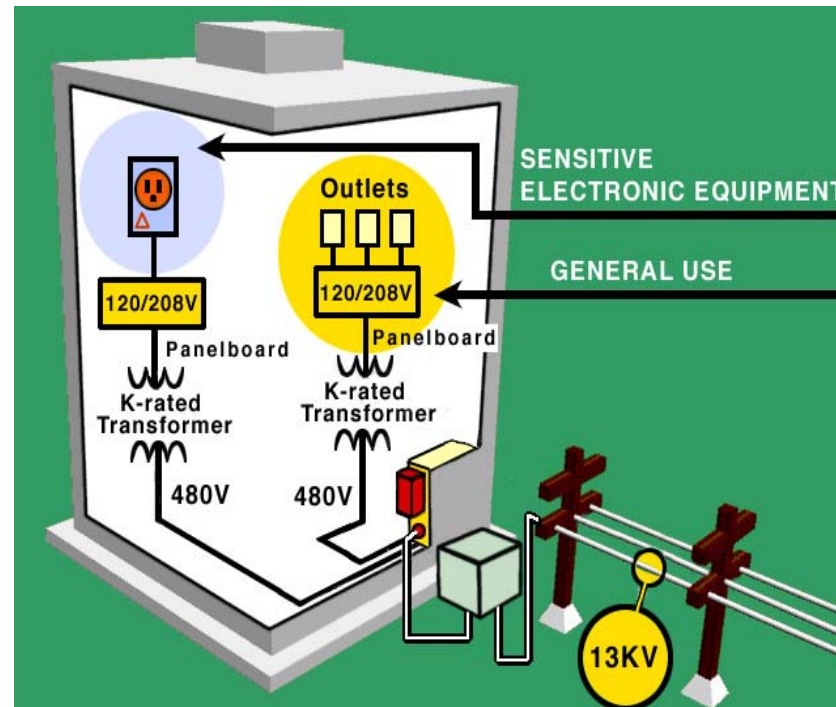

M.I.T. Design Standards

Current Design Standards:

- 10 ohms or less grounding resistance (economic reasons)
- Double (and sometimes triple) neutrals
- K-rated transformers
- Always a separate grounding conductor
- Always copper

Costs

- Cost of materials is CHEAP compared to labor, equipment, downtime
- Cost for all PQ improvements:
 - Adds about 1 to 1-1/2% to the overall cost of construction, but....
- “Never have to revisit infrastructure for foreseeable future”

Former MIT Chief Engineer

“Clean” Grounds vs. Isolated Grounds

The Earth Cannot Be Used as a Conductor

Earth is never a satisfactory conductor

NEC, Art. 100 pre-2020 used to say:

Effective Ground-Fault Current Path. An **intentionally constructed, low-impedance electrically conductive** path designed and intended to carry current under ground-fault conditions from the point of a ground fault on a wiring system to the electrical supply source and that facilitates the operation of the overcurrent protective device or ground-fault detectors.

2020 NEC is Different

- New definition of *Ground Fault Current Path*: An electrically conductive path from the point of a ground fault on a wiring system through normally non-current-carrying conductors, grounded conductors, equipment, or the earth to the electrical supply source.
- Earth itself (and other questionable materials) can be a current path, HOWEVER,
- DO NOT BE FOOLED. THIS IS POOR PRACTICE. Art. 250-118 lists acceptable types of equipment grounding conductors.

Case Study: “Clean Grounds”

McAfee Tool and Die



Machine Shop is a High-Tech Environment



Every CNC Machine is Computer-driven



Comm Cable Was Unintentional Antenna

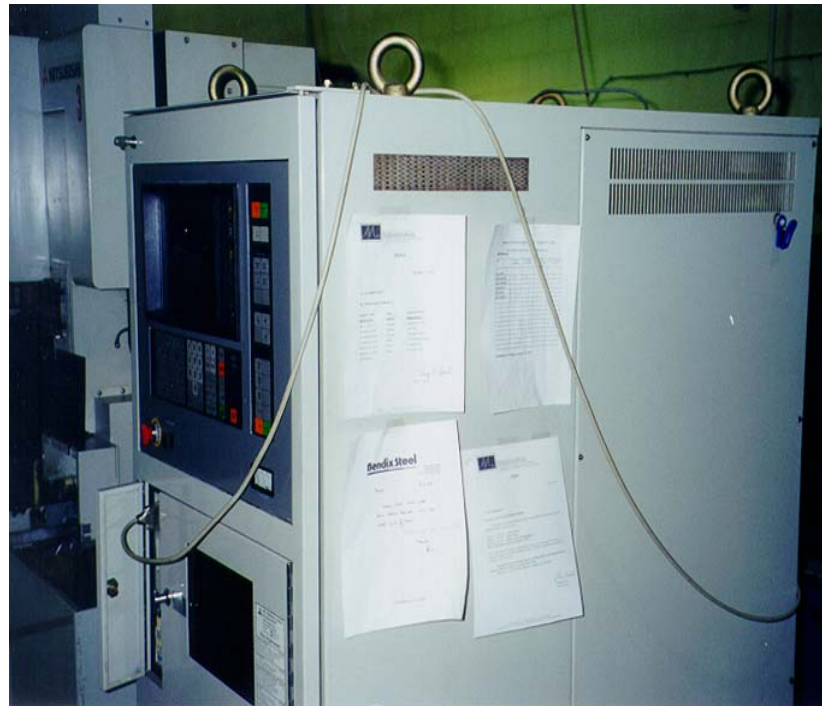

So-called “Clean Grounds”

“Supplemental”
electrodes abandoned

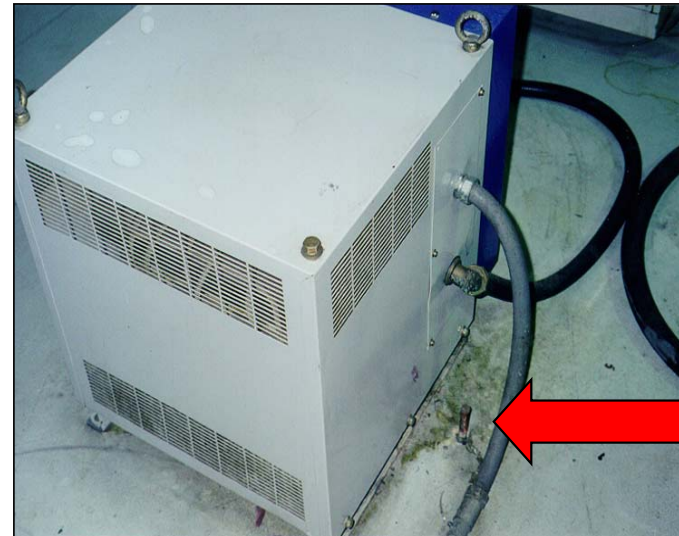
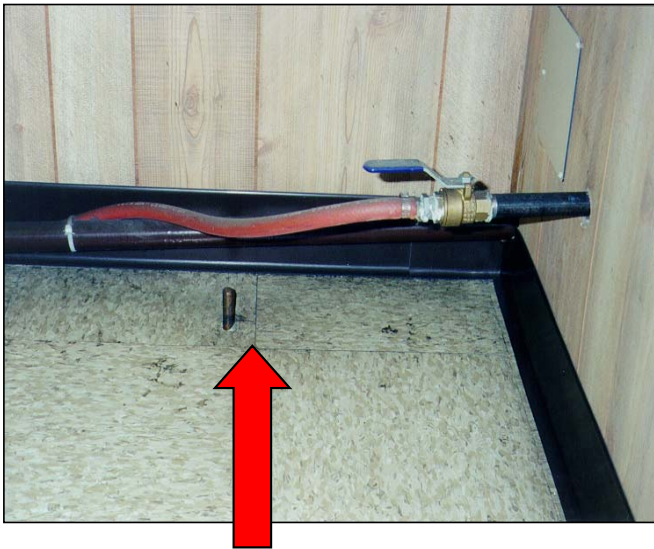

McAfee Layout

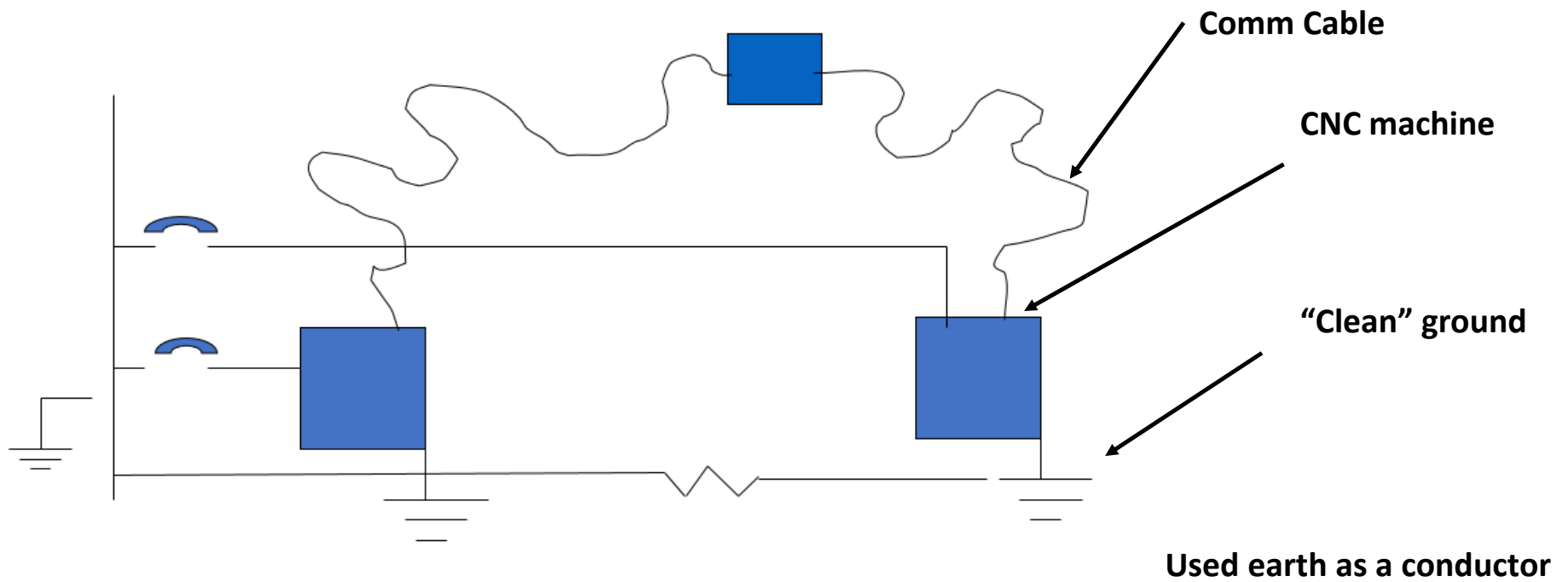

Earth is Not Permitted as a Grounding Conductor

**No separate grounds allowed
only one grounding system**

- **250.54** ...the earth shall not be used as an effective ground-fault current path...

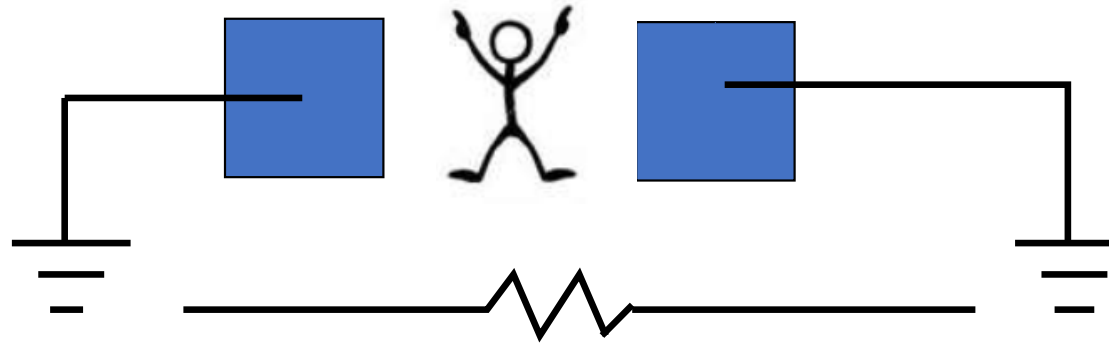

McAfee Results

- All “clean” grounds were removed
- Connection to earth was supplemented with 3-20 ft ground rods in a triangle pattern. +/- 5 Ω
- Comm cable re-routed
- After 7 years of outages and service calls, all problems disappeared

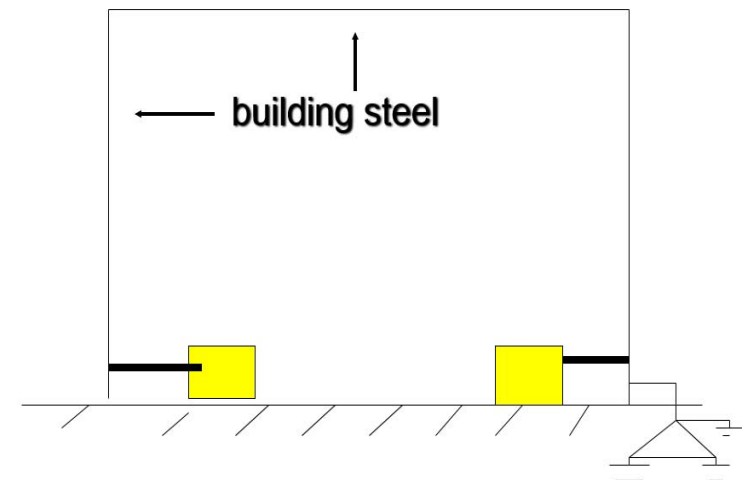

What Is an IG?

So if “separate” grounds are a no-no,
what is an isolated (“insulated”) ground?

Let's Take a Break

10 minutes only, please.

Insulated Grounding

Insulated Grounding (IG)

Good idea to install in new circuits

Gives flexibility to use or not

This is NOT IG



What is an Isolated Ground Circuit?

IG circuits are recommended for all circuits serving sensitive loads

- Characteristics:
 - Totally separate conductors
 - Totally separate neutral
 - Totally separate ground
 - Totally separate conduit

All the way back to the service

Isolated (Insulated) Grounding

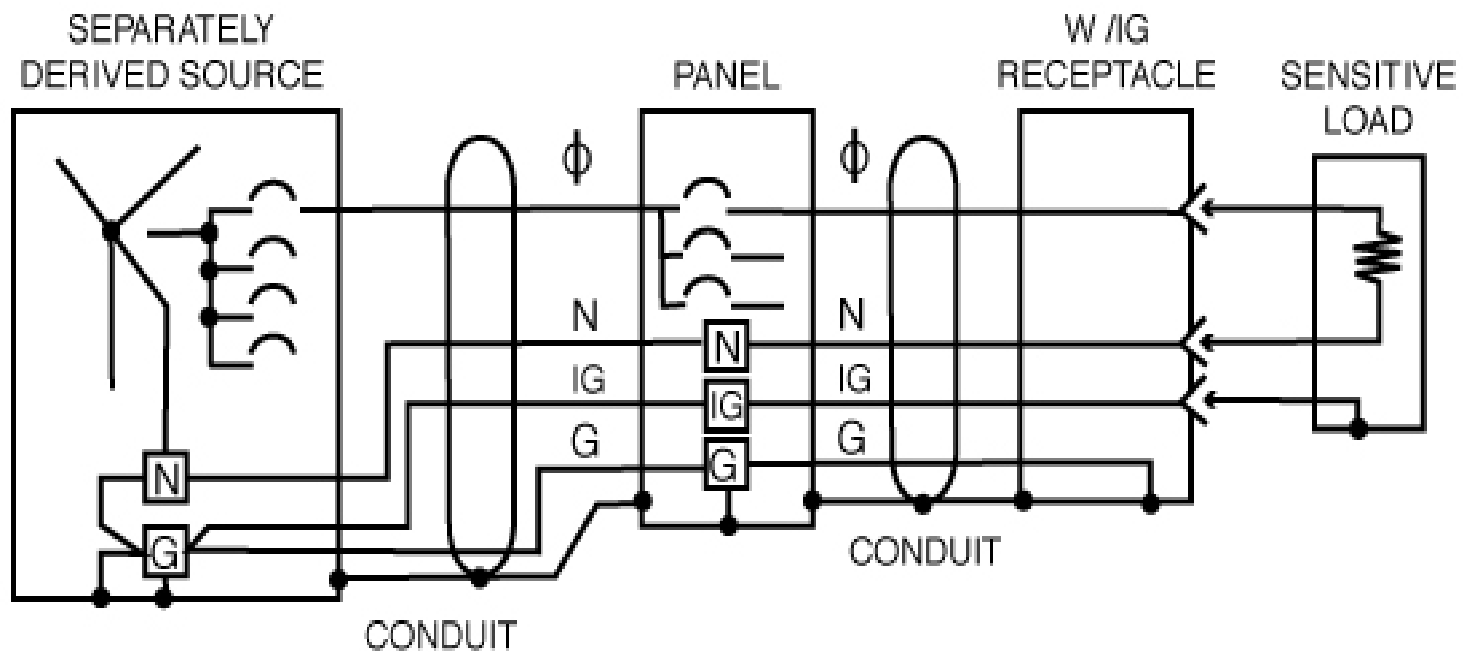

IG Circuit with Separately-Derived System

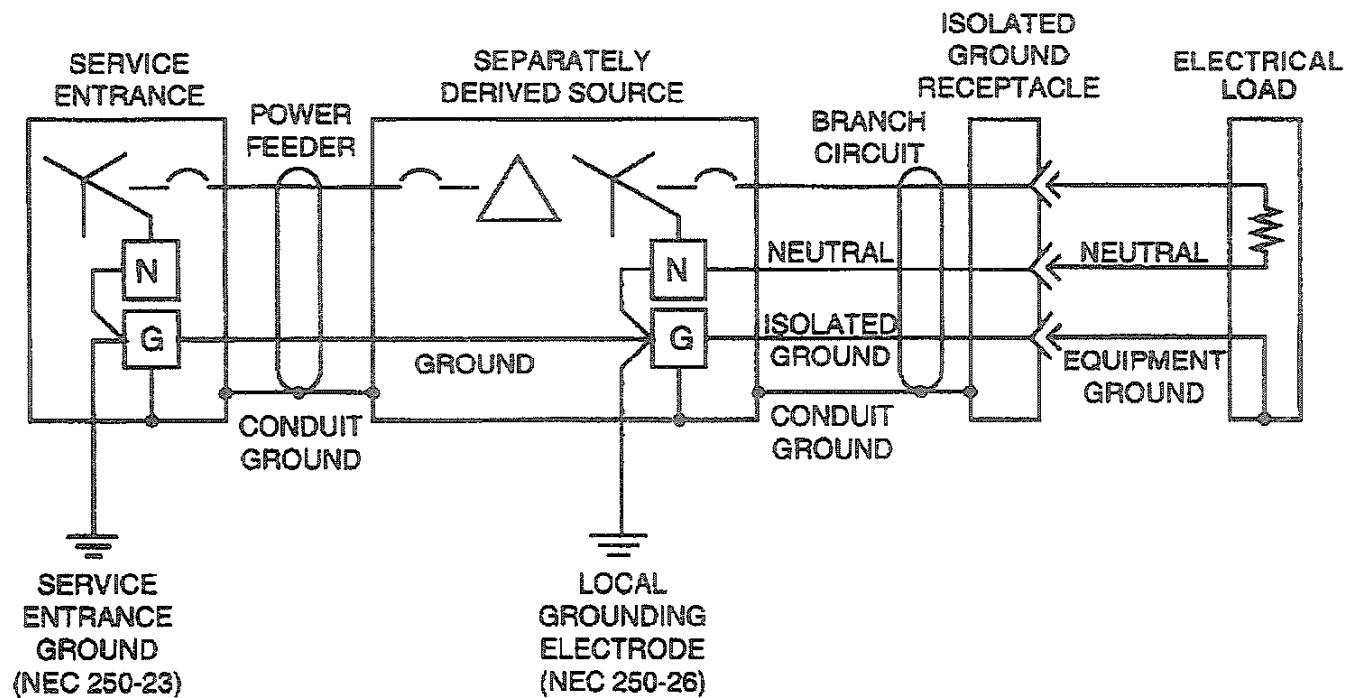

Isolated Grounding

Good idea to use an IG circuit for all critical loads.
Carry the IG ground all the way back to the service point.

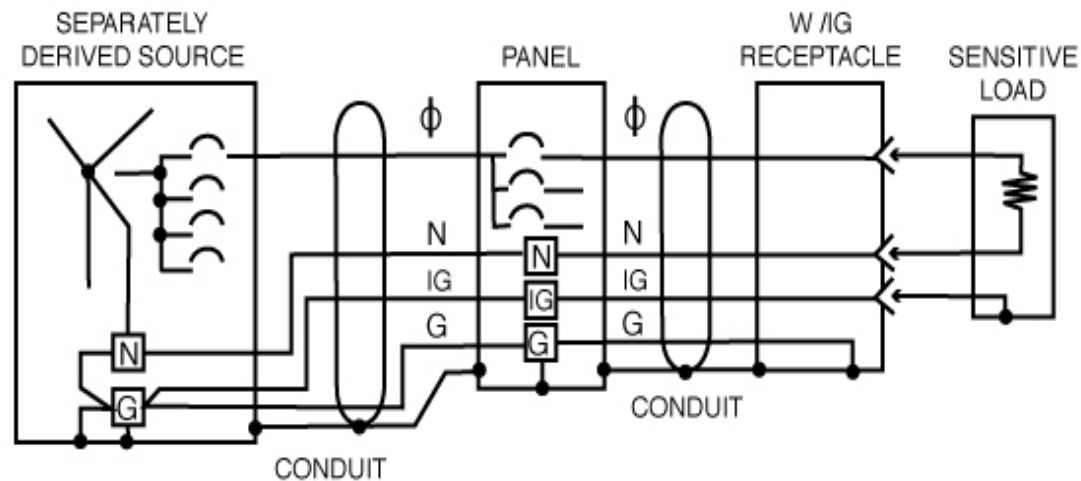

IG Not Connected to Cabinet

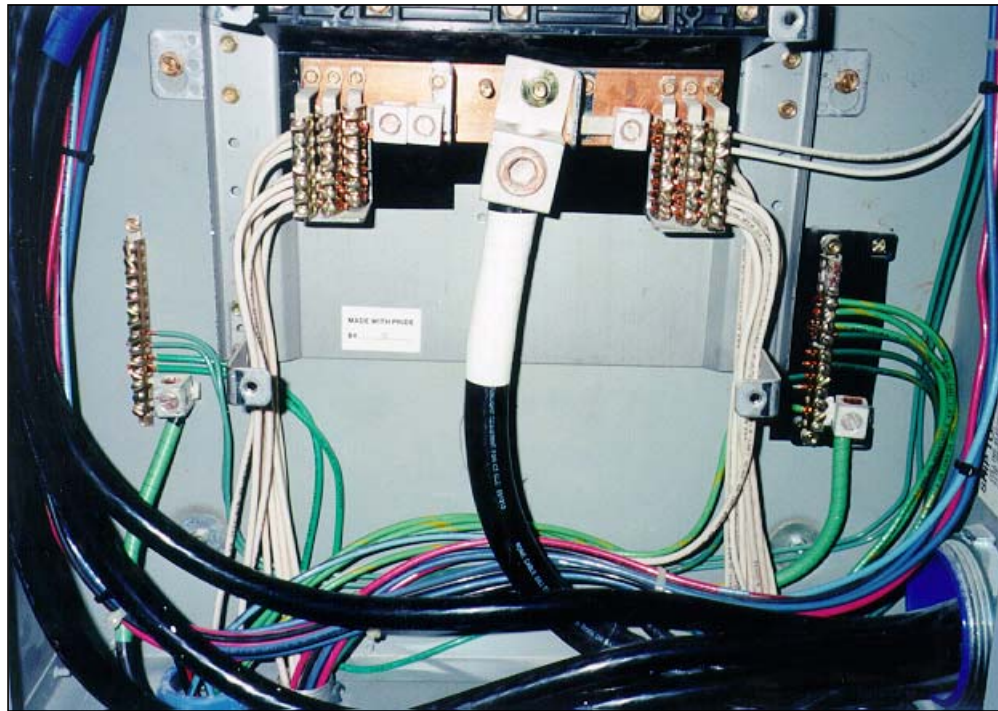

Receptacles

IG or SG?

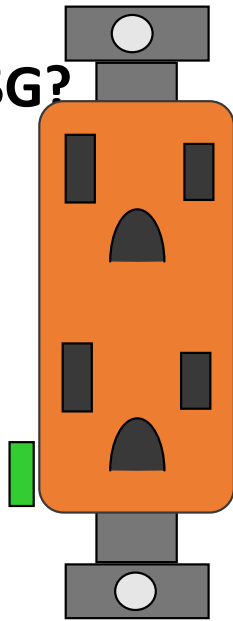

IG

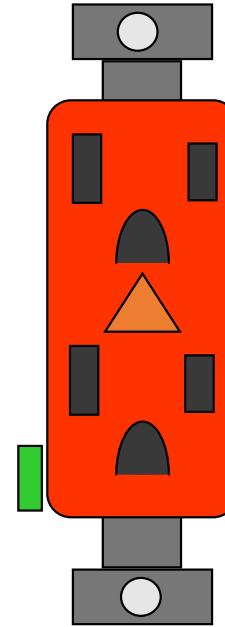

Either receptacle
may be any
color under the
most recent
NEC editions.

Receptacles

Do you see the difference?

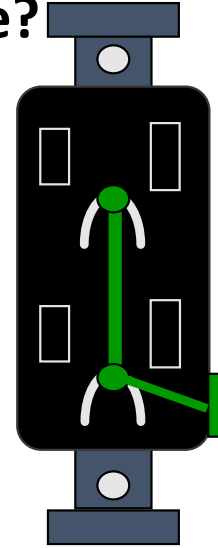
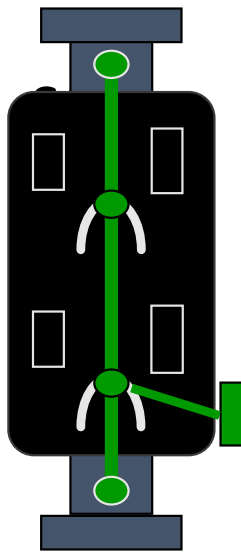

Receptacles

IG or SG?

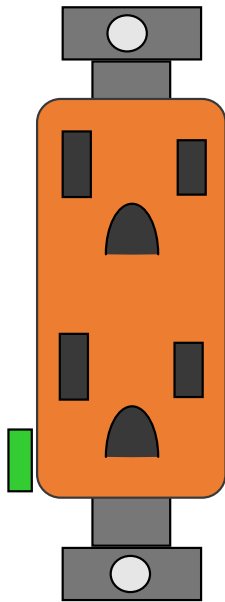

IG

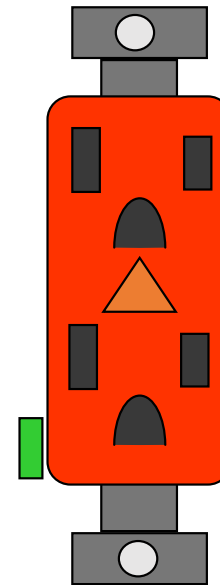

An orange color delta

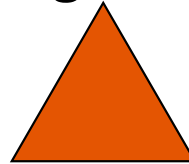

is required to be
embossed on the face

Why Use IG?

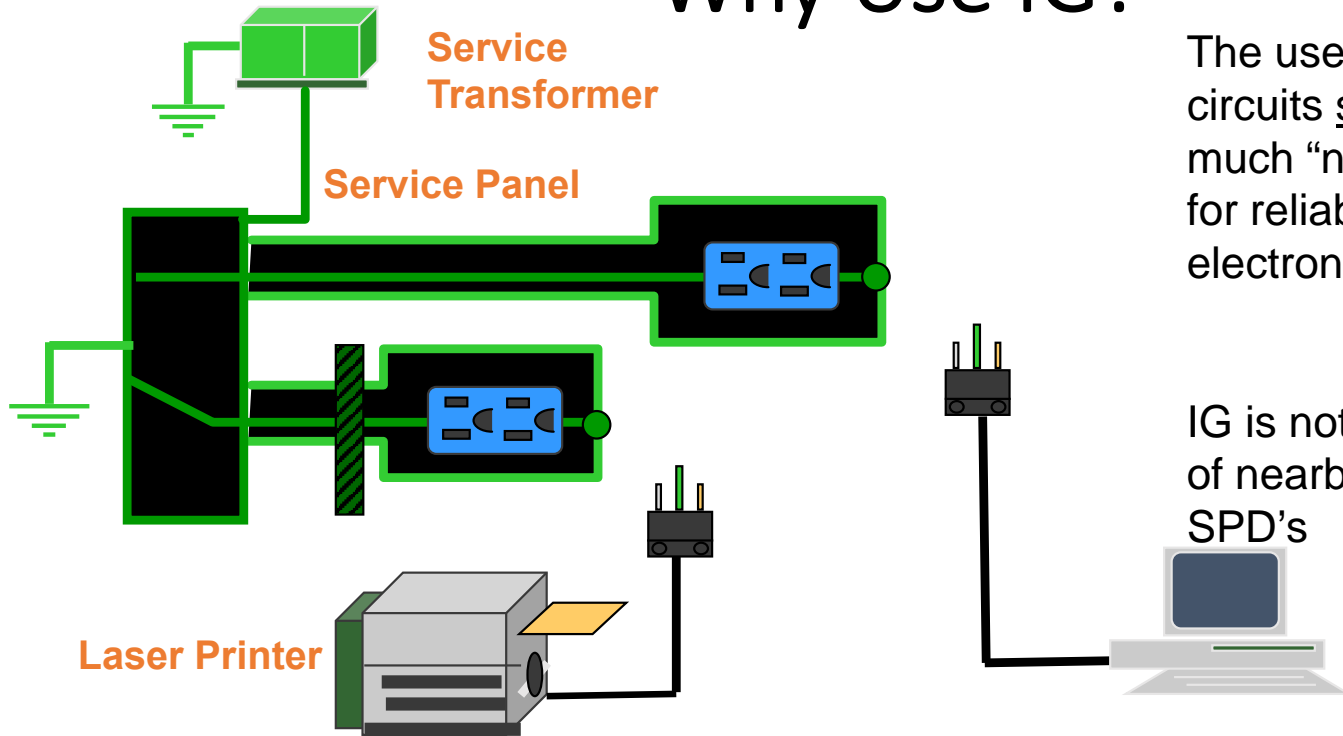

The use of solidly grounded branch circuits sometimes results in too much “noise” on the branch circuit for reliable operation of the electronic loads.

IG is not subject to induced energy of nearby lightning, thus smaller SPD's

When You Are Involved

- When your equipment is involved, you should be the expert when you walk on site.
- You are responsible to be sure all is right if not, you fix it.
- If you don't have the expertise to "fix", get an expert involved. The key: dazzle with brilliance not baffle with BS.
- Learn how to recognize issues that will impact the proper installation of your equipment and its sustainability.
- Inform your customer (or boss) of the conditions that can impact your installed equipment.
- Some will "ignore" and hope issues go away. Put it in writing, inform and then it is their responsibility. Their choice.

When You Are Not 100% Sure

- Develop a relationship with a someone that has the expertise to assist your efforts.
- Do not guess, hope or assume you are right.
- Learn from them, develop your own expertise.
- Avoid those that are just out to sell something.

Grounding & Bonding

- Grounding (Earthing) is the foundation of the electrical system.
- Bonding is the “rebar” that holds the foundation together.
- The electrical system is not safe or sustainable unless the grounding & bonding are completed to the highest possible standard.
- Anything built upon a flawed foundation will never be proper or sustainable regardless of the effort with which it is built.

What's Next

- Understand what makes up soil resistivity.
- Know the variables in grounding conditions.
- Understand the different types of grounds.
- Understanding ground testing.
- Ground Augmentation—What works & or will not.

What's Next

- Ground Loops – Learn how to avoid them.
- Why grounding & bonding are critical for SPD.
- SPD – What you need to know about SPD.
- SPD – Your role in making sure they work.

But First

Examples of very poor workmanship

Who is responsible?

Multiple Errors in One Place



- Two Wires under the same lug.
- Improper lug for the wire size.
- Screwed, not bolted.
- Connected to painted steel.
- No conductive grease.
- Steel not continuous or contiguous.

Phone System as Installed by Carrier

Grounding bar not connected to anything. This is a life safety issue as well as a formula for equipment damage.



Missing Ground

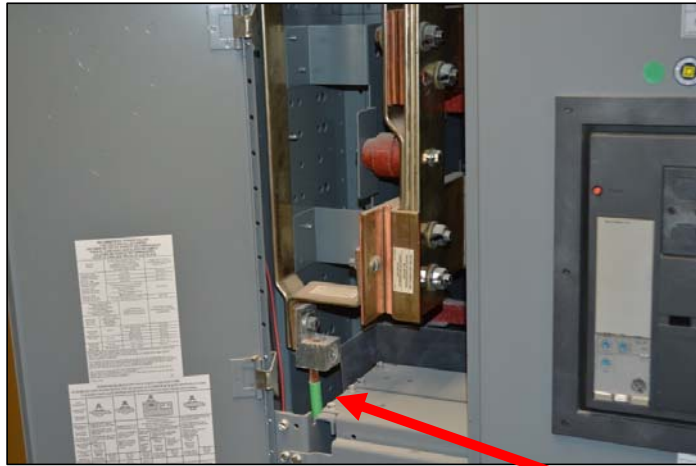

MS1's Bond is shown to the left, MS2's Bond is show above...(missing).

THIS PASSED INSPECTION

State Office Building

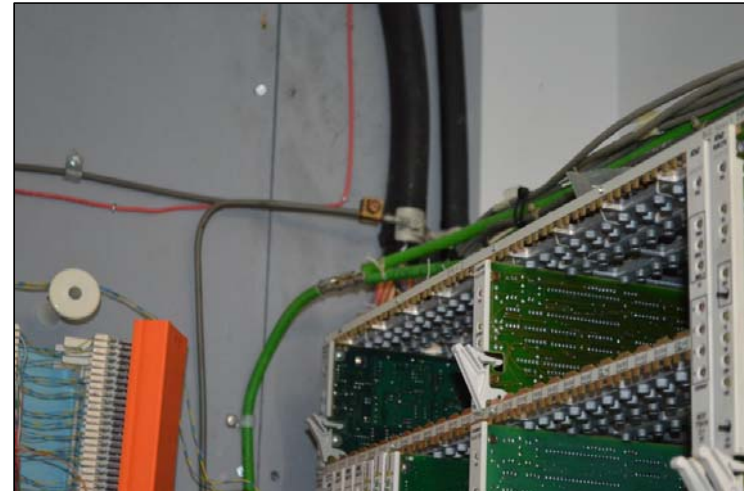
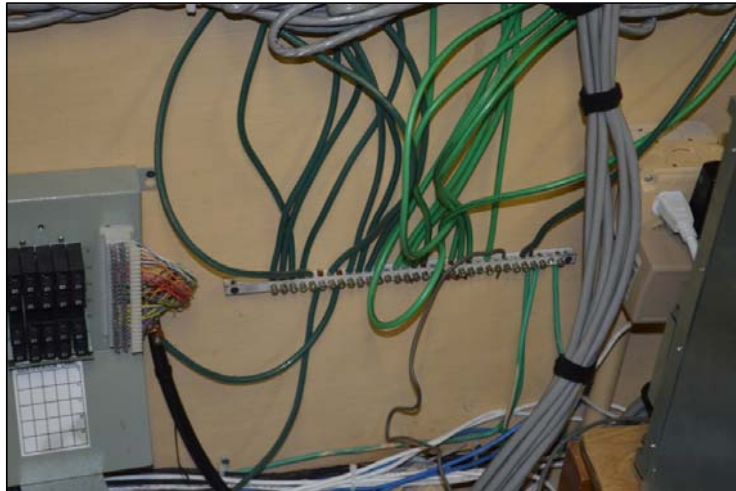

This phone system is so unreliable the owner kept a box full of replacement cards as they failed all the time. Annual cost? Over \$100,000. After the FIX, no damage in years.

Another State Office Building



500,000 sq. ft. office building computer Room

The computer person said he wanted to make sure the critical equipment was grounded properly so he had additional ground rods, ground bonding bars added.

Tape Holding the Ground Bonding?



This Was At a 9-1-1 Center



Very Expensive Copper Theft!



What is the Resistance?



Bonding to Building Steel

The code allows it, but in a lightning prone environment this is trouble!



What is Wrong Here?



What Should be Done Here?



Ground Rod Inspection Box



- Suggested at each electrode site

Suggested Ground Ring Test Well

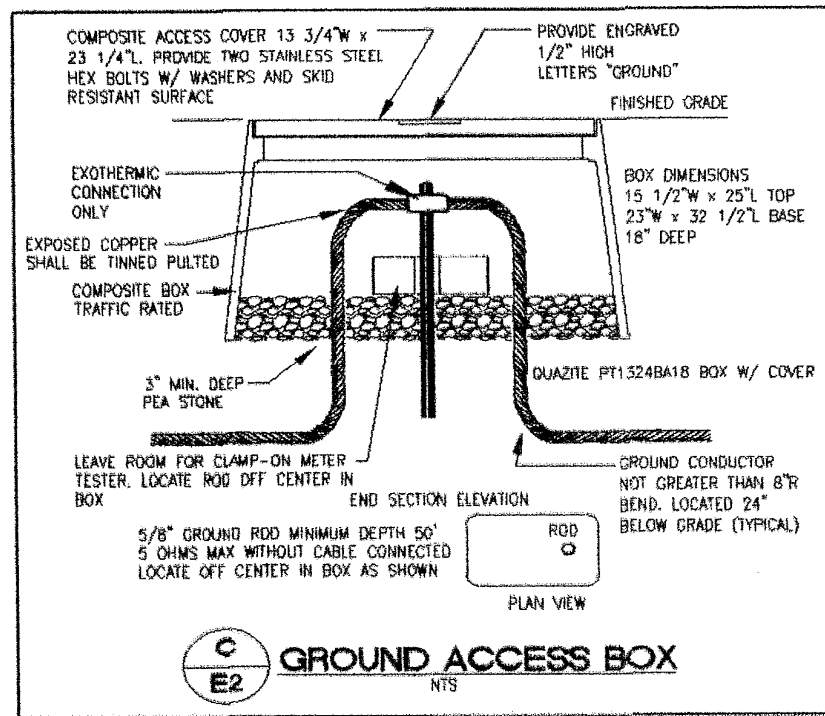

Ufer Ground Has Limitations

What is a Ufer ground?

What happens when a Ufer ground is hit by lightning?

KPTH & KMEG-TV



What Can Happen to a Ufer Ground?

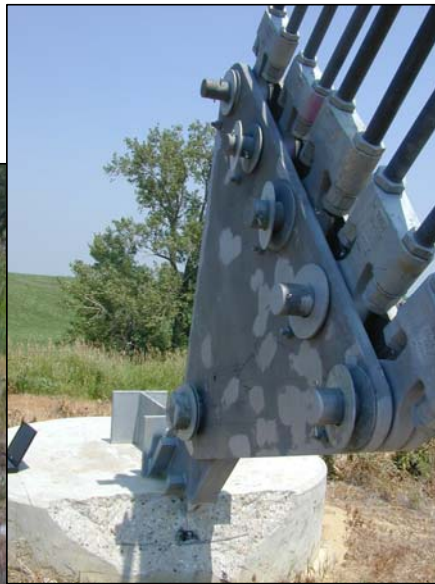

The Reason for the Damage

Burn scar is evidence that lightning found a vertical reinforcing rod (center), which likely acted as an efficient Ufer ground, offering lower resistance than that of the installed grounding/lightning protection system.



The Fix

Deep electrodes up to
65 ft

Stainless steel because of
acids in earth

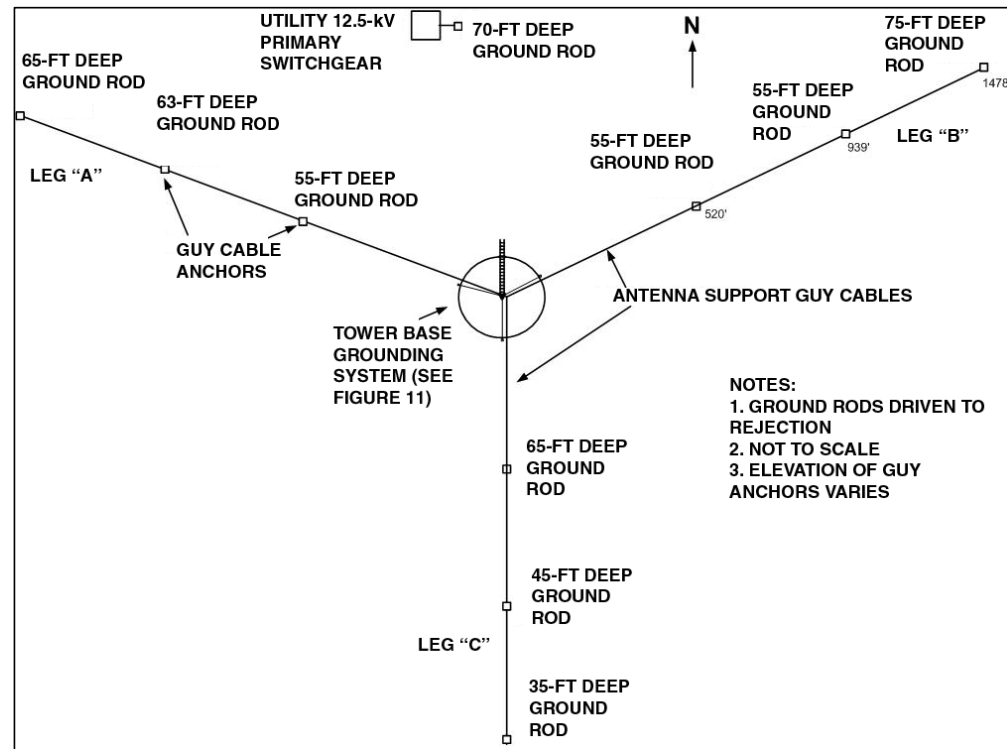

Testing Ground Systems Performance

- NEC 250 Grounding Performance Requirements.
None!
- NFPA 780 Grounding Performance Requirements.
None!
- UL96A Grounding Performance Requirements.
None!
- IEEE Grounding Recommendations.
5-Ohms or less.

5 – Ohm Grounding

- Should be the requirement for the ground rod system of every electrical system.
- Ufer grounding & bonding is in addition to the 5-Ohm ground rod system.
- The maximum resistance of a lightning protection system ground rod should be 5-Ohms.
- All this added together, properly bonded will assure the odds of damage to the facility is VERY slim.
- Add to this a properly designed and installed surge protection system and the probability of any damage comes close to “0”.

Why These Factors Are Important

- $I = E/R$ Ohm's Law
- Current is what causes the damage
- The most current will flow when R is minimal (in the ground system)
- So you can have all the voltage you can imagine and if the "R" of the intended path is close to "0" you have "0" damage inside.

Soil Resistivity

To determine the resistivity of the soil, use the Wenner four-point measurement method, it corresponds to IEEE Std. 81.

The Wenner 4-point measurement test employs 4 test probes, spaced apart from each other at equal distances (the distance is critical).

Wenner Method

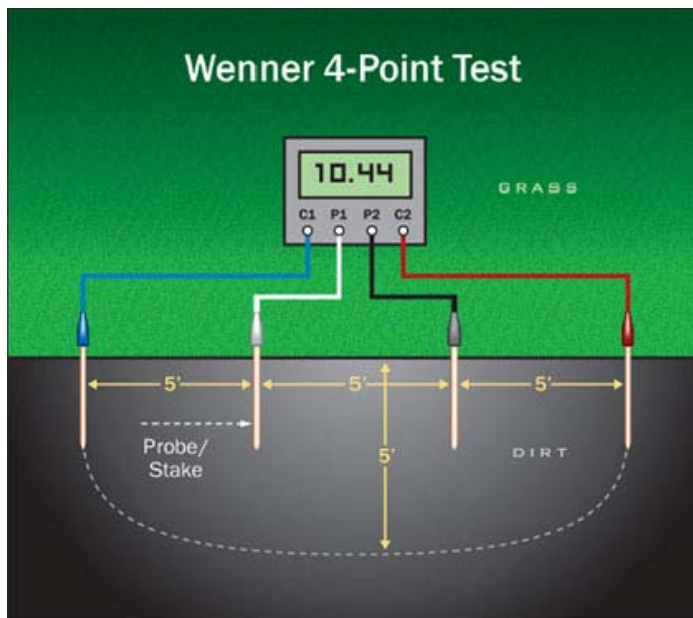

Wenner method is commonly used to measure ground resistivity

Distance between probes is 5-10 ft.

Long Form Wenner Formula

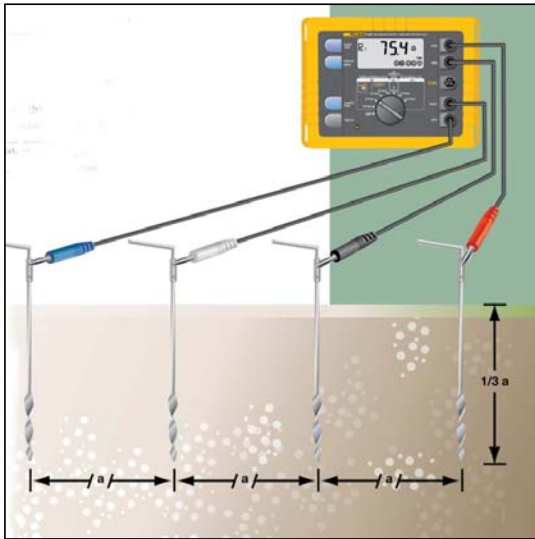

- Four Point Soil Resistivity Test layout.

- ρ_E = measured apparent soil resistivity (Ωm)
- a = electrode spacing (m)
- b = depth of the electrodes (m)
- R_W = Wenner resistance measured as "V/I" in Figure (Ω) if b is small compared to a , as is the case of probes penetrating the ground only for a short distance.

$$\rho_E = \frac{4 \cdot \pi \cdot a \cdot R_W}{1 + \frac{2 \cdot a}{\sqrt{a^2 + 4 \cdot b^2}} - \frac{a}{\sqrt{a^2 + b^2}}}$$

Simplified Wenner Method

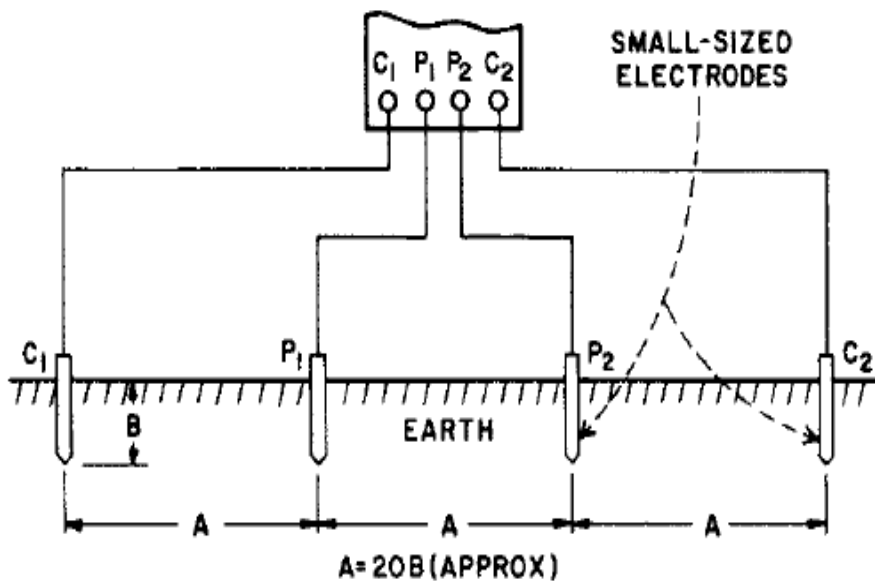

$$\rho = 2\pi A R$$

Where ρ = avg. soil resistivity

A = distance between electrodes
(2 – 30 m)

B = depth of probes $\leq 1/20 A$

R = earth resistance in ohms

The Factors That Impact Soil Resistivity

- Electrolytes which consist of moisture, minerals and dissolved salts.
- Dry soil (soil that does not retain water) has high resistivity
(Florida “Sugar Sand”)
- The highest resistance “normal” soil conditions are: Gravel, Sand & Stones with little or no clay and/or loam.
- Soil that holds moisture is low resistivity.

Resistivity of Soil Types

Chart is Influenced by Temperature and Moisture

Resistivity (approx.), ohm-cm			
Soil	Min.	Average	Max.
Ashes, cinders, brine.waste	590	2,370	7,000
Clay, shale, gumbo or loam	340	4,060	16,300
Same, with varying proportions of sand & gravel	1,020	15,800	135,000
Gravel, sand, stones with little clay or loam	59,000	94,000	458,000

Soil Dictates Depth Required

SOIL RESISTIVITY	LENGTH FOR A 5-Ohm GROUND	LENGTH FOR A 10-Ohm GROUND
50 Ω-M	33 Feet	9.8 Feet
70 Ω -M	52.5 Feet	20 Feet
100 Ω -M	85 Feet	33 Feet
150 Ω -M	145 Feet	59 Feet
200 Ω -M	207 Feet	85 Feet
300 Ω-M	344 Feet	144 Feet
500 Ω -M	636 Feet	276 Feet
1000 Ω -M	1444 Feet	636 Feet

Temperature vs. Resistivity

<u>Temperature</u>		<u>Resistivity</u>
<u>C</u>	<u>F</u>	<u>Ohm-cm</u>
20	68	7200
10	50	9900
0	32 (water)	13,800
0	32 (Ice)	30,000
-5	23 (Ice)	79,000
-15	14 (Ice)	330,000

*As temperature varies throughout the seasons therefore soil resistivity will also vary with the moisture content and the temperature. This is one of the reasons deep earth grounding is preferred in areas where the “frost line” is deep. A 10’ ground rod in some areas does not provide a ground in all seasons.

Resistivity of Various Waters

Classified Water	$\Omega - m$
Pure Water	200,000
Distilled Water	50,000
Rain Water	200
Tap Water	70
Well Water	20~70
Mixture of River & Sea Water	2
Sea Water (Inshore)	0.3
Sea Water (Ocean 3%)	0.2~0.25
Sea Water (Ocean 5%)	0.15

Table 9 : Resistivity of Water(Approx.Value)

3-point Fall of Potential Test

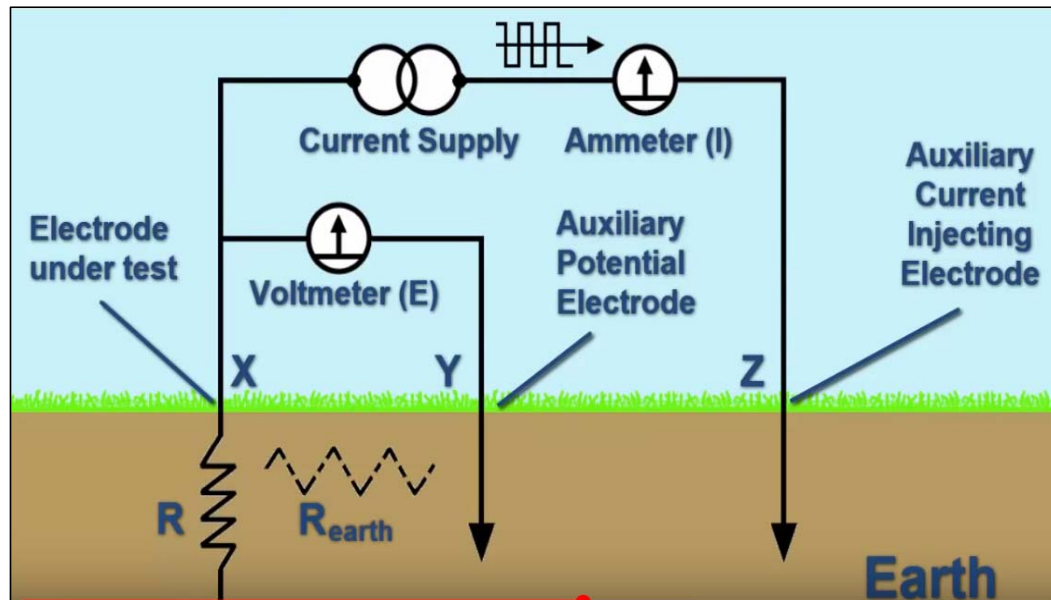

Used to measure resistance of an electrode

Ground Rod Fall of Potential Testing & Concentric Shells of Earth

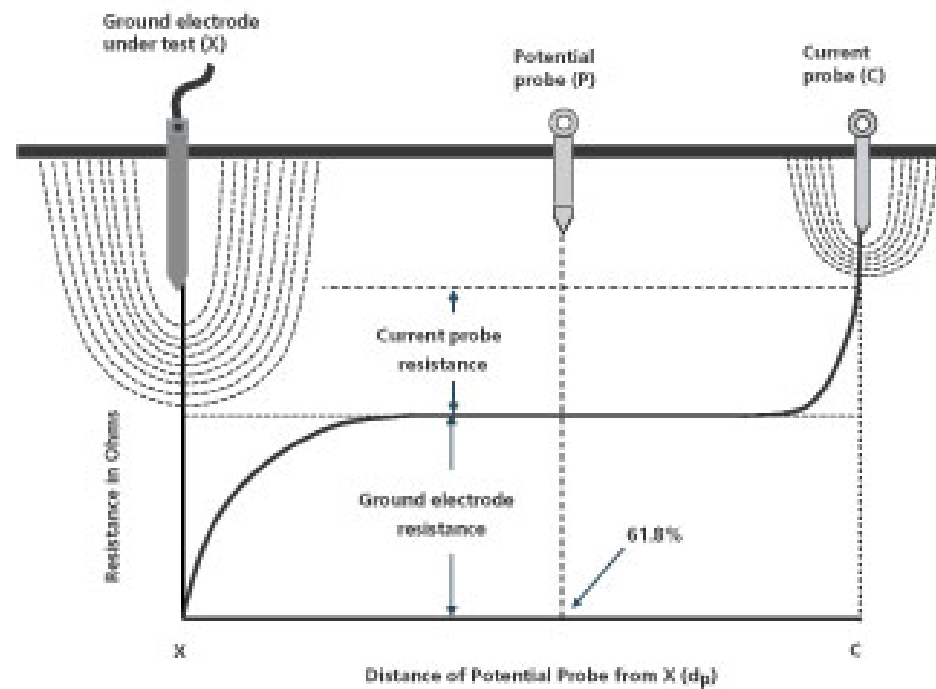

Rods Too Close Overlap

- 2 rods 100 Ω each
too close DOES NOT EQUAL
50 Ω

“Adding a second rod does not provide total resistance of half that of a single rod, unless the two are several rod lengths apart.”

IEEE Green Book

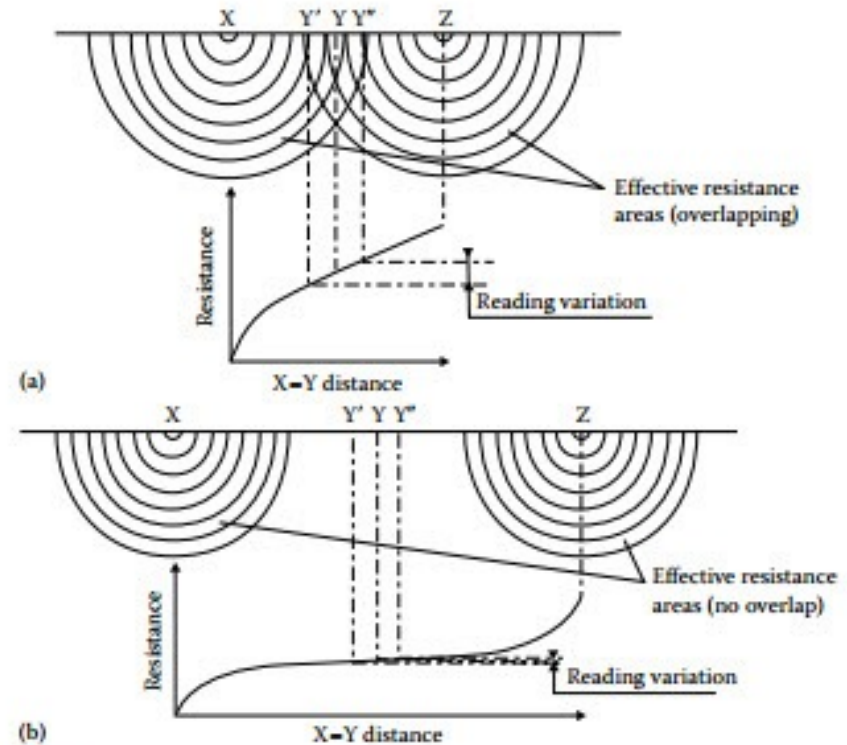

FIGURE 11.17 Effective resistance areas (cylinders of earth) (a) overlapping and (b) not overlapping.

Distance in Feet to the Auxiliary Electrodes Using the 62% Method**

<u>Depth Driven</u>	<u>Distance to "Y"</u>	<u>Distance to "Z"</u>
6 ft	45 ft	72 ft
8	50	80
10	55	88
12	60	96
18	71	115
20	74	120
30	86	140

** The above is for "average" conductive soil with a 5% moisture content. The distances will triple if the soil has 10% moisture content and increase 12 times if the soil has 20% moisture content.

Band of Error

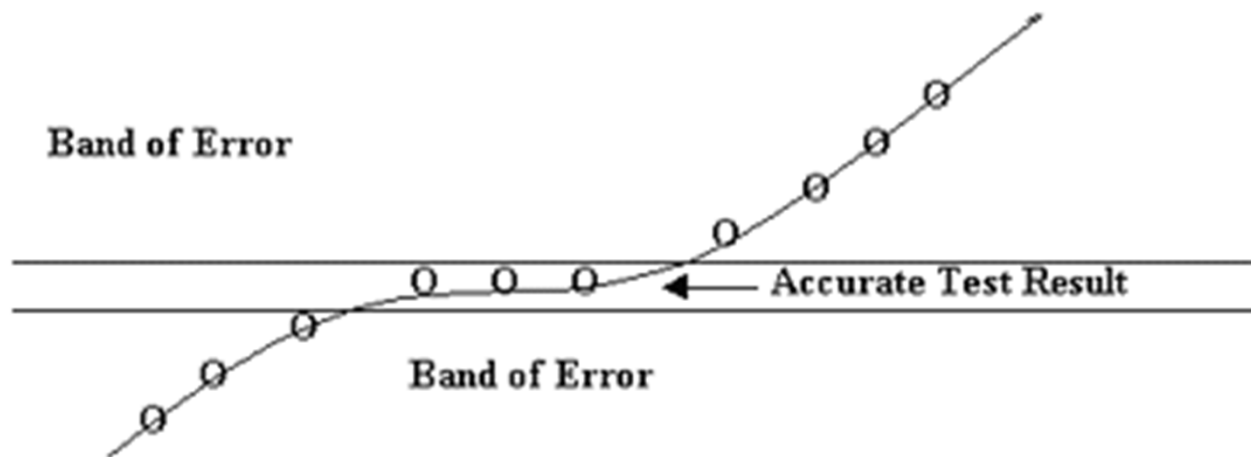

Depth of Rod

Depth has significant effect

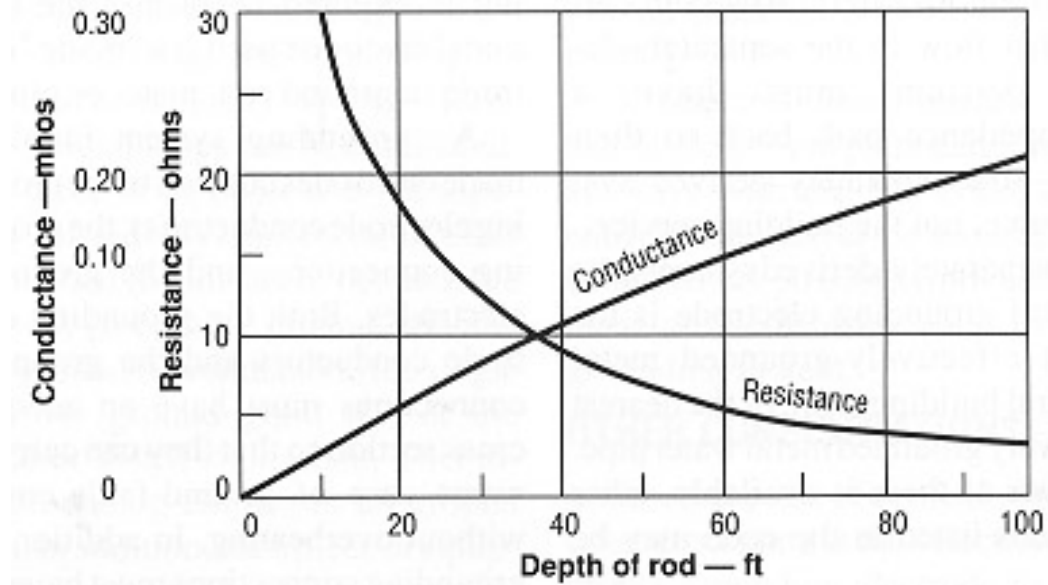

Diameter of Rod

Diameter has little effect

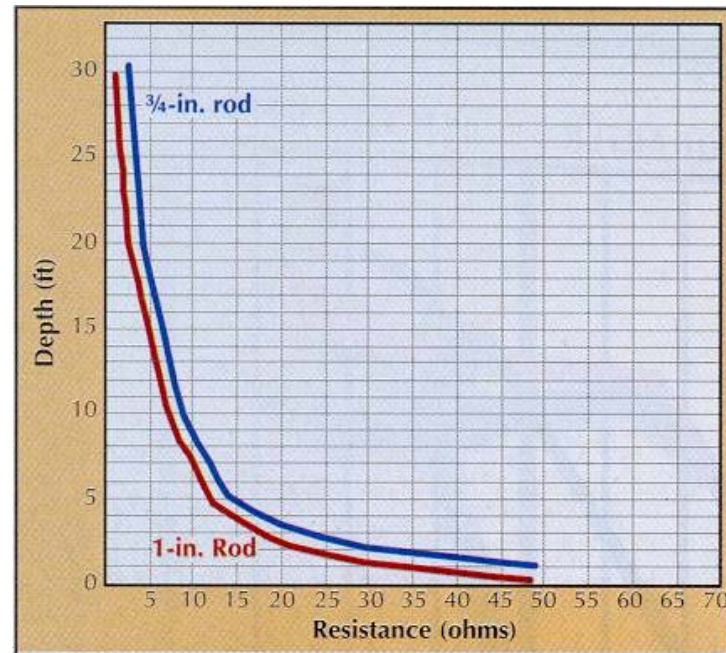

Ground Rod Resistance & Rod Size

- Increasing the diameter of the ground rod does little to reduce the resistance to earth.

Doubling the diameter reduces the resistance by less than 10%.

The only logical reason for a larger rod is the soil conditions (aka: Conditions require a $\frac{3}{4}$ " or larger ground rod so the rod can be installed. It is not unusual to have to "drill rock" or other hard earth structure.

Annual Ground Testing

- The technician that completes ground testing must have been trained by the factory or their approved training representative.
- The technician **MUST** be certified to complete the testing.
- It is recommended the technician have a minimum of 5-years experience.
- A detailed written report with photo's must be provided.
- Anything less is **NOT** reliable.

Which Ground Tester(s) Will Meet Your Needs

- Ground testers come in two versions. Stake type testers & clamp-on ground testers.
- Before you decide which style will meet your needs, understand the benefits & limitations of each tool.
- Suggested sites: Megger.com and AEMC.com

Stake-type 3 & 4-point Testers

- 3-point FoP testers are reliable and a bit more accurate
- Require much more real estate
- Requires isolation of electrode under test
- More time-consuming and labor-intensive
- 4-point testers also measure resistivity



Clamp-on Ground Resistance Testers

- Clamp-on testers require little real estate but limited cable size
- Nearly as accurate
- Requires a return path; cannot measure an isolated electrode



The Fall-of-Potential Checklist

- Identify and locate any and all conductive elements (wires, pipes, cables, metal fences, tree roots, etc.) or any condition or conductive element in the soil that would impact the test results.
- To insure accuracy of a “stake type” fall of potential test it is necessary to verify the test results. This is done by a completion of two additional tests that are at: 90°, 180° or at 270° from the initial test. This confirms there is no conductive elements.
- Do you have access to enough area or real estate to allow completion of two additional tests? If you cannot do both you don't have a reliable initial test.
- Verify the soil is un-disturbed and virgin soil, no fill has been added.

Fall-of-Potential Tester Checklist

- If necessary use ground penetrating radar to be sure the soil in the area can be used for testing.
- Verify the moisture content of the soil does not exceed the worst case lack of seasonal moisture.
- Test and record; the soil temperature, moisture content, PH, salt content.
- Confirm if any ground enhancement material was used when the grounding was installed. If anything other than Bentonite or conductive concrete the testing may (will) not be accurate.

Multiple Rod Lengths Coupling

Lowering Ground Resistance

- Add More Rods
- Deep Driven Rods
 - Threaded Couplings
 - Compression Couplings
 - Exothermic Ground Rod Splice



Grounding & Bonding for Lightning

- Lightning strikes most often occur to outside wiring.
- Grounding & bonding the electrical system will assist the flow of lightning into the earth.
- The electrical system is a calibrated spark gap.
- Over voltages will arc to a lower potential.
- If the lower potential is capable of handling the current that will develop you divert what would otherwise be trouble.
- Low resistance & impedance ground paths facilitate that to happen.

Bonding to the Highest Level

- Bonding should be designed and installed to a level that will provide a very **low impedance path** to the facilities electrical system earth ground. 5 Ω desired.
- Bonding must be robust, **use stranded cables** and have a “flow” to the earth ground.
- Bonding **must not have hard bends**.
- Exothermic welds, never solder.

Bonding Installation

- Electrical service entrance ground bonds should be to a **common bonding bar** that is both robust and provides a low impedance path to earth ground.
- All bonds should be **exothermic welds or double lugs** and made using conductive grease and robust hardware. (lock washers, double nuts, etc.)
- This bonding bar should be the **common point of all bonds**: Neutral, plumbing, water, gas pipe, lighting protection, Ufer, building steel, all metallic elements of the electrical panels, conduit, etc.
- Allow for the flow of lightning energy imposed on any and all elements of the electrical system.
- Bonding must be “serviced”, verified, checked, etc.

Surge Protective Devices

AC Power Surge Protection Devices

- SPD are classified by UL based upon how they are installed
- Type “1” – Hardwired ahead of the main means of disconnect.
- Type “2” – Hardwired after the main means of disconnect.
- Type “3” – Cord connected or direct plug in devices.
- Type “4” – Component Assemblies – One or more components that are listed as part of Type 5.
- Type “5” – Individual components such as MOVs.

What To Use Where (ratings in kA per mode)

- Service Entrance – 100kA to 300kA.
- Primary Distribution – 100kA to 200kA.
- Distribution “outside loads” – 100kA to 200kA.
- Distribution panels – 50kA to 100kA.
- Sub Panels – 40kA to 50kA.
- Outside Loads – 40kA to 50kA series device.
- Critical Loads – 50kA series device.
- Point of use – Cord connected 10-20kA.

At the Service Level

Type 1 devices

150 kA per mode minimum suggested



At the Feeder Level

Type 2 devices

75 kA per mode minimum suggested



At the Device Level

Type 3 devices

25 kA per mode min.

50 kA if critical load



MOV Based SPD

- SPD is a diversion device, it shunts the lightning energy to ground.
- SPD must have a good ground to divert the energy
- If you don't have a good low-R ground, don't install SPD's. It will make matters worse.

MOV



A Failed MOV

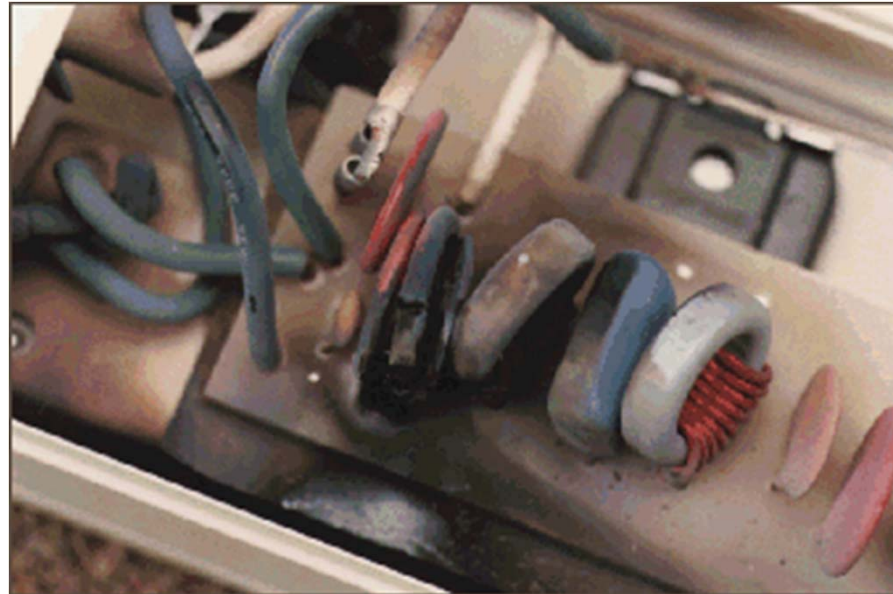

MOVs

- MOVs are bi-directional components.
- MOV's degrade with use.
- SPD references ground conductor.
- A surge can sometimes come from telephone or other connections to ground. Thus, you want low resistance to earth.

SPD Characteristics

Surge Suppressors Should Have:

- All-mode protection: ϕ - ϕ , ϕ -G, ϕ -N, N-G
- Listed to UL 1449, latest version
- High Joule (W•Sec) rating
- Have filtering, fuses, indication
- Must be well-grounded to work

SPD Inspection & Testing

- Most SPD lights only mean you have power.
- Industry people call SPD lights, “idiot lights”.
- Some SPD lights are diagnostic.
- Ask the company how their lights know there is a change in the status of the SPD.

SPD Testing



Surge Suppressor Location is Critical



Lightning Protection Systems

- The codes and standards for lightning protection systems **allow building steel** to be used as the “down conductor”.
- Simply put the **steel framework of a building becomes the conductor** for lightning.
- What happens to the metal conduit that is in contact with the building steel?

General Wiring Practice

Surge Suppressors should be connected to a full size grounding conductor

By “full size” I mean at least equal to the phase size



Wire Length is DELAY!



This SPD Will Not Protect Panel



AC Power SPD & Facility Protection

- Proper “facility” protection is much more than the installation AC power SPD.
- Coordinate with other service providers: CATV, Telecom, etc.
- Be sure they have connected properly to the ground bonding system.
- Be sure they have also protected their services.

Installation Conditions

- Geographic Considerations.
- Building Construction.
- System Topology.
- Power distribution system configuration.
- Control cabinet or equipment location.
- Interface considerations.
- Customer specific requirements.

WRZN

Multiple things to learn from this site



Where to Place Electrode?

A/C makes perfect moisture drip



Original Electrode

Original was 280 Ω



New Electrode

After new grounding
3.4 Ohms



Telephone Service

Lightning does not
travel up!

Ground bar was there
all the time.



Mutual Induction

Neat but induction
will worsen situation



Lightning is Frequently on Telephone System

Telephone and cable TV mixed on common ground bar. Not bonded to electric service grounds.

Lightning will be transferred to cable TV, then electric system or vice-versa

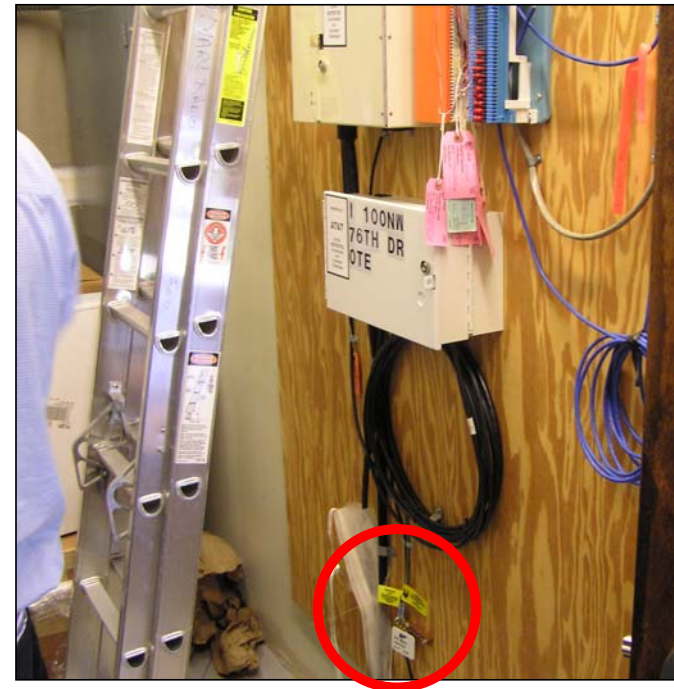

General Guidelines

Circuitry

Voltage Drop

Full Size Conductors

General Principals

• Source: Dranetz Field Handbook

Internal Causes of PQ Problems

- Poor electrical system design and layout
- Lack of or inadequate electrical system maintenance
- Shared mixed load distribution panels
- Too many outlets per circuit
- Mixed load use on circuits
- Inadequate and shared neutrals
- Poor, inadequate and shared grounding
- Intermittent connections
- Standard equipment and wiring (inadequate conductors, IG, etc.)
- etc.

Avoiding Daisy-Chaining Equipment

Each piece is home-runned to an SGB or MGB

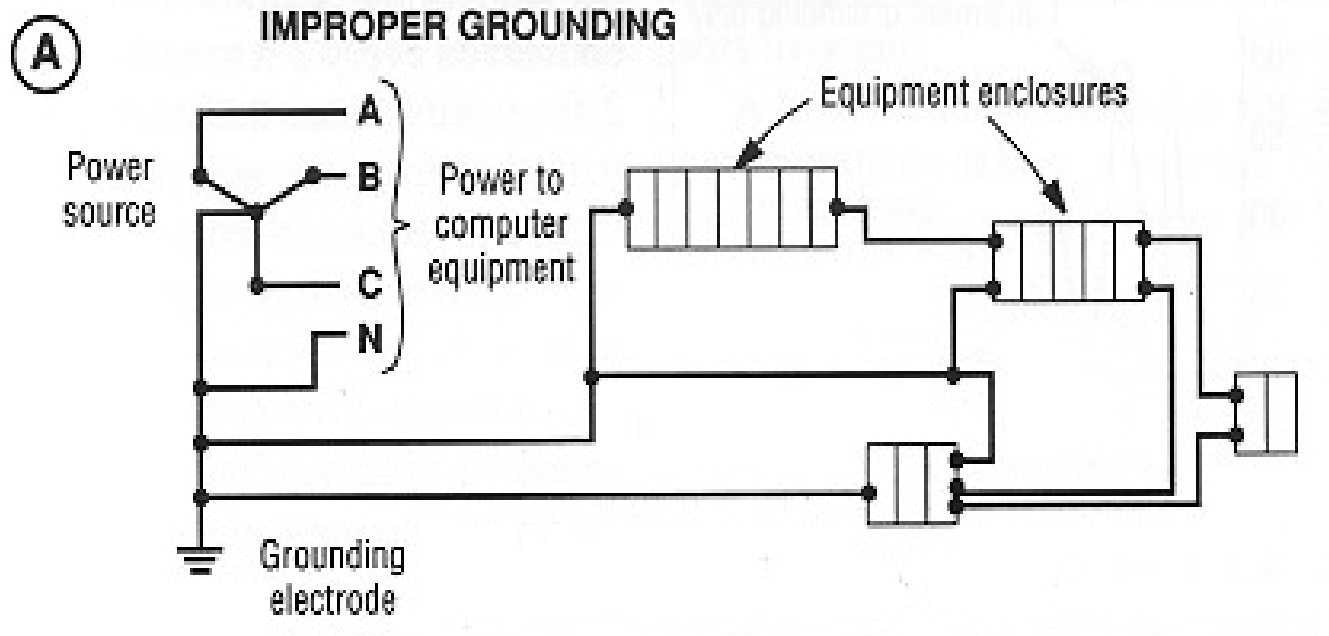

Only N-G Bond is at Service (or separately-derived system)

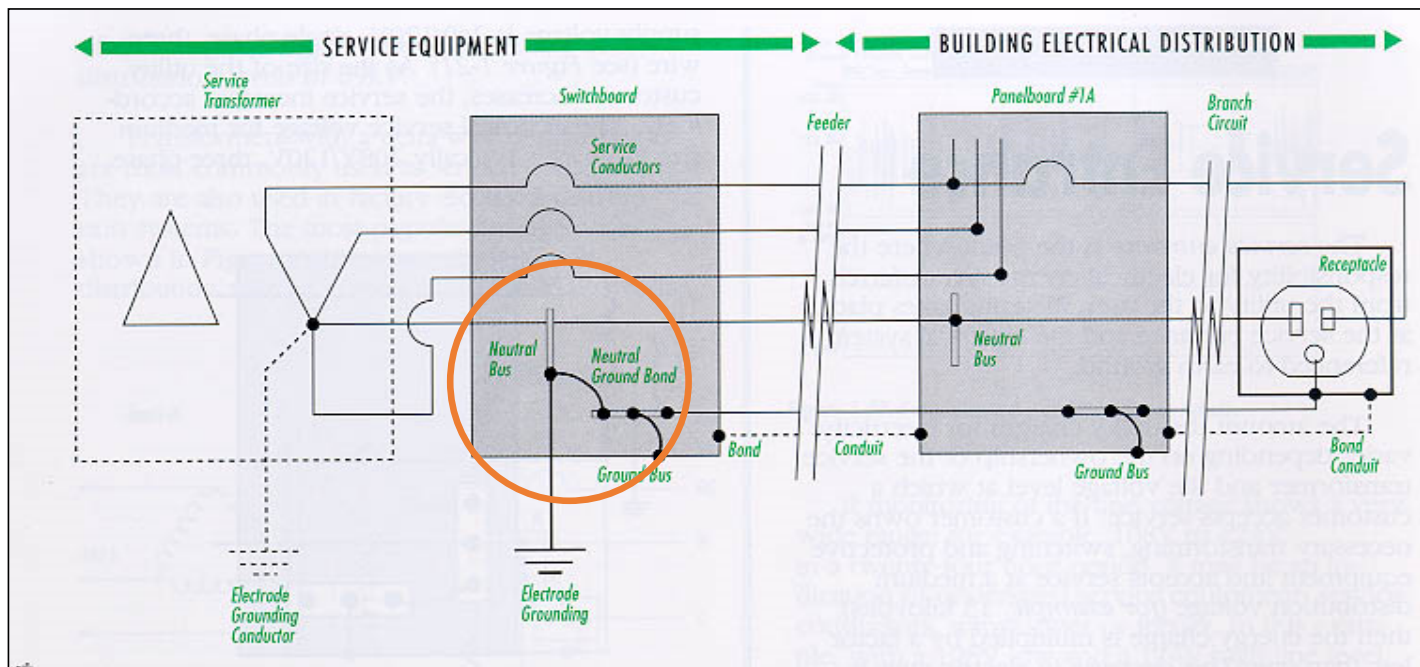

• Source: Dranetz Field Handbook

Avoid Conduit as a Ground Path

Can you imagine a
joint every 10 feet?



Full Size Equipment Grounding

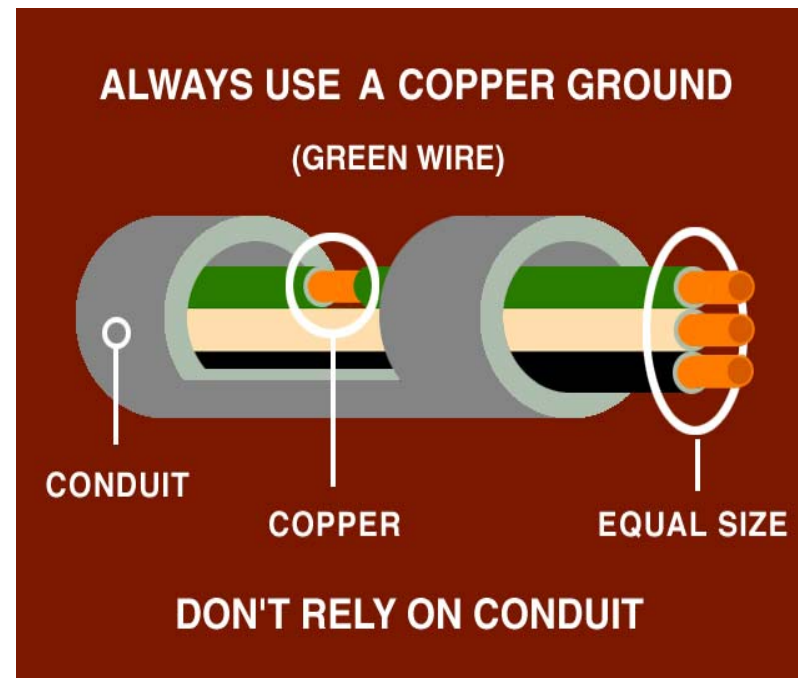

General Wiring Practice

Sensitive loads should be isolated:

- Separate branch circuits
- Separate panelboards
- Separate feeders
- Separate transformers

Recommend Higher Distribution Voltages

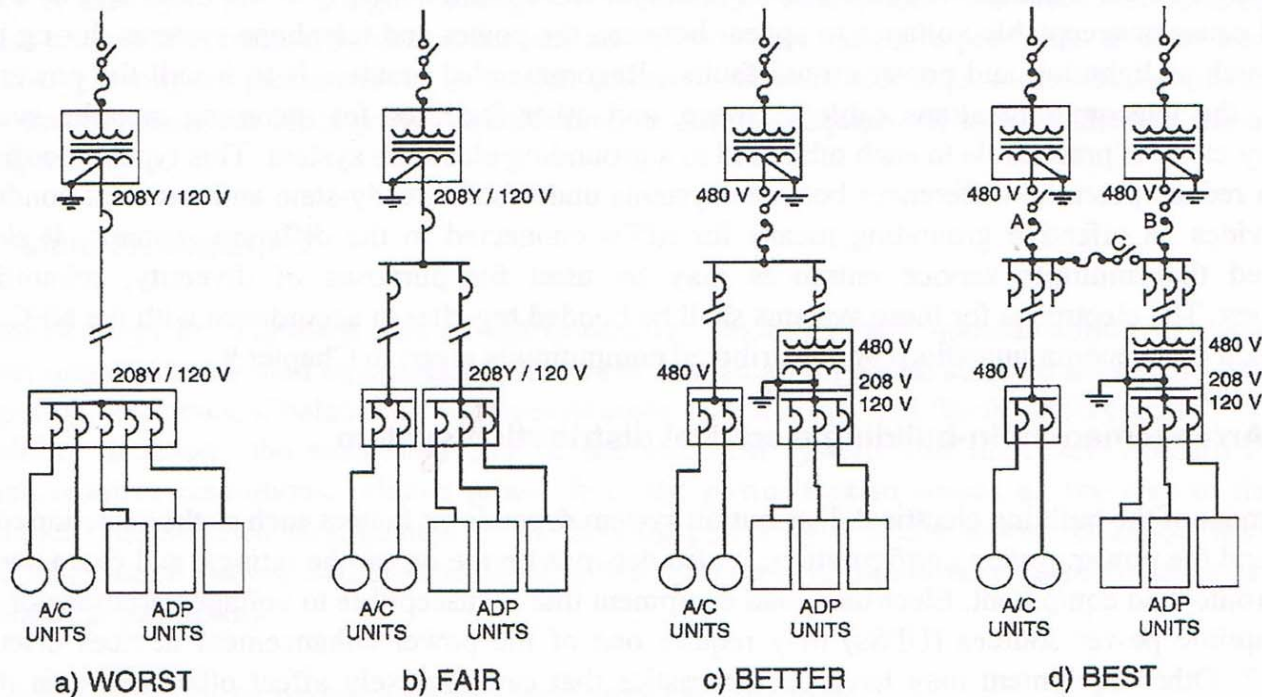

source: IEEE
Emerald Book

Limit the Number of Outlets Per Circuit

- 3-6 per 20 amp. branch circuit (maximum)
- Prevent interaction among loads
- Limit voltage drop by exceeding minimum wire gages

General Wiring Practice

- Use Surge Suppressors, connected to a full size grounding conductor
- - at the service
- - at the panelboard
- - at the load

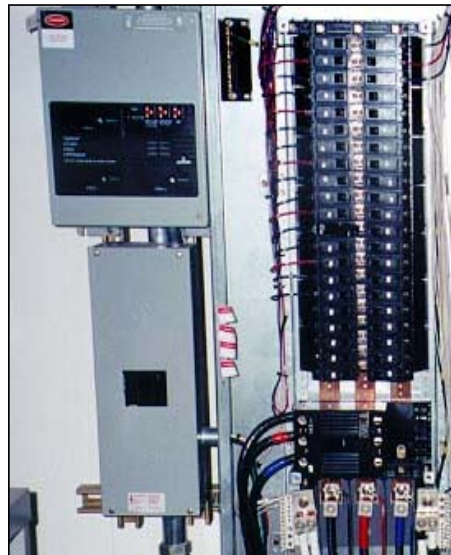

General Wiring Practice

Surge Suppressors:

Must be well-grounded to work
(5 Ω recommended if possible)



Caveat

MOV's can degrade with use!

Let's take another
10 minute Break

10 minutes, no more please

Here's What Proper Surge Suppressors Can Do



This Building Houses ATM Network



Data Center Inside



Lightning Hit Service Drop



Credit Union's Data Center 480Y/400-Amp Meter Base Disconnect

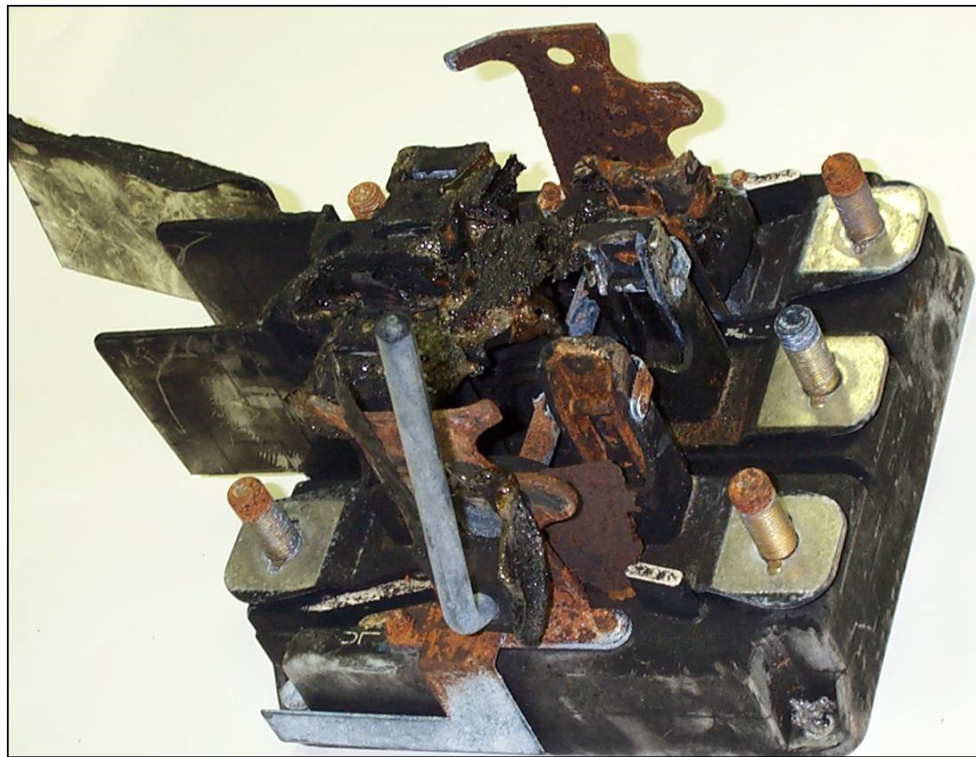

7 Levels of SPD's



Lightning vs. The Meter Base

- The meter base took the brunt of the lightning damage.
- The meter base housing was “bonded” to the ground system.
- The impedance of the path to the switchgear higher than the path to the ground rod system.
- **Nothing inside the data center was damaged. No downtime.**
- The most robust was a SPD was rated at 120kA per mode.

Lightning vs. The Meter Base

- The lightning energy imposed on the electrical service went to earth ground on the conductor that bonded the meter base and other metal cases of the electrical system to the ground rod system.
- The ground resistance of the service: 4.3 Ohms (Fall-of-Potential) tested.
- The only damage was to the “outside” elements of the electrical service. (Meter base, gutter work, pole, transformer, utility wires, etc.)

SPD's Need Good Ground

Without a good, low impedance ground to discharge the energy to, SPD's don't work, may make matters worse.

Bank's ATM Data Center

No downtime

No equipment damage

Cost around \$40,000

What do you suppose the downtime would have cost?

Example of Reasonable Practice

Macomb County, Michigan 9-1-1 facility

Note Tower in Rear



Gas and Water Services Bonded



Labeled So No One Removes



Conductor Welded to Base, Not Tower Leg



Tiered grounding
so each level has less energy to
dissipate

Coax Braid Bonded on Vertical Run



Then to Strap at Bulkhead



Inside Radio Room



Larger Data Center

- Involta, Cedar Rapids, Iowa - 18,000 sq. ft.
- Akron, OH – 26,400 sq. ft.



Rooftop Termination Devices

- Note transition from aluminum lightning protection devices to copper for down conductor



500 kcmil Ring Surrounds Building



Supplemented by vertical electrodes every 100 ft.

Each electrode has an inspection well

Dual Electric Circuits

Dual utility feeds, 2- 2500 kVA transformers,
4- 750 kVA generators, A&B circuitry



Each Rack Tied to Overhead Bus

Connection of equipment to rack ground is customer choice



Cabinets to Overhead Collector



From Racks Bus Grounds go to SGB



Each Room Has SGB (Then to MGB)

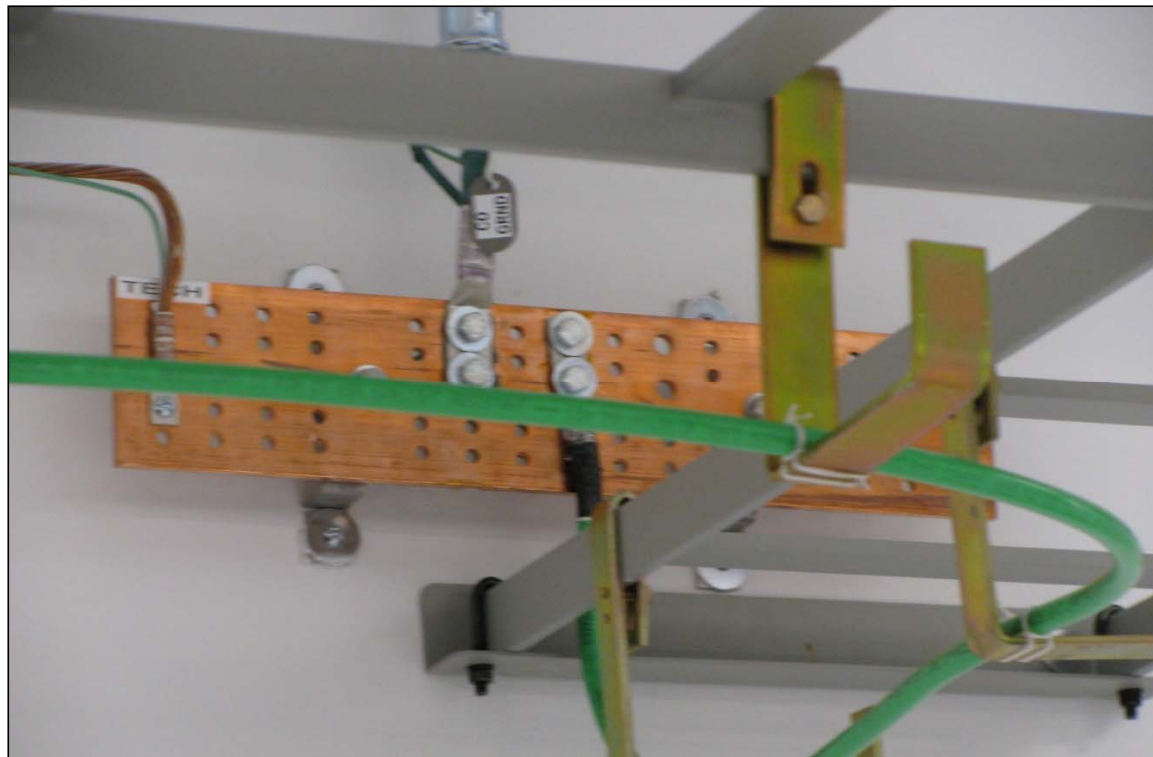

From SGB to MGB



Very Large Data Center

800,000 Sq. Ft. in Boston
above this Macy's



Markley Data Center

Several Floors of Rented “Co-location” Space



Each Step-down Transformer is K-rated

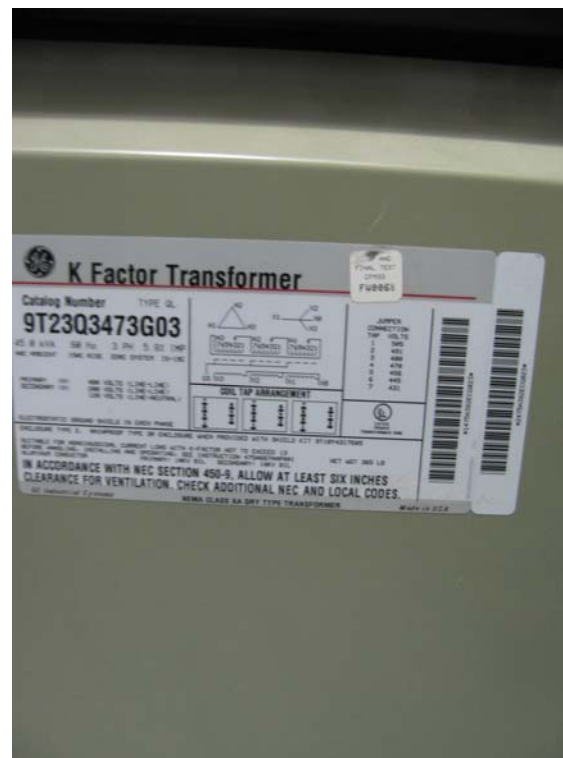

Separate Runs to Master Ground Bus

Other design features:

- #10 AWG for branches
- 2% voltage drop max
- 6 outlets/ckt max
- K-factor transformers
- Similar rack grounding as previous



Master Ground Bus (MGB)

- Note that all conduits are labelled.
- MGB located at lowest point in building.



MGB Connections Labeled

Every connection neatly labeled

All connectors double-bolted

Co-Sentry
Data Center



Imagine a Joint Every 10 Feet?

Never Rely on Conduit as Ground Path

Always use a full-sized separate copper ground conductor



Start With Ring Ground

Suggested size
4/0 AWG or better

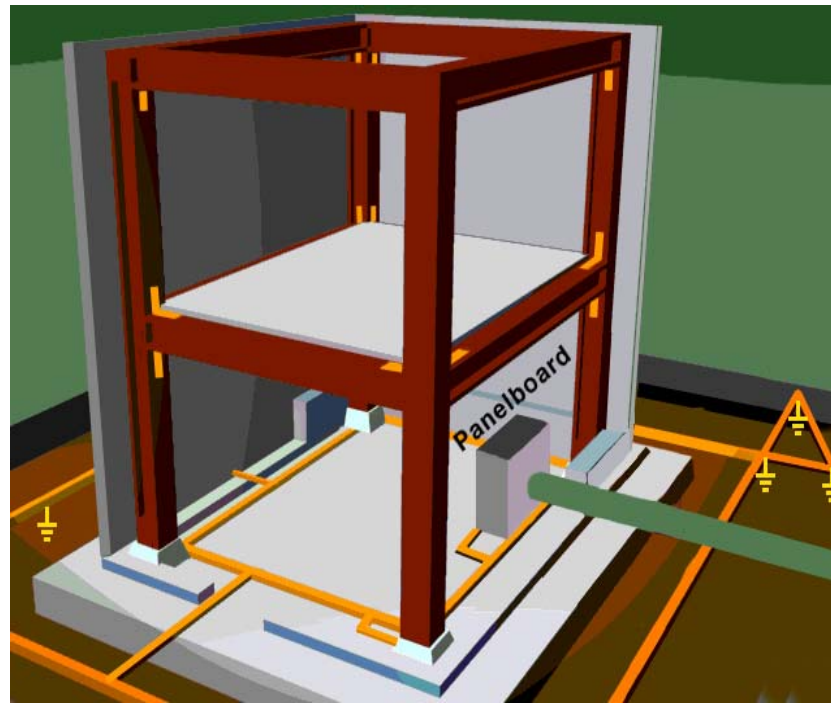

Network of Air Terminals

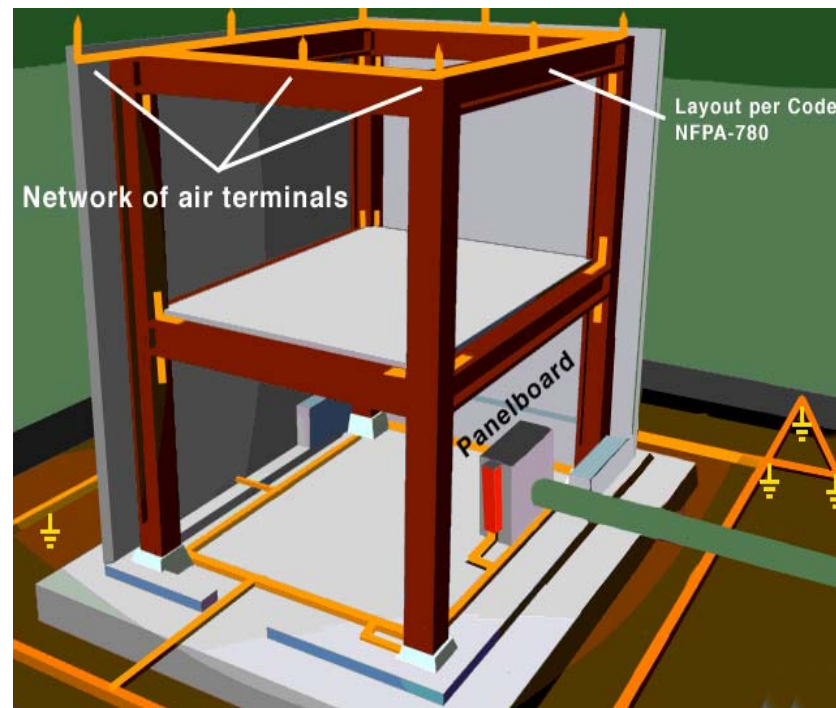

Heavy Duty Down Conductors

Don't use steel framing
as down conductor

Isolate down conductors
from framing

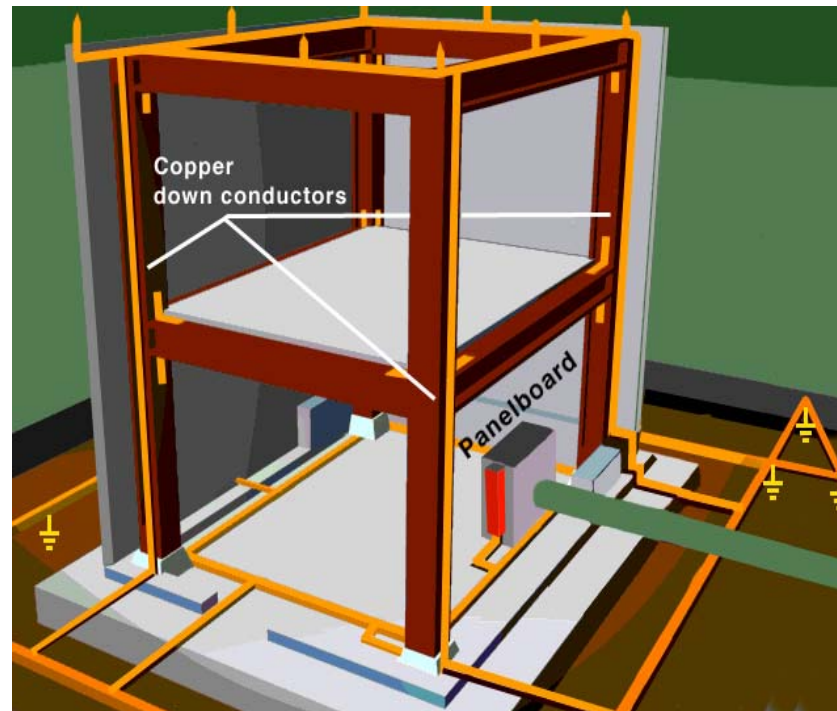

Do Not Use Building Steel For Ground Reference

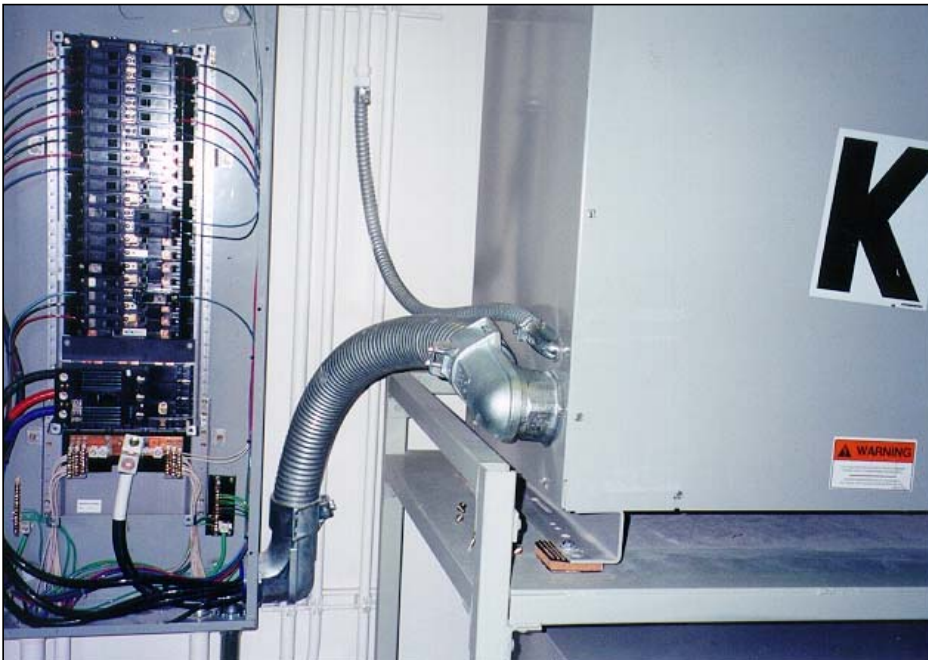

Surge Suppression

Don't omit telephone
or cable TV

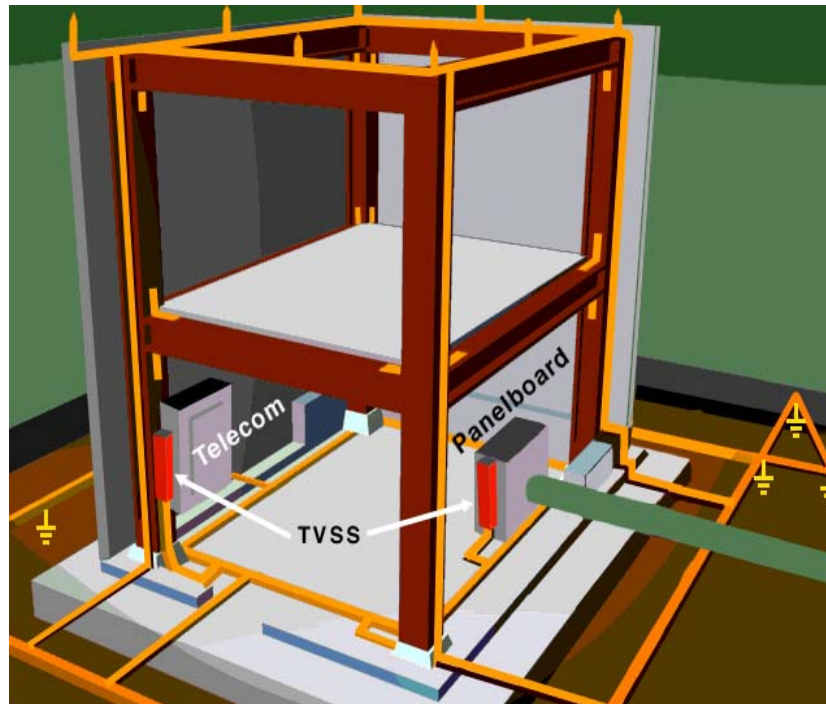

Overall Result

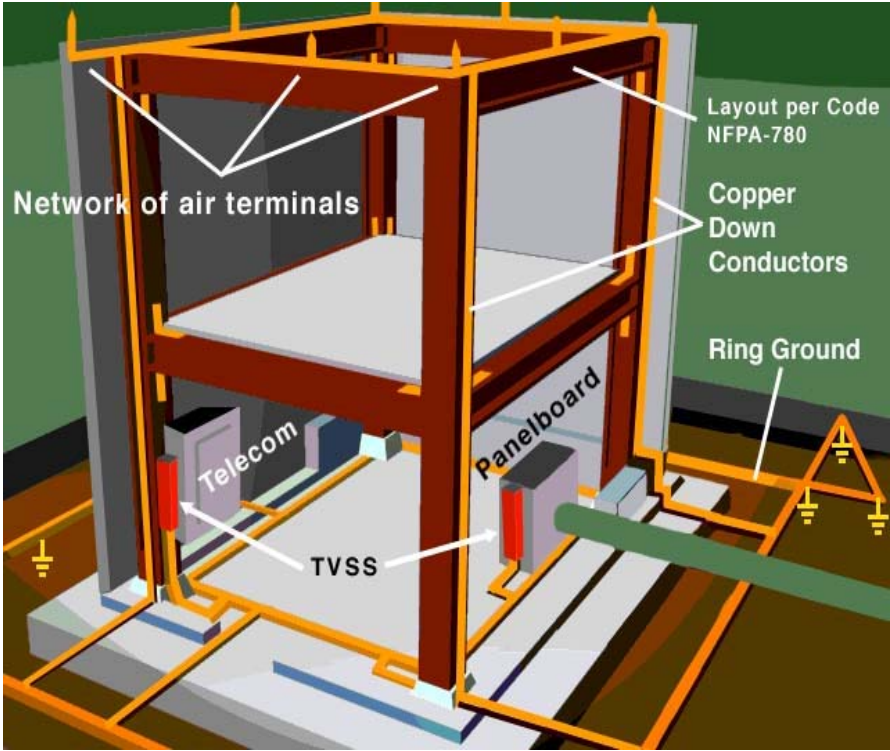

System Grounding

There should be ONE and ONLY ONE point connecting the neutral to the exterior grounding electrode system

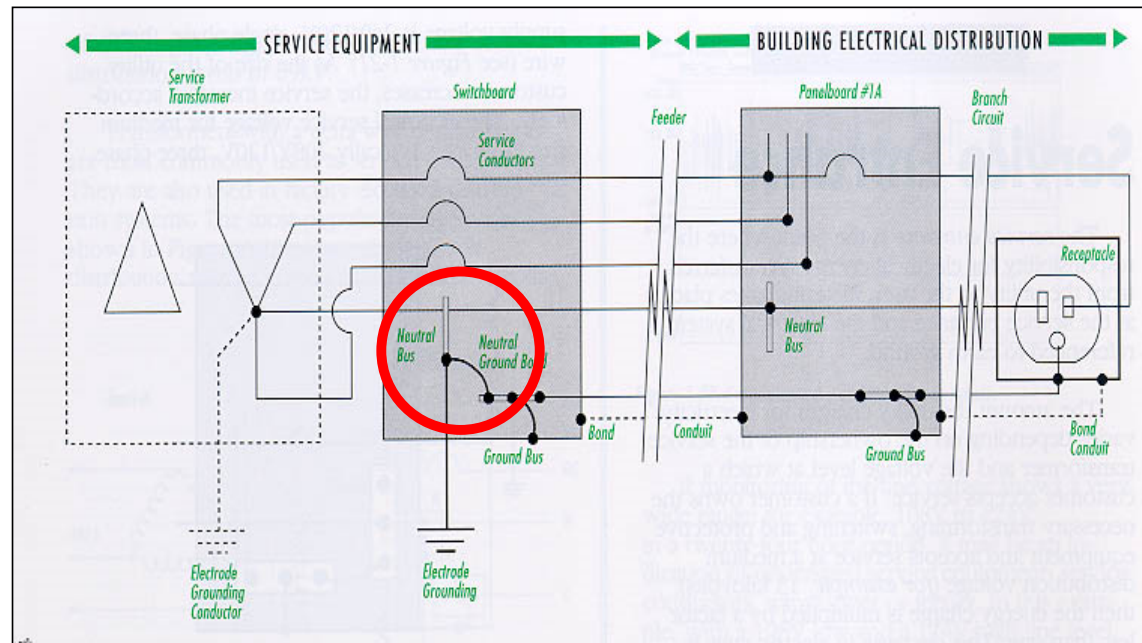

Isolated Ground Circuits Recommended

We recommend all sensitive equipment should be connected to an isolated ground circuit.

Nothing else on it.



Trap Harmonics

Shielded isolation transformer
helps isolate harmonics



What Is a Shielded Isolation Transformer?

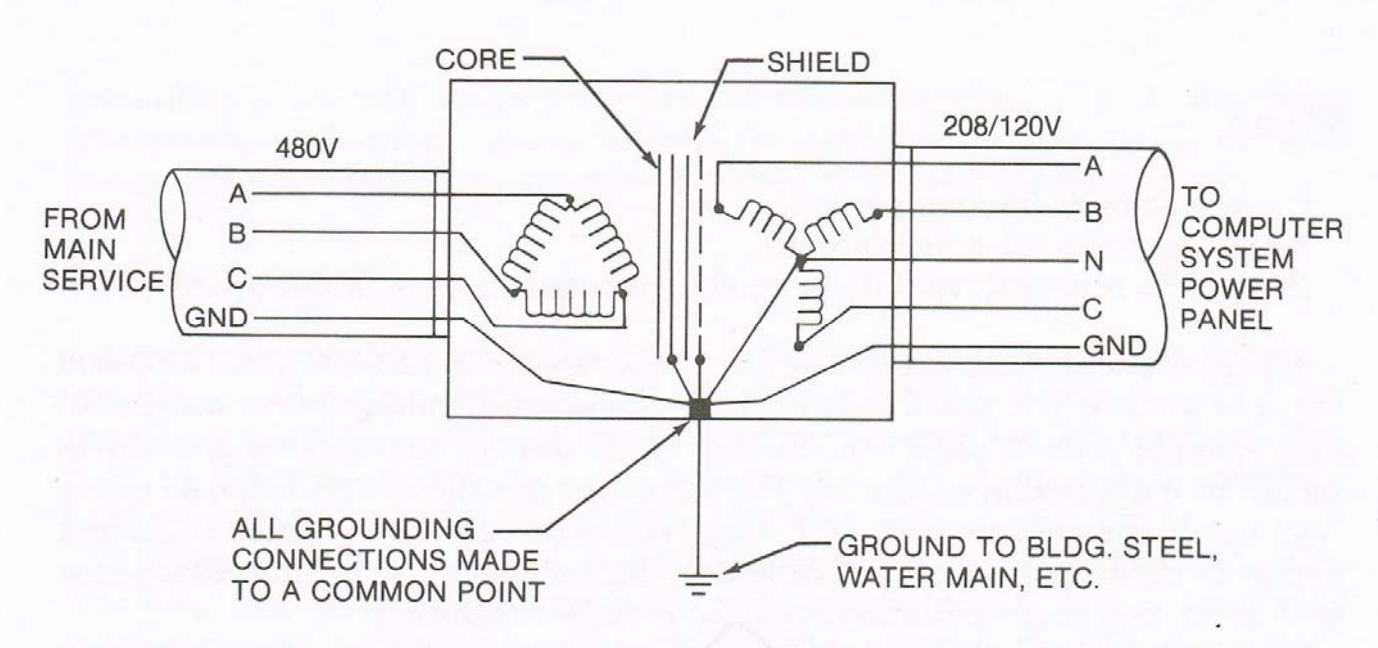

Ref: IEEE Green Book (Std 142)

Neutral Size To Handle Harmonics

Use a 200% rated neutral or separate neutrals per phase

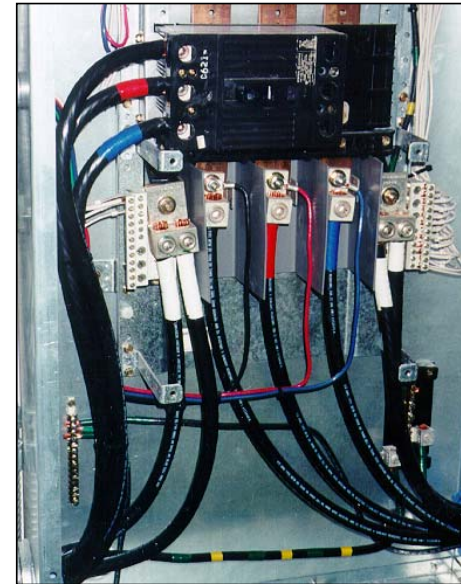
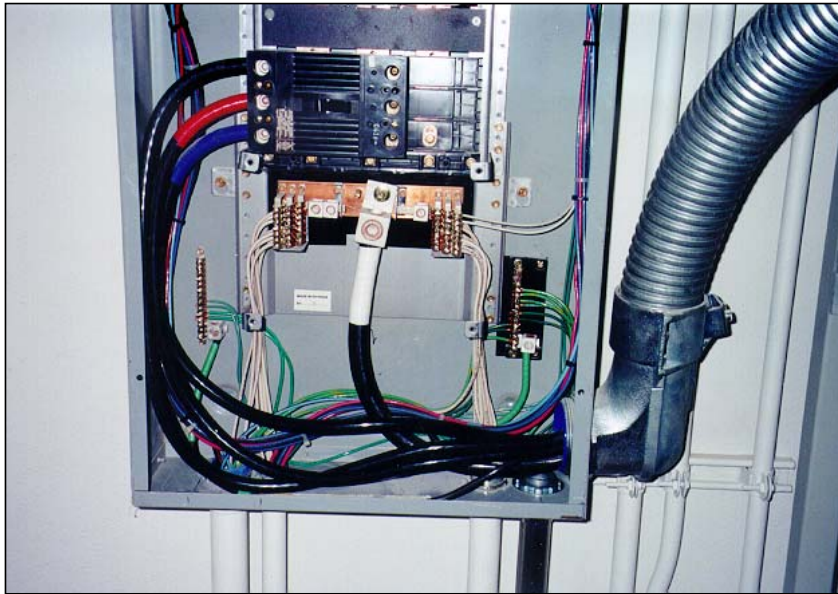

Check For N-G Bonds

Interior:

- Check neutral – ground voltage
 - could mean harmonics
- Check for ground current
 - illegal N-G bonds

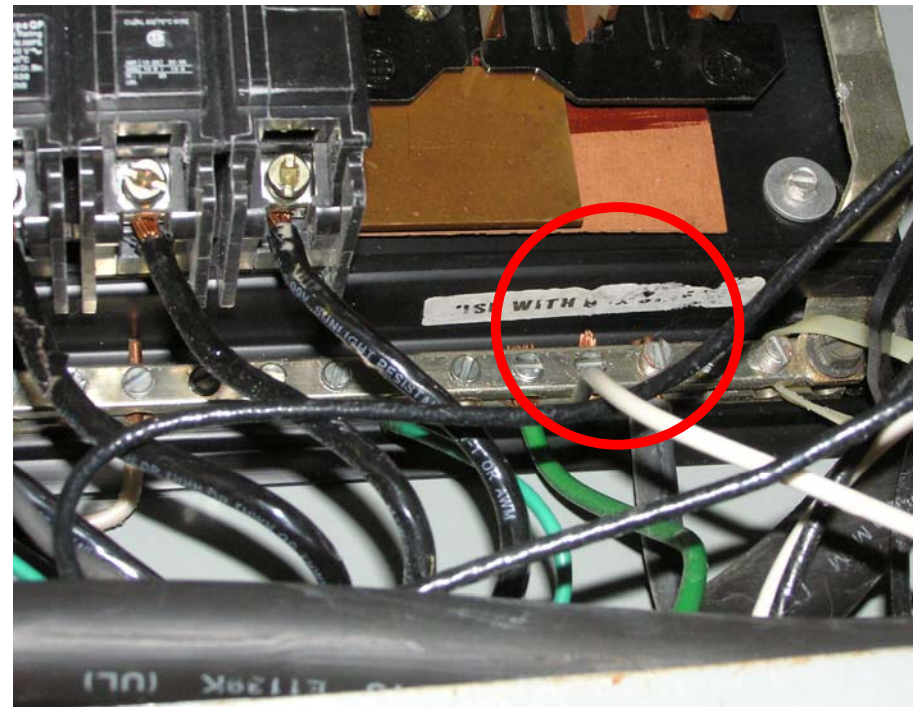

Use Only Listed Connectors

- Look for UL Listing on all electrical equipment
- Water tube is not a good conductor AND not usually an electrode

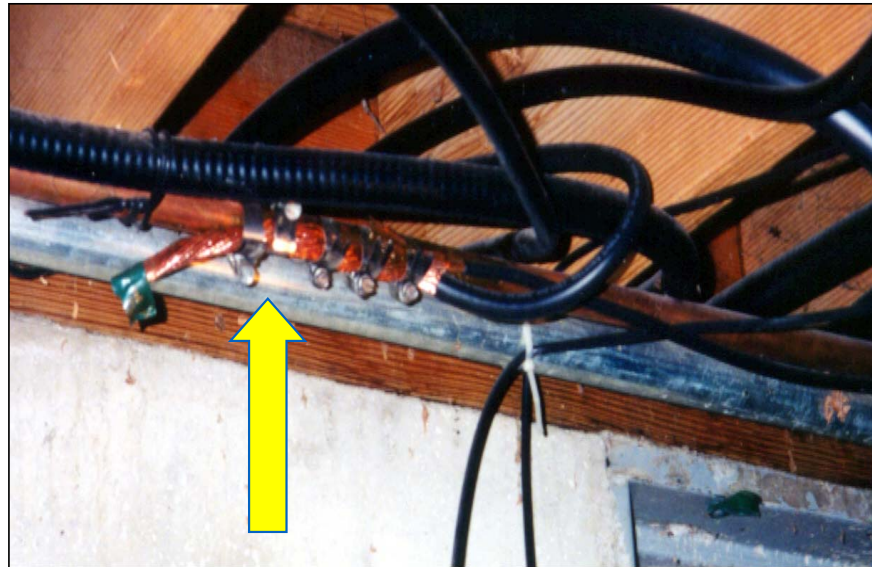

Limit Voltage Drop

- NEC does not mandate voltage drop
- Limit voltage drop to 3% maximum in branch circuits, less if practical
- How? Larger wire gage than Code minimums.
- 3-6 outlets per circuit maximum
- Separate individual circuits for sensitive equipment

- It's the law in CA, NY, IL, maybe other states

Interior Wiring

- Use separate circuits, panels for sensitive loads
- IG circuits recommended
- Limit receptacles to 3-6 per circuit
- Limit voltage drop to 3% or less (Code) 2% recommended.
wire gage, circuit length

Other Considerations

- Rusty or corroded connections
- Unlisted components
- Different metals
- Undersized conductors

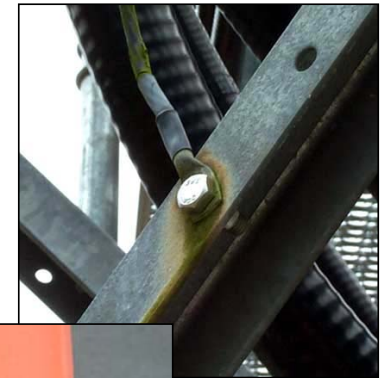

Low Resistance is Vital

- Under 5 ohms recommended
- Spacing 2X length
- Below frost line



Choice of rod types

Pick the right electrode and backfill
for the soil conditions

Backfill

- Bentonite is the recommended backfill
 - It's cheap
 - It's benign
- Conductive concrete second

Be wary of anything
containing graphite or carbon



Bentonite

- Bentonite is a Ground Improvement Material.
- Bentonite is not a Ground Enhancement Material. (There is a difference.)
- GIM is:
 - Naturally Inert.
 - Compactable & soil compacting.
 - Has low and stable resistivity.
 - Able to maintain low resistance with minimal fluctuations.
 - Does not leach with time.
 - Economically viable.

Augured Hole with Rod & Bentonite

- A hole is augured into the soil.
- The hole is filled with Bentonite.
- A ground rod is installed into the center of the augured hole and the conductor is exothermically welded to the rod.
- Water is added, the Bentonite swells and fills all the voids.

Benefits of Bentonite

- The formation of an electrolyte when Bentonite is ionized by water & this layer around the grounding electrode serves as a pathway for dispersion of lightning charges.
- Increased current dispersion of lightning when compared to installations lacking Bentonite.
- Bentonite is an approved Ground Improvement Material and environmentally benign

What is a Chemical Ground Rod?

- Simple version: Salt in a Copper pipe with holes drilled into it that is installed in the earth where the moisture will cause the salt to leach into the soil.
- The truth, it is a very viable grounding solution “IF” you understand what it is, what is needed to maintain it (AKA Replace it in time).
- The bottom line is what works in one environment may or may not work in another.
- Use what is most cost effective, sustainable and reasonable in cost for your application.

Copper Pipe Full of Salt Will Last How Long?

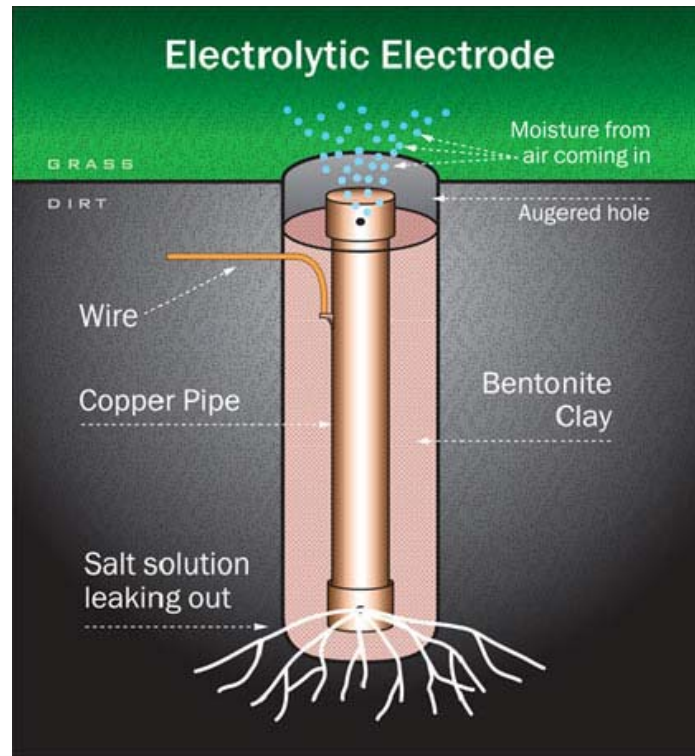

Chemical Electrodes

Salt-filled pipe after 7 years, Las Vegas suburbs



Ground Enhancement Material

- GEM is a product that is always subject to a quality control process that would insure it is not corrosive.
- Not knowing if you are installing a highly corrosive product that will be all around a soft metal (copper) is not a wise decision.
- If you wish to ignore the issue with corrosion, just use the “cheap version” of GEM, Rock Salt or fertilizer of some type.
- Carbon-based or “enhanced” products are known to be corrosive and not recommended.

Galvanized Rod After 7 Years



Galvanized Rod

$\frac{3}{4}$ inch to pencil-thin after 7 years in Las Vegas area



Ground Rod in Conductive Concrete

Takes advantage of the fact 50% of the earth resistance is within 6" of the rod.

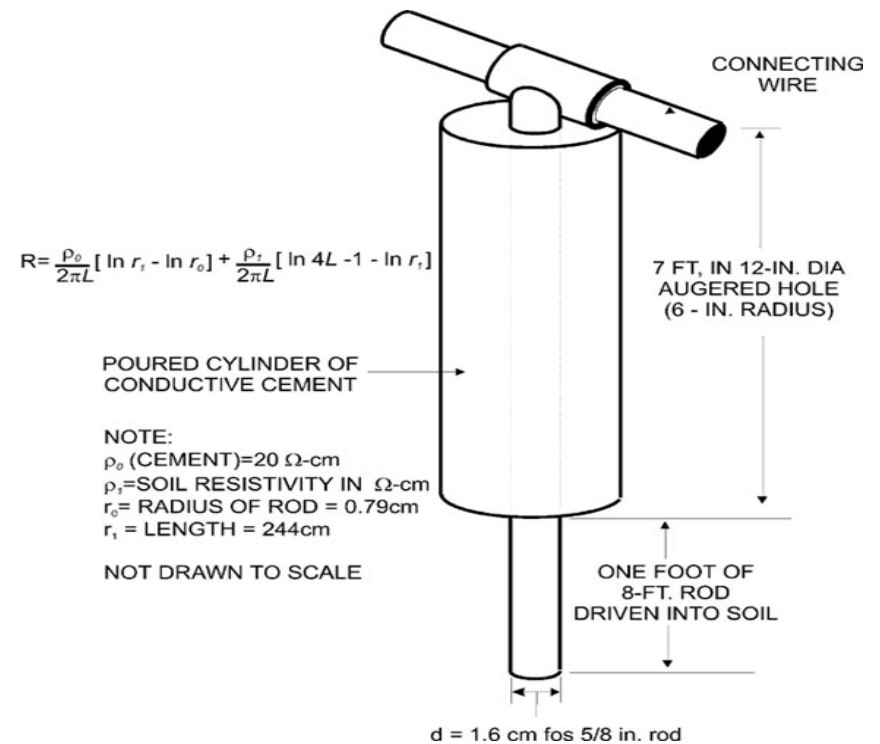

Ground Rod in Conductive Concrete

Electrode is surrounded by conductive slurry



Conductive Cement

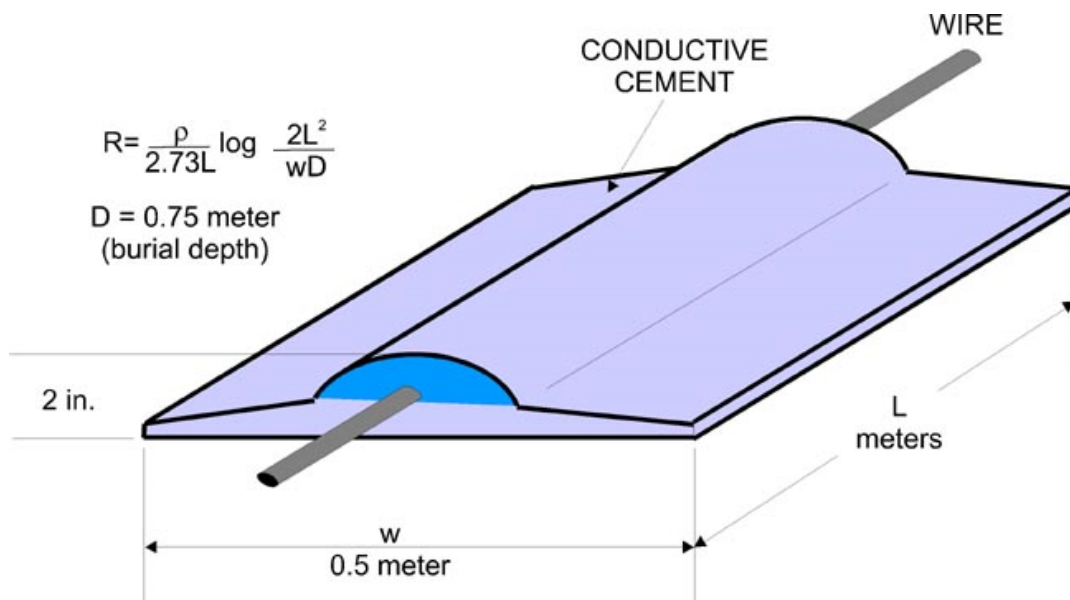

- Side benefit: Makes the copper much harder to steal.

First Step

Get the wiring and grounding right

This may solve the problem at minimum cost!

Grounding System Must be Checked

Check resistance of grounding electrode system annually
(or more often as conditions dictate).



Is Tower Actually Connected to Rebar?

High school had GEC buried in concrete



Building Steel Was Not Grounded

**2 transformers were grounded to building steel,
but steel was not bonded to ground electrode**



Sumter County 911

Use Harmonic Rated Panels and Transformers

Where appropriate

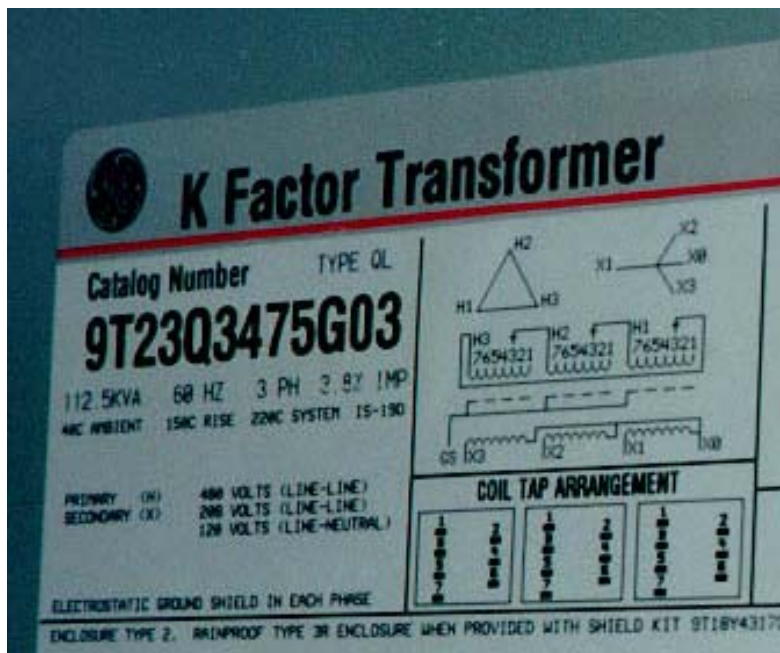

Use Bolt-in CB's

- Rather than spring tension, bolt-in circuit breakers do not lose tension. Can be retightened.
- Use twist-lock plugs/receptacles

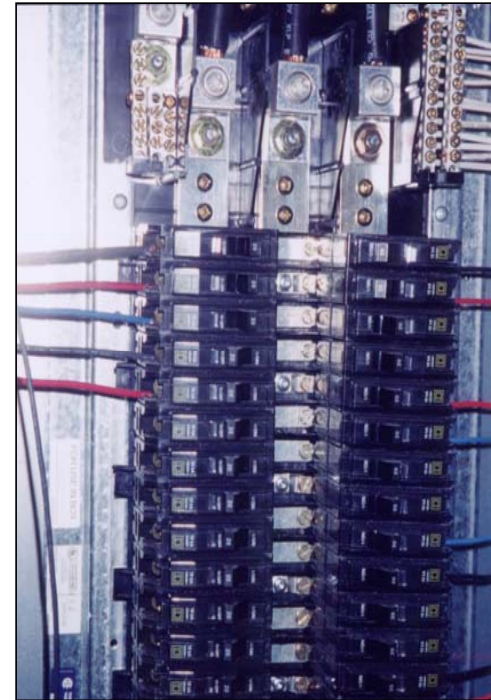

What If Telephone Line Hit?

Telephone grounding should use shortest path to MGB.

Ensure everything is actually grounded.



Look for Paint or Other Insulation



Isolation From Floor

Non-Conductive Mat Under Racks Recommended



Do Not Mix Load Types On Panel

PANELBOARD/PANNEAU/TABLERO

DATE: _____

SOURCE	LOAD / CHARGE / CARGA	CIR	LOAD / CHARGE / CARGA
1	Elevator main	2	Lobby A.H.U
3	disconnect		
5	Hyd. motor		
7	Lobby A/C	8	Surge
9	condensate unit	10	Protection
11	out back	12	unit
13	Parking lot	14	Hot water
15	Light poles	16	Heater
17	Parking lot	18	spare
19	Light poles	20	South Stair way LTS
21	OUTSIDE front GFI	22	SPare
23	N+S GFI	24	North Stairway LTS + Emergency LTS
25	GFI under	26	Elevator Cab LTS
27	PHOTO cell	28	Fresh Air make up Fan
29	Entry Lobby GFI	30	Time clock
31	Fire Alarm Booster Pnl.	32	Elevator Pit QEI
33	Fire Alarm Pnl.	34	Elevator Pit LQTS
35		36	
37		38	
39		40	
41		42	

Separate Circuits

Sensitive loads should be separated:

- **Separate branch circuits**
- **Separate ground conductors**
- **Separate panelboards**
- **Separate feeders**
- **Separate transformers**

BUT everything must be bonded together

Water and Electric Utility SCADA System

- 5 locations like this with towers and SCADA control
- Controls substations and reads meters remotely



Other Side of Same Room

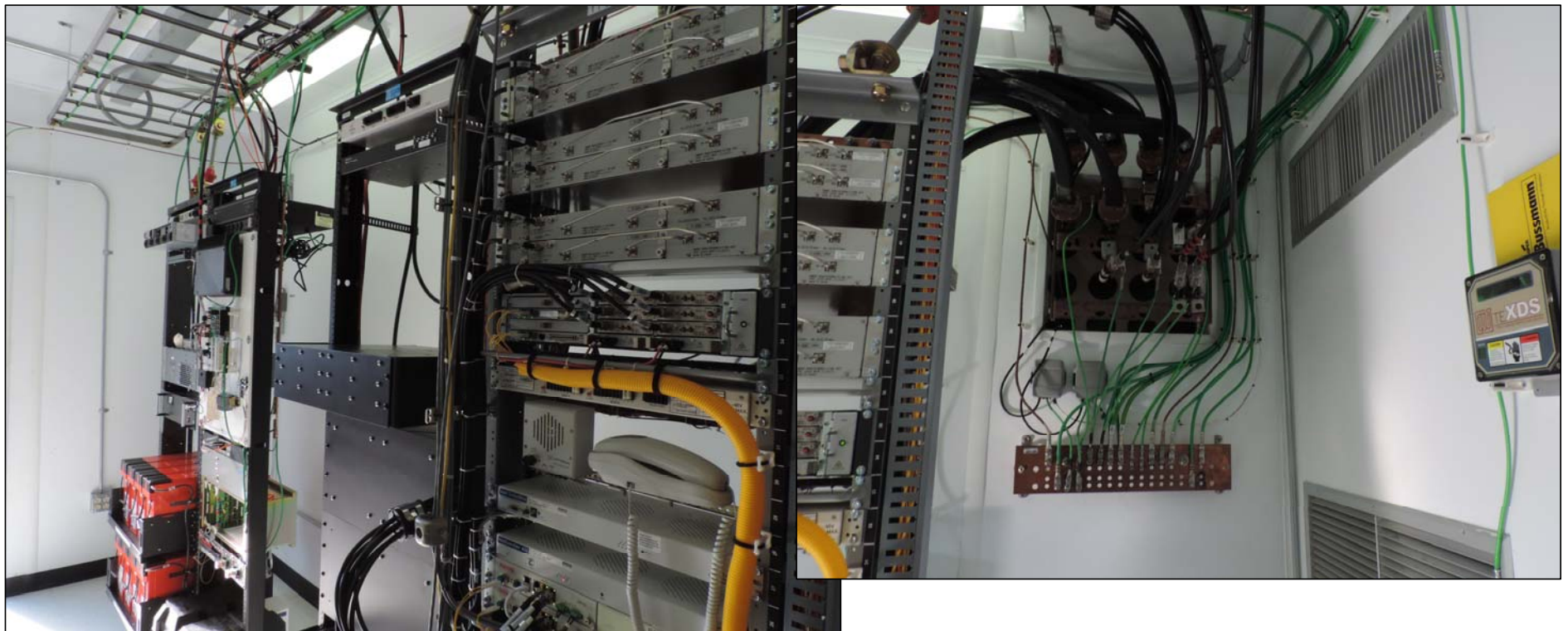

Outside Ground Bus



- Thru-wall mounting bolts are where inside bus connects to outside
- Note height (about 6 ft.)
- If lightning hits tower, electronics inside get zapped

Concrete Damage

- Path to rebar was lower than intended path to earth through electrodes
- Undersized conductor
- Original high resistance to earth?



Concrete Damage

- New conductors, new electrodes
- Tied in water well
- 2.5 Ω



Rolling Ball

150 foot radius ball (30m)

Maximum spacing:

10" rod = 20 ft

24" rod = 25 ft

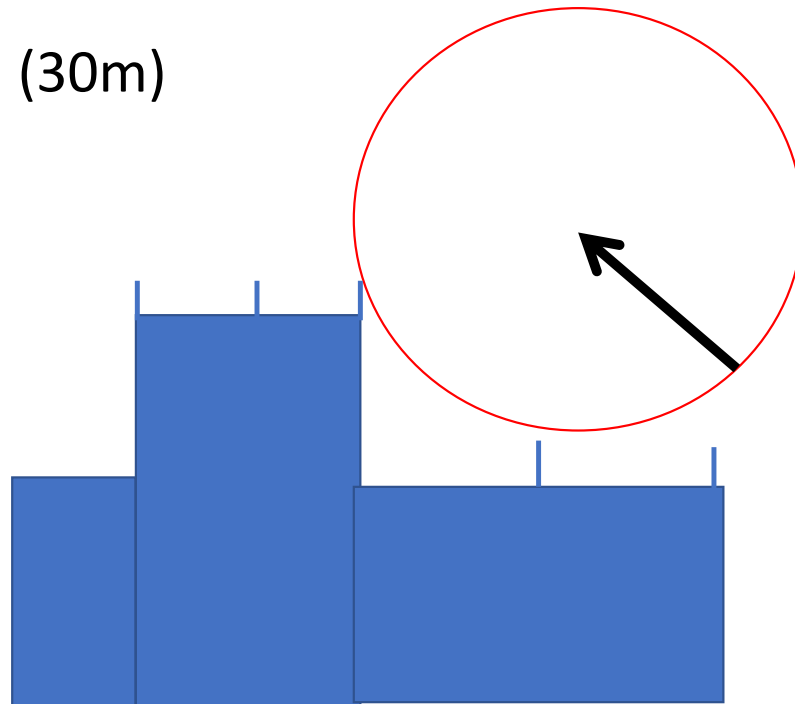

Think of a “Current Divider”

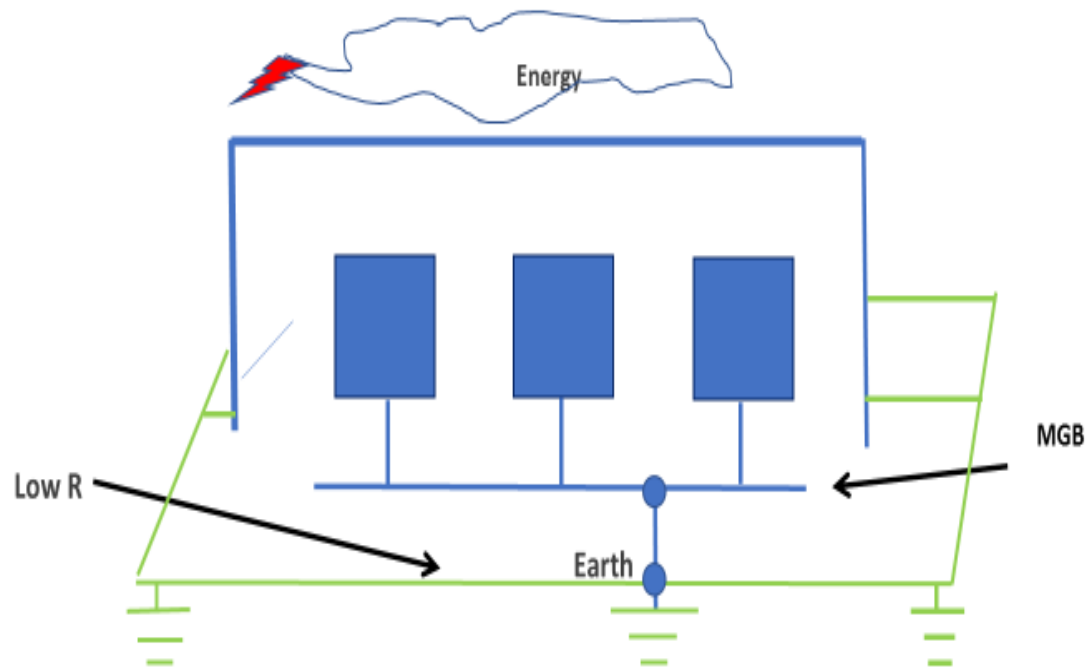

For sensitive loads within a factory or similar

Broadcast Site Desired Grounding

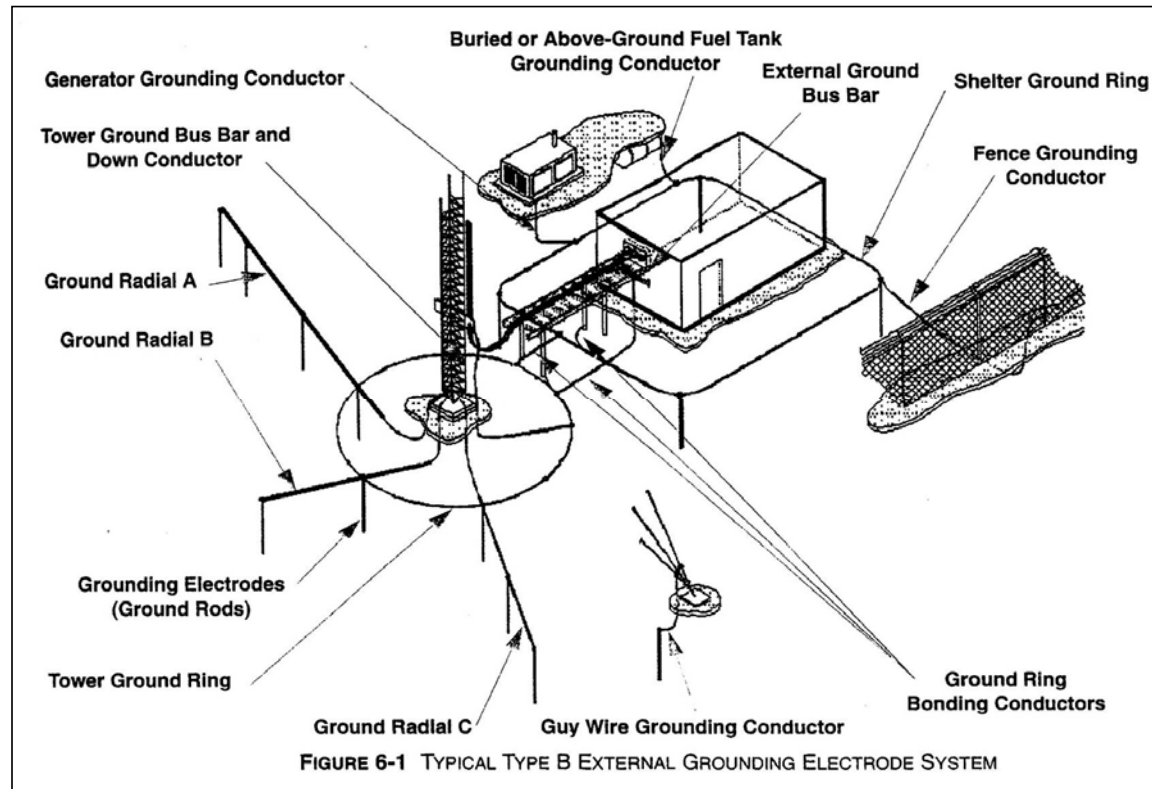

With Many Projects There Are 6 Phases

- 1. Enthusiasm!**
- 2. Disillusionment!**
- 3. Panic!**
- 4. Search for the Guilty!**
- 5. Punishment of the innocent!**
- 6. Praise for the non-participants.**

Where to you want to be on the above list at the end of the day?

Pointers

- 1. Exceed the Code, but don't violate the Code!
(Code minimum is one step above "illegal")**
- 2. You don't get what you expect,
you only get what you inspect.
Contractors do not get final payment until inspection**

Pointers (continued)

3. Have a written plan and procedures.

Insist contractors follow it.

4. Get the grounding and bonding right before anything else.

Most lightning and transient problems can be cured at minimal cost.

“A man’s got to know his limitations.”

- Clint Eastwood as Dirty Harry

Call in a power quality expert when there is doubt.

Thank You!

Contact Information

David Brender, P.E.

www.BRENDERASSOCIATES.com

(561) 894-8901 office

(917) 297-5738 mobile

Email: DTBRENDER@GMAIL.COM