

# Fundamentals of Passive Optical LAN



Brought to you by the Association for Passive Optical LAN  
(APOLAN)

Platinum Members:

**AECOM**



**CORNING**

**DZS** | EVERY  
CONNECTION  
MATTERS™

**excel**  
without compromise.



**NOKIA**

**tellabs**

 **HUAWEI**

**ITCONNECT**

[www.apolanglobal.org](http://www.apolanglobal.org)

# Course Agenda

- Day 1
  - Passive Optical LAN: 101 – Tom Ruvarac
  - Passive Optical LAN: 102 – Tom Ruvarac
  - Introduction to POL Components – Matt Miller
  - Introduction to POL Design with Hands-On – Chad Hines
- Day 2
  - Day 1 Review – Matt Miller
  - Power Survivability – Chad Hines
  - POL Testing Considerations – Matt Miller
  - POL Integration and Management – Matt Miller
  - POL Project Closeout Package Deliverables – Chad Hines

# I am a...

- A. Consultant
- B. Designer
- C. Contractor
- D. Manufacturer
- E. End User
- F. Other

# My experience with POL is...

- A. I have installed one
- B. I have turned one up
- C. I have a project now
- D. I have some knowledge
- E. I am here to learn

# Passive Optical LAN:101



Tom Ruvarac  
President, APOLAN

BICSI FALL



BicSI

# Section 1 Agenda

- Introduction to Passive Optical LAN
- Where did it originate
- Market adoption
- Knowledge Check

# *Let's Imagine...*



**A Local Area Network that...**

**This describes a traditional LAN!**



***An exciting new way...***

# **Passive Optical LAN**

*The infrastructure of tomorrow available today*



***“A Bandwidth Efficient LAN  
Architecture Providing Measurable  
CapEx & OpEx Savings”***

# Thoughts...

Henry Ford Wisdom...

*"If I'd asked customers what they wanted, they would have said "a faster horse."*

Steve Jobs Wisdom...

*"Man is the creator of change in this world. As such he should be above systems and structures, and not subordinate to them."*



**"There aren't many horse and buggies on the road and most of us don't have typewriters sitting on our desks. So why are copper networks still so widely used although they have been rendered obsolete by next-generation technologies?"** *Scott Forbes, CEO Forbes Media*

# Key Acronyms

GPON

PON vs. POL

OLT and ONT

# What is Passive Optical LAN?

Revolutionary

Economical

Efficient

# What is Passive Optical LAN?

Standards based/recognized technology

ITU G984, G987, G989

ANSI/TIA 568C

BICSI TDMM 13

Fiber Based Local Area Network

Point to Multipoint Topology

# Why Passive Optical LAN?

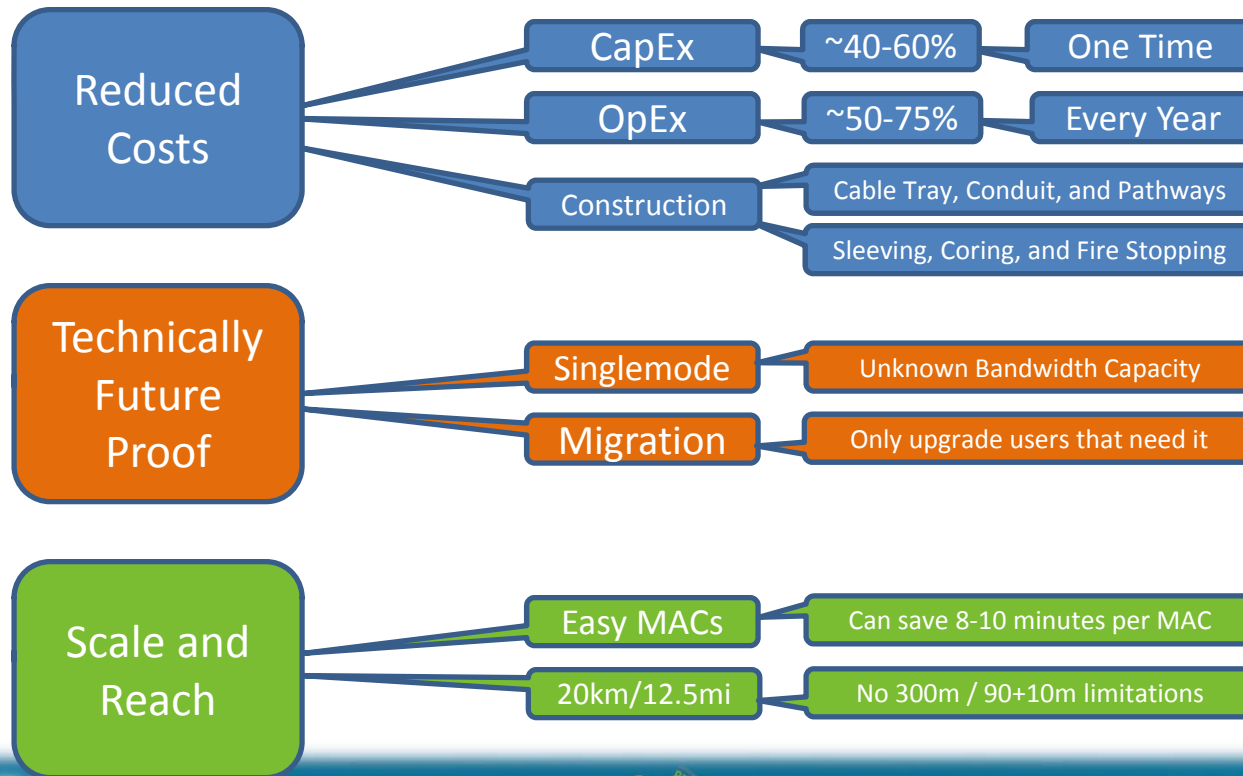

# Why Passive Optical LAN?

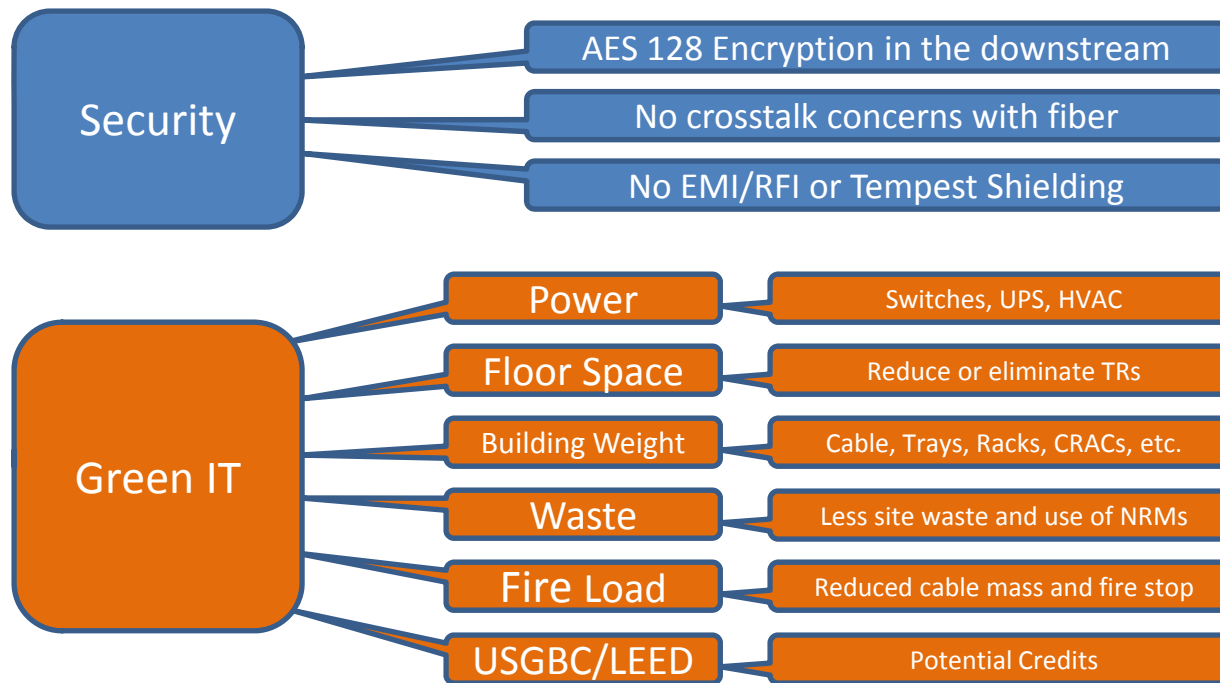

# Why Passive Optical LAN?

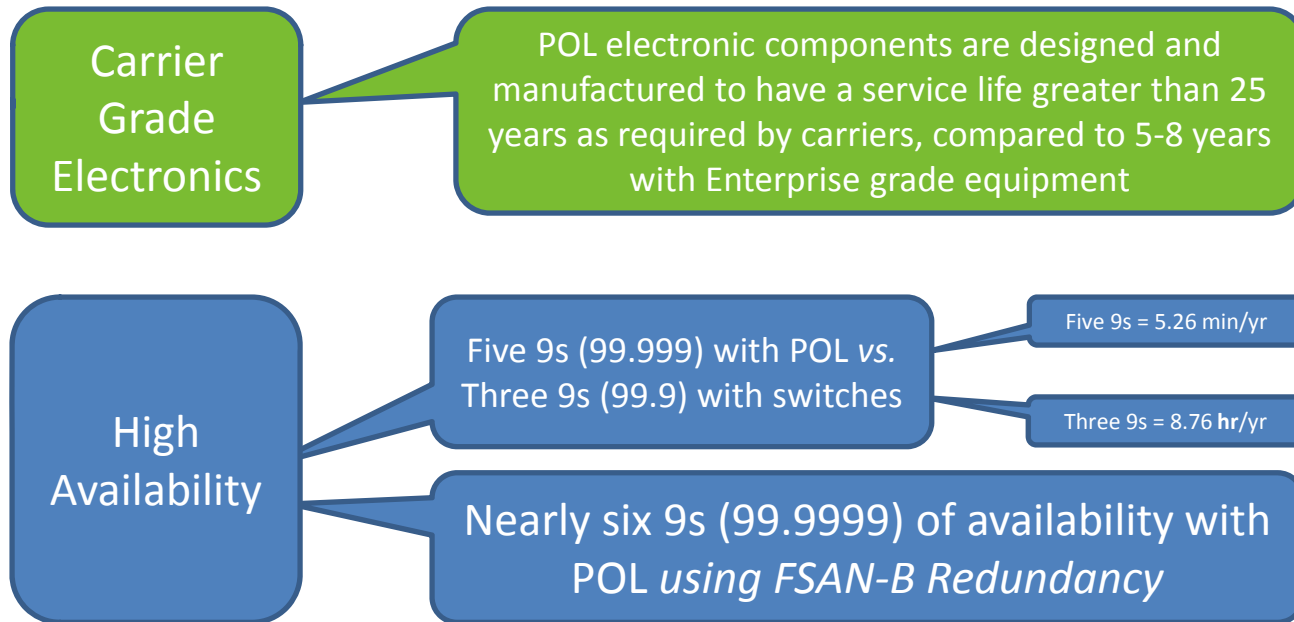



# What should you know?

## Similar

Standards Based

Local Area Network

Enterprise Management

Ethernet Frame Transport

NAC Auth. – VLANs – PoE  
802.1x – 802.1Q – 802.3at

## Different

Point to Multipoint

Multiple Services

Guaranteed Bandwidth

Single Strand of SM Fiber

No Access and Distribution

# Where did it come from?

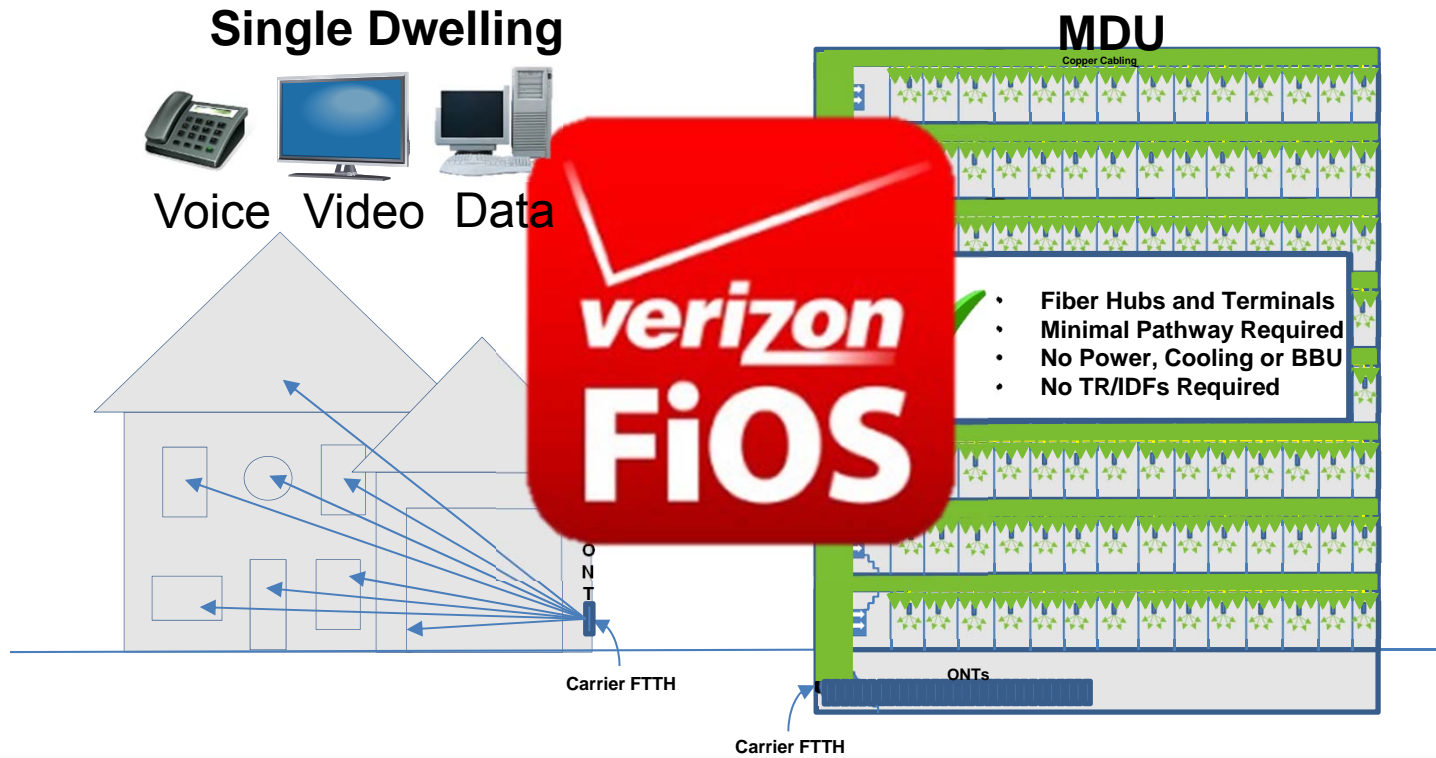

# What's the difference between a...

30 Story Apartment Building and a 30 Story Office Building



Furniture!

# Target POL users



Healthcare

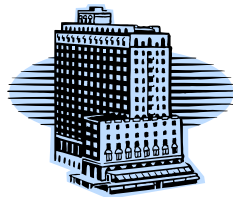

Hospitality



Education  
(K-12 and Higher Ed.)



Campuses



High Occupancy Buildings  
(Call Centers)



Multi-Tenant Units  
(Commercial and Residential)



Casinos



Government and Military



Sporting Venues

# Market Segment Adoption (Partial List)

## Government and Military

- Department of Energy
- Department of Defense
- Department Homeland Security
- Health & Human Services
- Intelligence Agencies
- NASA
- State Department
- US Air Force
- US Air Guard
- US Army
- US Army Reserves
- USDA Forest Service
- US Marine Corps
- US Forest Service

## Hospitality/Hotels/Resorts

- Marriott
- Mandarin
- Crown Plaza
- Buccament Bay Resort
- Ice Hotels
- Kittitian Hill Resort

## Business Services

- Canon
- Google International HQ Sunnyvale
- Getty Images London HQ
- Verizon Business Offices
- GlaxoSmithKline
- Shearman & Sterling
- NiSource
- Center for Excellence in Wireless & IT
- Advanced Energy Center
- Simmons Building for Physics & Geometry
- Motorola Solutions Sweden AB
- Deltek
- Miles & Stockbridge Law firm
- Telecommunications Industry Association

## MTU/MDU Residential and Commercial

- Empire State Building
- Dallas Fort Worth Airport
- Trump Tower Miami
- Trump Plaza NY
- Stuyvesant Town/Peter Cooper Village NY

## Financial

- Russell Investments (AU)
- SouthEast Bank

## Healthcare/Hospitals

- Erickson Living Retirement
- Pardubice Regional Hospital
- ArchCare/Cardinal Cooke Center
- Williamsburg Landing
- Camp Pendleton Hospital
- Western State Hospital
- Guthrie Corning NY Hospital

## Education/K-12/Universities/Colleges

- Virginia Tech
- Howard Community College
- Stony Brook State University
- University of Mary Washington
- Bridgepoint Education
- Dalhousie University
- Amherst College
- Chilliwack School District (BC)
- Washington State University
- American College of Radiology
- Orangeburg Public Schools
- San Diego Public Library
- Santa Fe Public Schools



## Example POL Implementation

*Global Fortune® 225 Company – Americas Headquarters Melville, NY USA*

### Project Overview:

- Approximately 1 million sq. ft. (main building and 2 parking garages)
  - Planned growth for another 200,000 sq. ft.
- 1,500 employees
  - Planned growth for another 750
- Nearly 12,000 GPON Ethernet ports

### Integrated Technologies over GPON:

- VoIP (PCs tethered through phone)
- Security
  - Access Control
  - Biometrics
  - Cameras (main building and parking)
  - Virtual turnstiles
  - Blue Phones in parking garage
- 480 WAPs
- Building automation
- Environmental controls
- IP Video content distribution
- Digital signage
- Point of Sale



Member Integration/Implementation

### Project Highlights

\$1 million in CAPEX savings

Approximately \$250,000/yr in energy savings



# San Diego Downtown Central Library

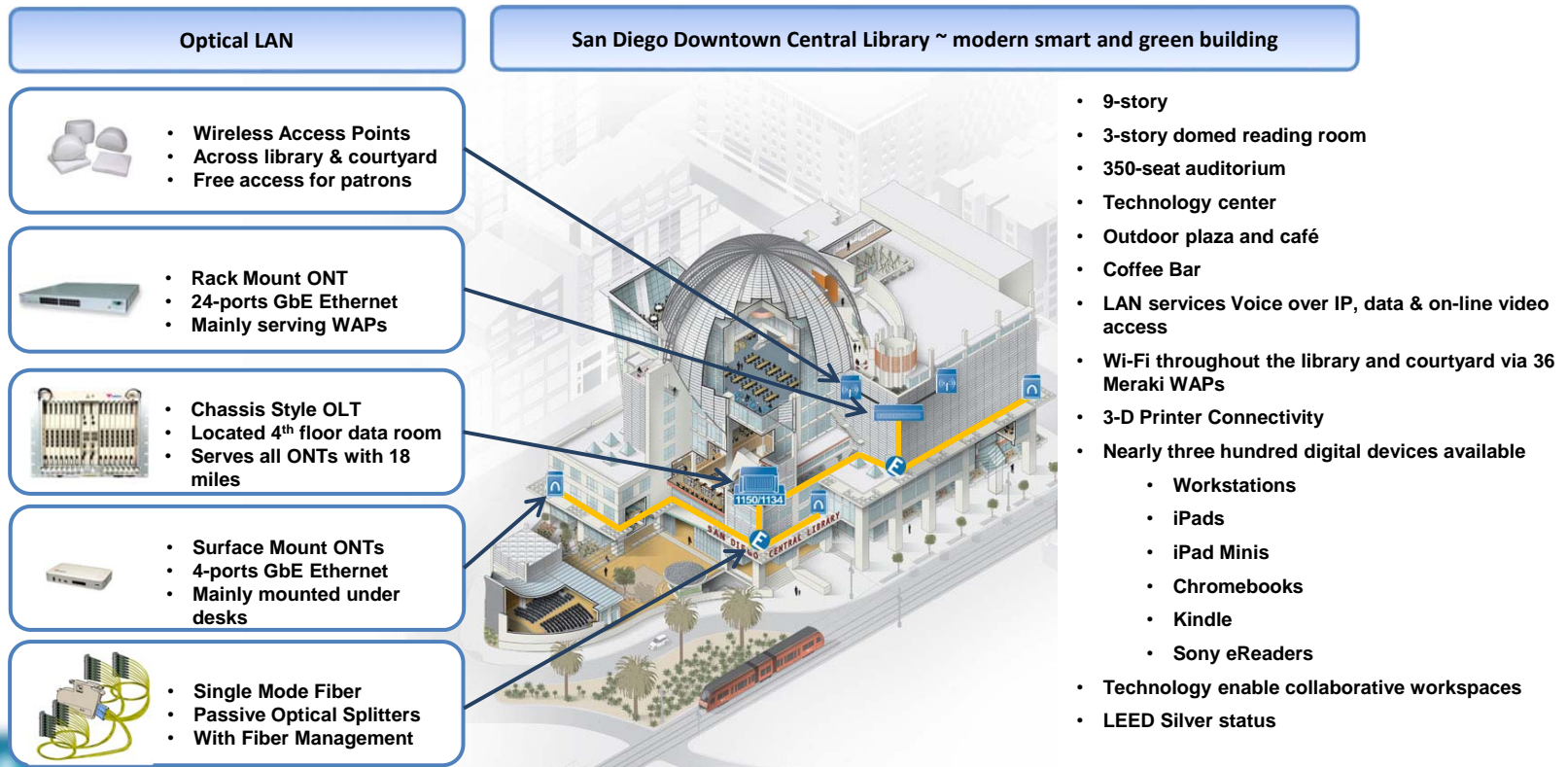

# Knowledge Check





**Passive Optical LAN is a standards based/recognized technology**

- ✓ A.True
- B.False

**Guaranteed bandwidth is possible with...**

- ✓ **A. Passive Optical LAN**
- B. Switch Based**
- C. Both A and B**

**POL supports 802.1Q VLANs**

- ✓ A.True
- B.False

**AES 128 Encryption is present in \_\_\_\_\_  
direction(s)**

**A. The upstream**

**✓ B. The downstream**

**C. Both upstream and  
downstream**

# Section 2 Agenda

- Verticals
- Bandwidth Requirements
- Dynamic Bandwidth Allocation
- Knowledge Check



# Education Vertical Market

- **K-12**
  - Tight budgets vs. increased demand
  - Space constraints and non-traditional TRs/IDFs
  - Aging architecture vs. modern technology
    - Mondo Pads
    - AMX SchoolView
    - Smart Boards
    - Central content
  
- **Post Secondary / Higher Education**
  - Higher bandwidth demand
  - Increased BYOD
  - Valuable space lost with traditional
  - Lost revenue and added costs
    - Inefficient use of bandwidth
    - Inefficient use of space
    - Service providers profit



# Hospitality Vertical Market

- **Hotels**

- Industry groups driving POL advanced technology
  - HTNG – Hotel Technology Next Generation
  - HFTP – Hospitality Financial & Technology Professionals
    - HITEC – Hospitality Industry Technology Exposition and Conference
- Higher port density in guest rooms and non administrative areas
  - Digital signage
  - Cameras
  - WAPs
  - IP card readers and locks
  - Four to eight data ports per guest room
- Scalable solution with extended reach
  - Resort properties
  - Shared plot properties (Fairfield Inn, Courtyard, and Residence Inn)
- Future proof cabling infrastructure



# Healthcare Vertical Market

- **Senior Living**

- Patient wandering – WAP monitoring
  - In residence
  - Anywhere on the property
- VoIP and Data needs in residence and administration
- Security and Digital Communication



- **Critical Care**

- Higher bandwidth demand
- Higher port counts in patient rooms, nurse stations, and operating rooms
- Building Automation and Intelligent Structures (converged networks)
  - Security
  - Monitoring
  - HVAC
  - Automated check-in / check out
  - Door sensors
- No EMI/RFI concerns or Tempest shielding needed with fiber
- Encrypted data pathways





# Large Enterprise / Financial Vertical Markets

- **Large Office Building**

- Movement toward all BYOD
- Converged networks (HVAC, Automation, Security, etc.)
- Pathway and space constraints
- Cost of traditional switch, cabling, and maintenance refresh
- Increased technology
  - Pervasive wireless
  - Everything headed IP



- **Financial (Banks and Trading Floors)**

- Higher bandwidth demand
- Increased security
- Increased port count
- Redundancy, diversity, and automatic failover (FSAN-B)
- Lost revenue and additional costs
  - Downtime (three 9s vs. five 9s)
  - Missed trades
  - Excess energy



# Federal, Local Municipal and Retail Markets

- **Federal**

- Security paramount
- Capex constrained budgets
- Older buildings do not have pathways and spaces for traditional upgrades
- Scalable solution for future expansion
- Special certification often required



- **Local Municipalities**

- Campuses likely: Connect multiple buildings without distance limitations
- Older buildings do not have pathways and spaces for traditional upgrades
- Scalable solution for future expansion



- **Retail**

- Digital signage
- Customer Interactive Experience (pricing, web details, ordering, price compare)
- Security, POS, multi-tenant service
- Location-based advertisement
- Bulk check-out



# Public Venue / Stadium Vertical Market

- Convention Centers
- Concert venues
- Sports stadiums
  
- Large expansive spaces – very long cable runs
- End points often time is a WAP
- Digital signage
- LARGE video screens common
- When in use → very high capacity and usage
- Guest experience important → QoS



# User Bandwidth Needs

YouTube



8 GB file  
(64 G bits)

10 Mb/s = 0.01 Gb/s

$$\frac{64 \text{ Gbit}}{0.01 \text{ Gbit/sec}} = 6,400 \text{ sec} = 1:46:40 !$$

(h:m:s)

208 Mb/s = 0.21 Gb/s

$$\frac{64 \text{ Gbit}}{0.21 \text{ Gbit/sec}} = 305 \text{ sec} = 5:05$$

1 Gb/s

$$\frac{64 \text{ Gbit}}{1 \text{ Gbit/sec}} = 64 \text{ sec} = 1:04$$

- Does everyone need 1 Gb/s continuously, all day, every day?
- For most users today – NO!

## You need how many “Gigs”?

Common LAN Services	Typical Required Bandwidth
Email and Web Browsing	500Kbps
Voice over IP	110Kbps
Cloud-based Services (data storage, enterprise s/w, collaboration, etc...) Low	50Kbps
Cloud-based Services (data storage, enterprise s/w, collaboration, etc...) High	100Kbps
Wireless Access Point Capacity (IEEE 802.11 a/b/g/n)	24Mbps
Wireless Access Point High Capacity (IEEE 802.11 ac/ad, dual radio)	300Mbps
IP Video Surveillance Standard Definition (MPEG4/H.264)	2Mbps
IP Video Surveillance High Definition (MPEG4/H.264)	6Mbps
IP Video Conferencing / Telepresence (720p-Good, includes primary/auxiliary)	2Mbps
IP Video Conferencing / Telepresence (1080p-Best, includes primary/auxiliary)	15Mbps

**Gartner 2013 Estimates of Bandwidth needs through 2017 shows Super Users with a maximum requirement of sub-7Mbps**

## How much bandwidth is really needed?

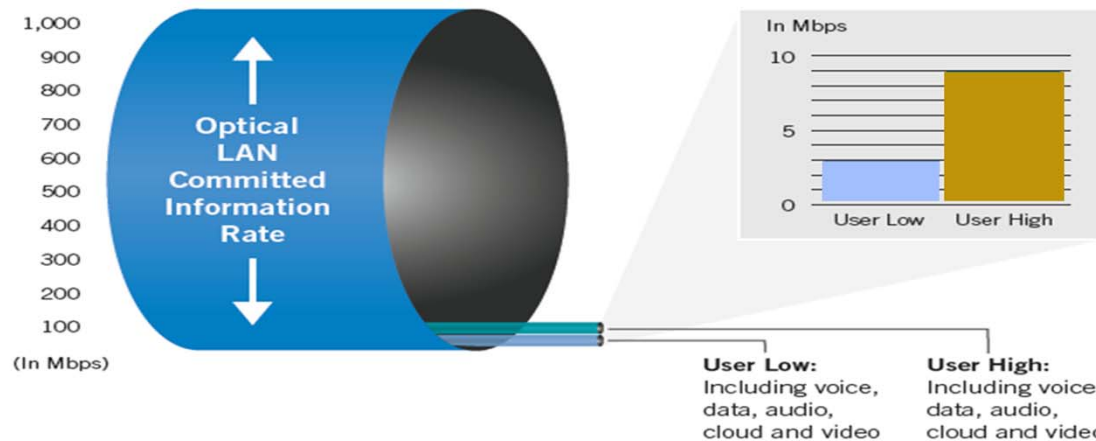

### Optical LAN bandwidth compared to Peak bandwidth per User in 2017

- Blue represents symmetrical 1 gigabit bandwidth available at every ONT port
- Light Blue and Green represents Gartner Low User and High User bandwidth required 2017

# Bandwidth Capacity vs. Bandwidth Traffic



# In traditional networks...



Listen up!!! I have 10Gig OM4 Fiber in my Backbone and 10Gig Cat6 Copper in my Horizontal, so when I put in a 10Gig switch it won't have any resistance and I will get a Gig to the desk and be future proof.

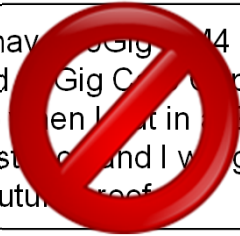

  
Backbone OM3/4 (10Gb/s)



  
Horizontal CAT6A Cu (10Gb/s)

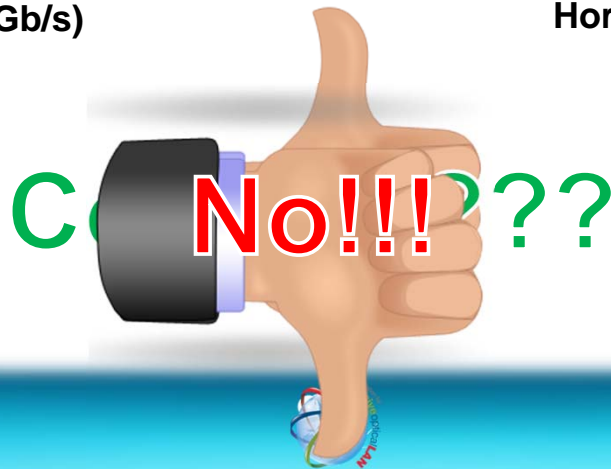



# It is not a matter of resistance...

48 Port Gigabit Ethernet Switch

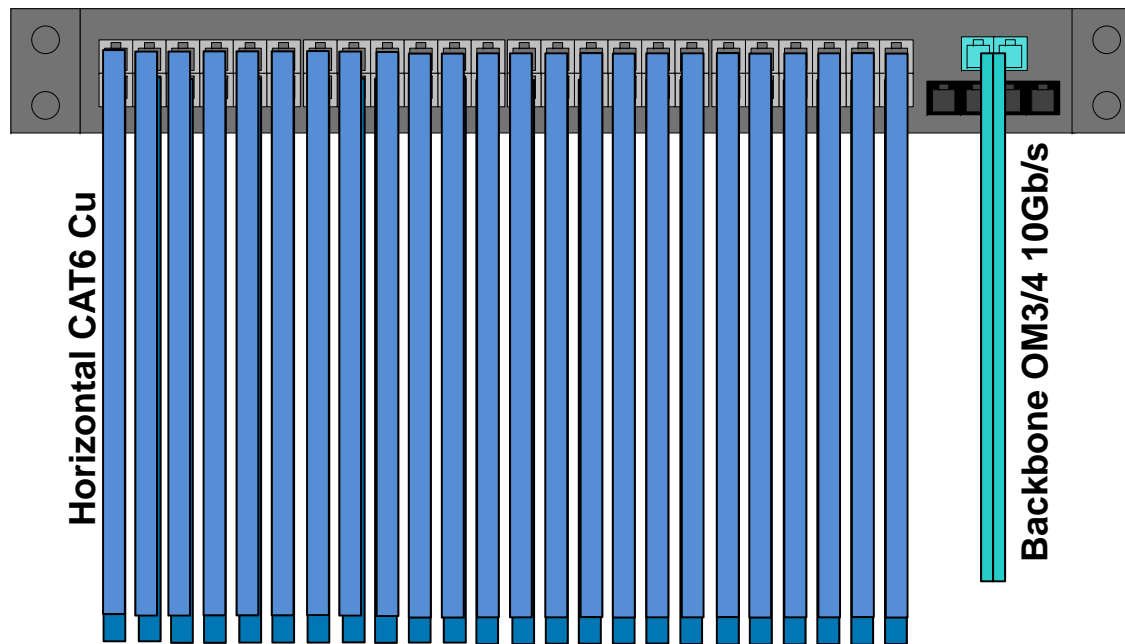

**208 Mb/s**

Does your IP phone need 208Mb/s?



# Switch Data vs. Dynamic Bandwidth Allocation

24 Port 10/100 Ethernet Switch

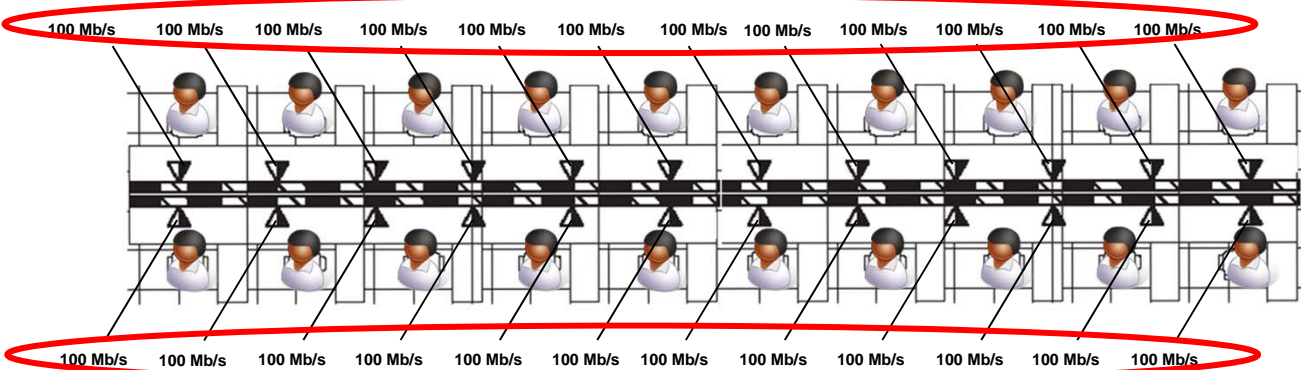

Let's Most users use 0Mb/s over 98% of the workday  
 When all others are using 0Mb/s for are pig on the office and a desk  
 Every data port still has a 100Mb/s connection  
 Every download is possible, they are limited to 100Mb/s.

- A minimum of 100Mb/s
- A maximum of 100Mb/s



# Switch Data vs. Dynamic Bandwidth Allocation

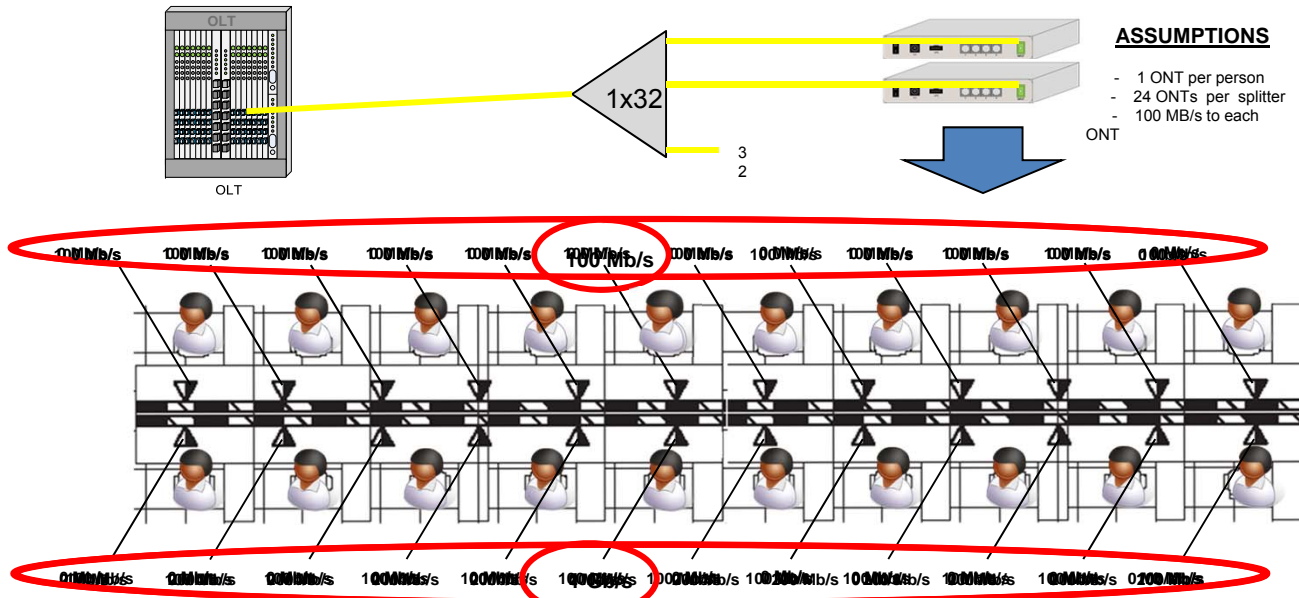

Whereas users are always available, most users use 100 Mb/s over 98% of the workday. When a user requires more bandwidth, the network must dynamically allocate bandwidth. Every user has to download data, which may burst to 1 Gb/s. This is why dynamic bandwidth allocation is required.

- A minimum of 100 Mb/s
- A maximum of 1 Gb/s

# VLANS and Committed /Burst Rates

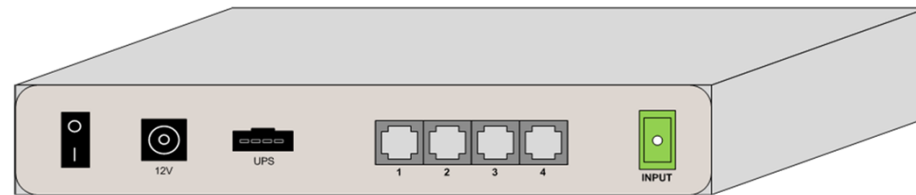

# Knowledge Check



**Gigabit switches provide 1Gb/s connections to each WAO**

A.True

✓ B.False

**Most users consume bandwidth all day long**

A. True

✓ B. False

**This technology uses Dynamic Bandwidth Allocation**

**A. Switch Based**

**✓ B. Passive Optical LAN**



**Most users require a sustained GbE connection**

A. True

✓ B. False

## Which vertical markets are suitable for POL?

- A. Education
- B. Hospitality
- C. Healthcare
- D. Public venues
- E. Stadiums
- F. Financial
- G. Large offices
- H. Municipal
- I. Retail
- J. None
- K. All except F.
- L. All



**Most users consume data at a constant bit-rate all day long.**

A. True

✓ B. False

# Questions?

Passive Optical LAN: 101

Tom Ruvarac

APOLAN

# Passive Optical LAN:102



Tom Ruvarac

Association for Passive Optical LAN

BICSI FALL



BicSI

# Section 3 Agenda

- Layout
- Primary Components
- Design Tips
- Support and Compatibility
- Knowledge Check
- Lunch

# Traditional LAN vs. POL

## Traditional LAN

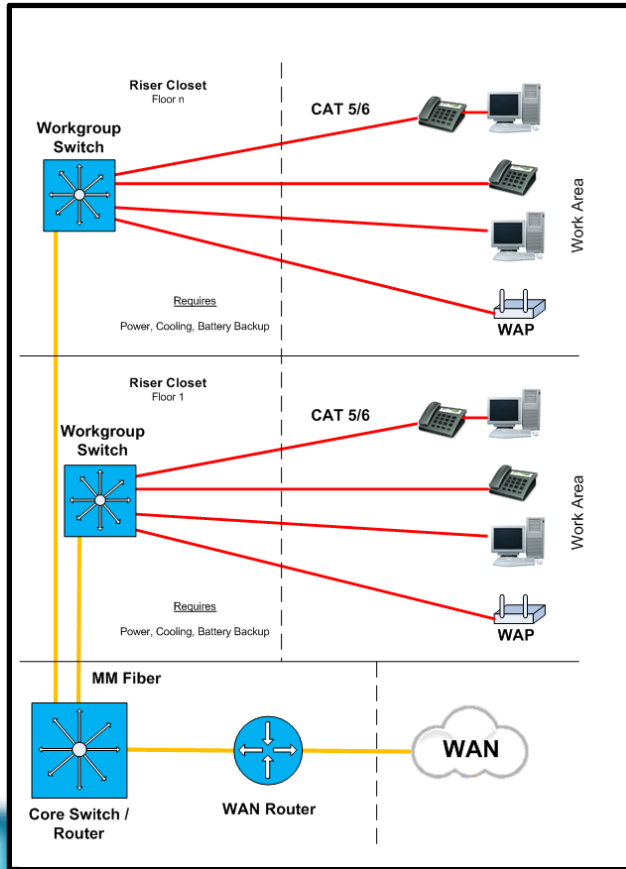

## Passive Optical LAN

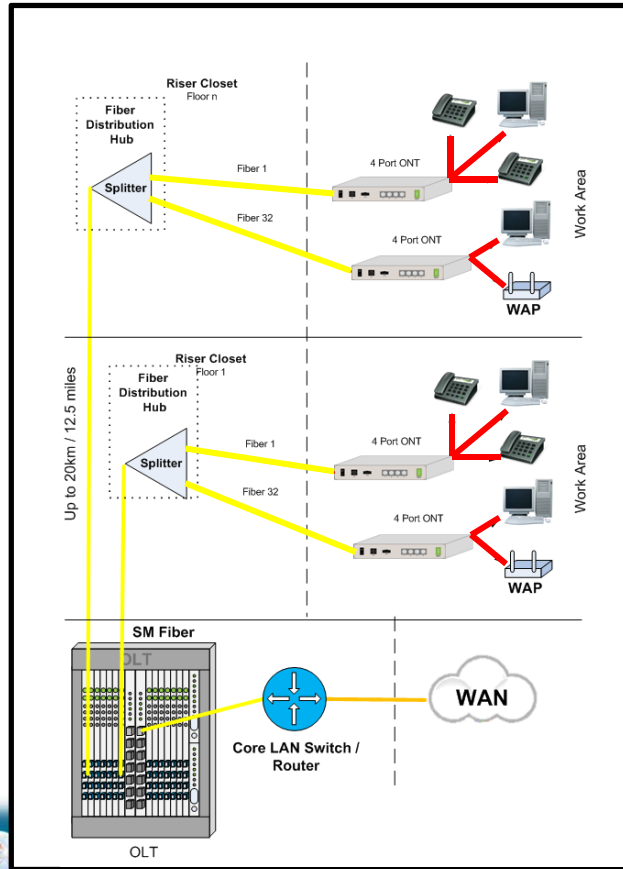

# POL in a Campus

**Building #1**

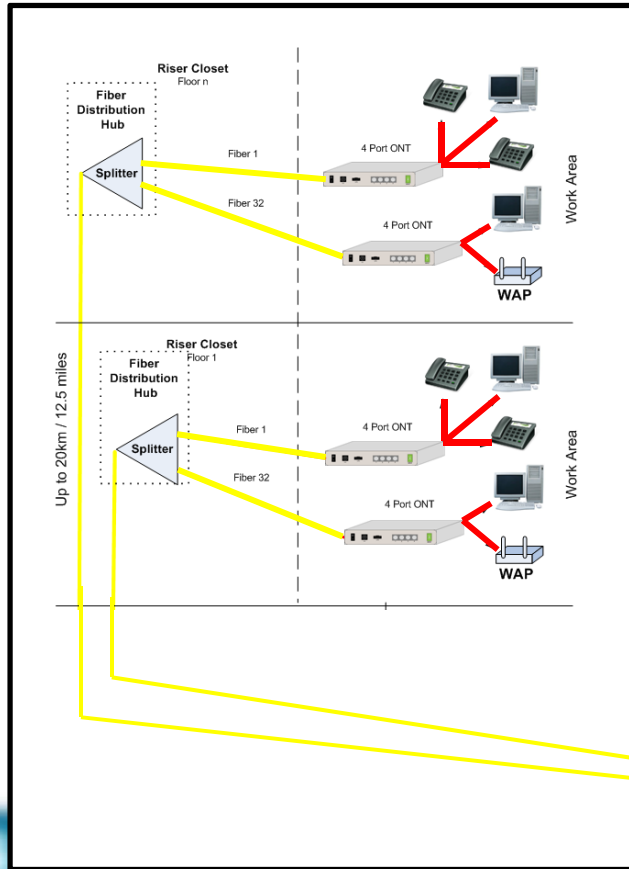

**Building #2**

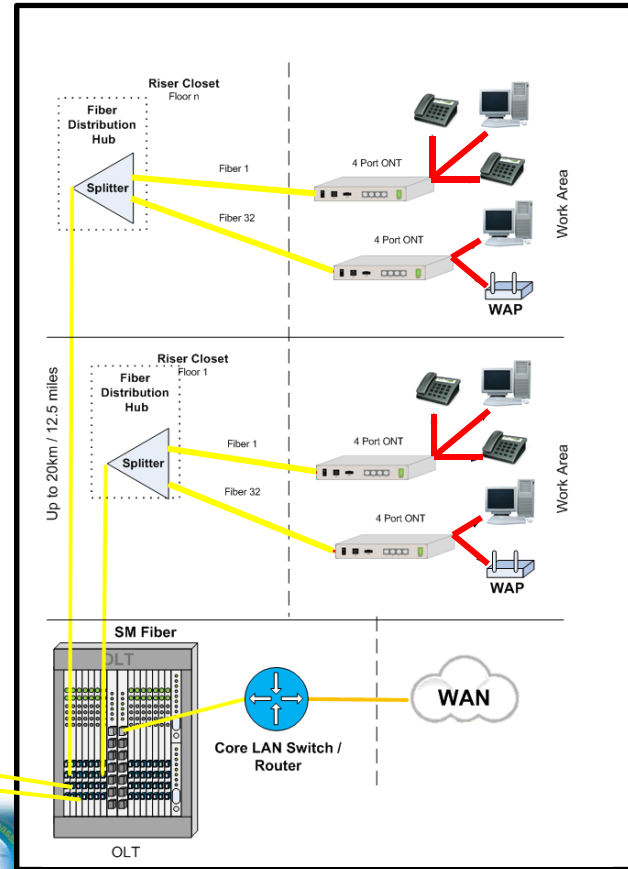



# POL Network Architecture

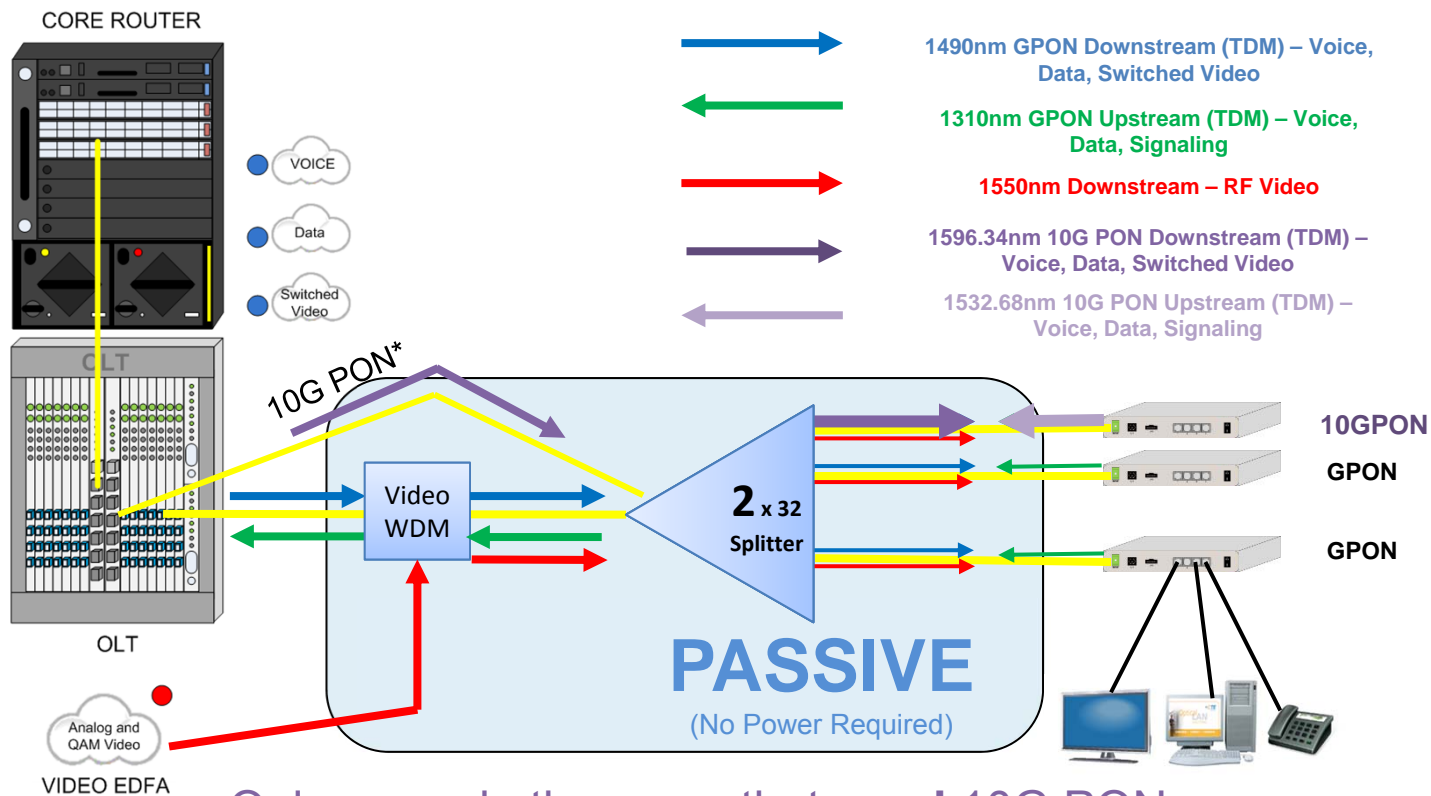

Only upgrade the users that need 10G PON

\* 10G Methods vary by electronics vendor

# The Migration to 10G PON (NG-PON1)

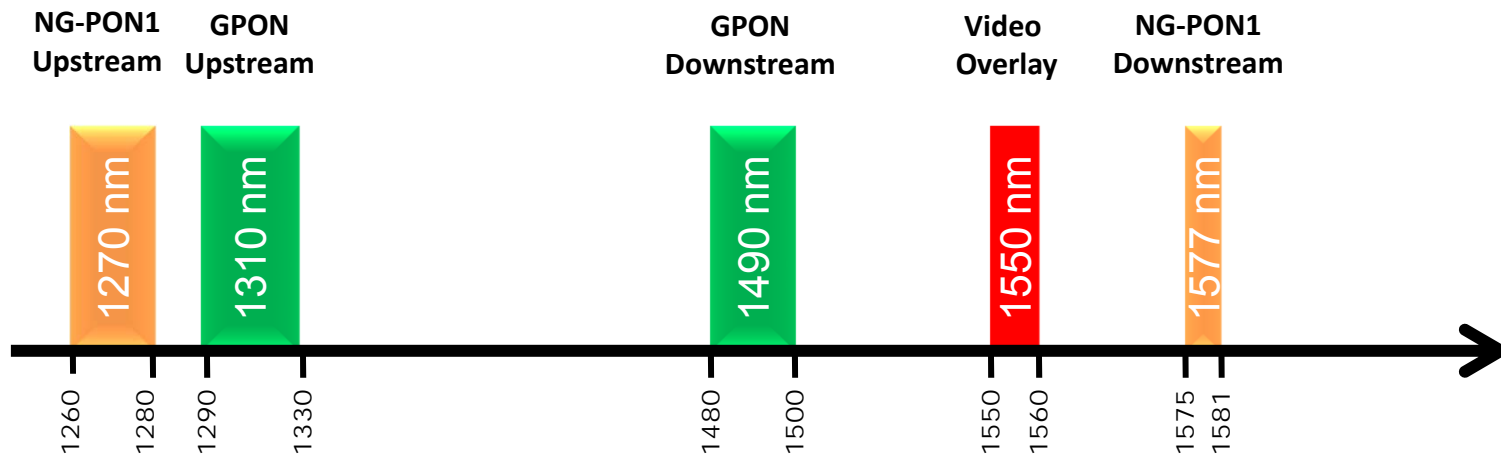

The cabling infrastructure stays the same and only the users that need it are upgraded.

# The Migration to 40G PON (NG-PON2)

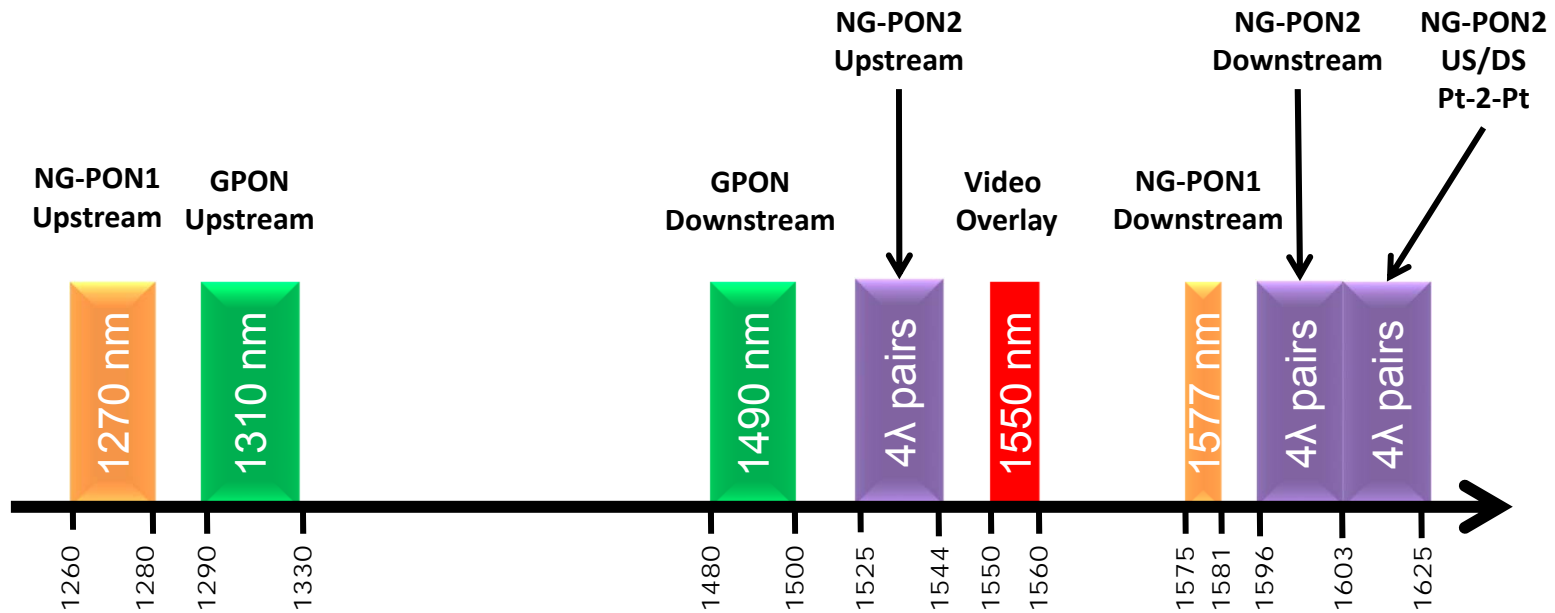

The cabling infrastructure stays the same and only the users that need it are upgraded.

PON Name	Version	DOWN (Gbps)	UP (Gbps)	Industry Standard
G-PON		2.5	1.25	ITU G.984
NG-PON1	XG-PON	10	2.5	ITU G.987
	XGS-PON	10	10	ITU G.9807
NG-PON2		40	40	ITU G.989

# The Primary Components

## Optical Line Terminal (OLT)

- -48VDC Carrier Grade Chassis
- After Layer 3
- Up to 14 Line cards
- Typically 4 singlemode output ports per card
  - = 56 Outputs per chassis
  - = 1792 ONTs (1x32 splitters)
  - = 7168 Ethernet Ports (ONT has 4 copper output ports)

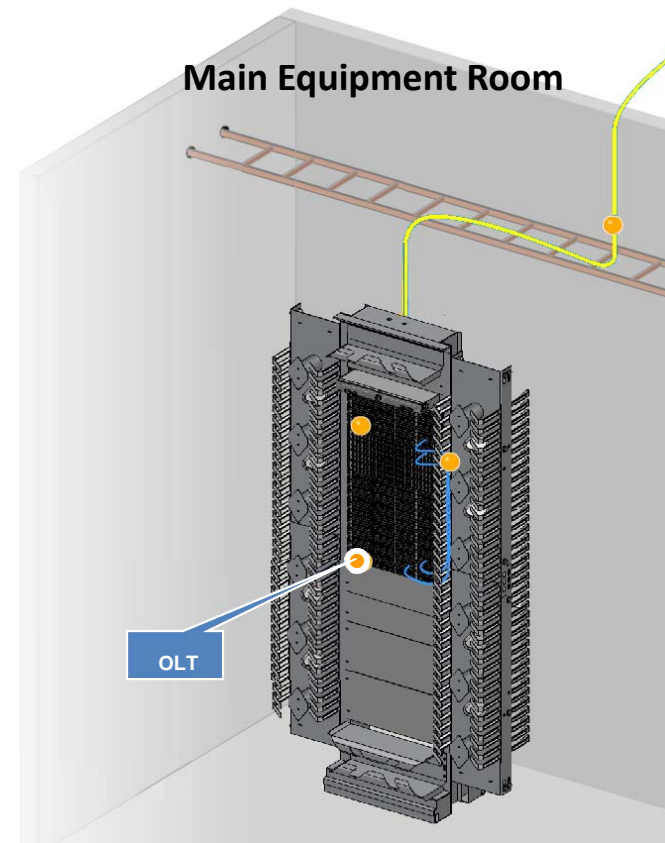
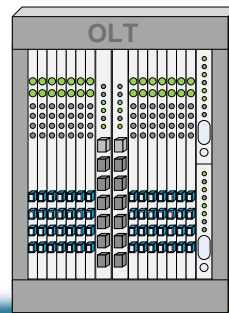

# POL Primary Components

## ONT – Optical Network Terminal a.k.a. “POL Media Adapter”

- Active equipment provided by electronics manufacturers.
- Located near the user or device
- Typically 4-8 RJ45 (10/100/1000) outputs with optional POE
- Up to 60W of available POE (vendor specific)
- Standard HVAC is adequate → some in a riser
- Optional internal or external battery back-up
- POTS and COAX ports available
- Establishes and maintains secure AES 128 Encryption
- Supports multiple VLANs on each port

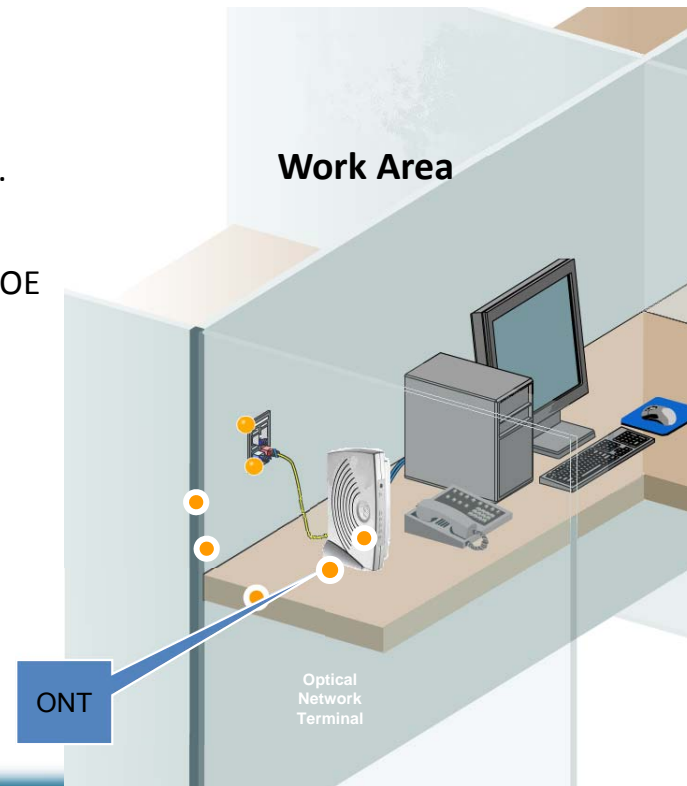
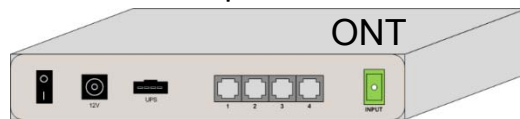

# The Primary Components

## Optical Splitters



### Available Splits

1x2

1x4

1x8

1x16

1x32

2x4

2x8

2x16

2x32

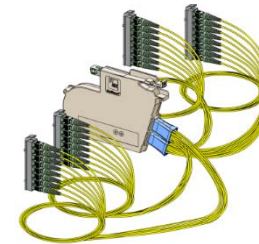

Traditional 1U Rack-Mount Splitter



# The Primary Components

## ONT – Optical Network Terminal

- Active equipment provided by electronics manufacturers.
- Located near the user or device
- Typically 4 RJ45 (10/100/1000) outputs with optional POE
- Up to 60W of available POE (vendor specific)
- Standard HVAC is adequate
- Optional internal or external battery back-up
- POTS and COAX ports available
- Establishes and maintains secure AES 128 Encryption
- Supports multiple VLANs on each port

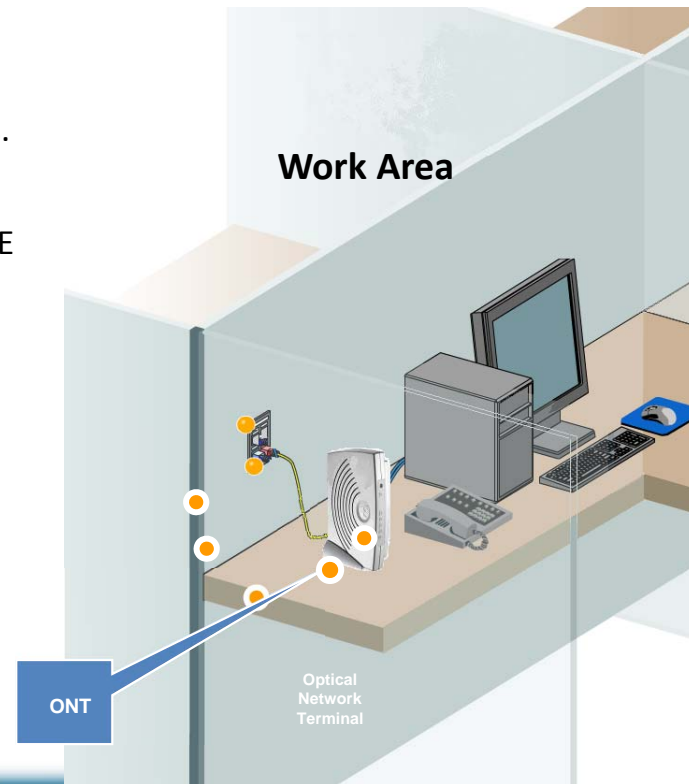

# ONT User Sharing

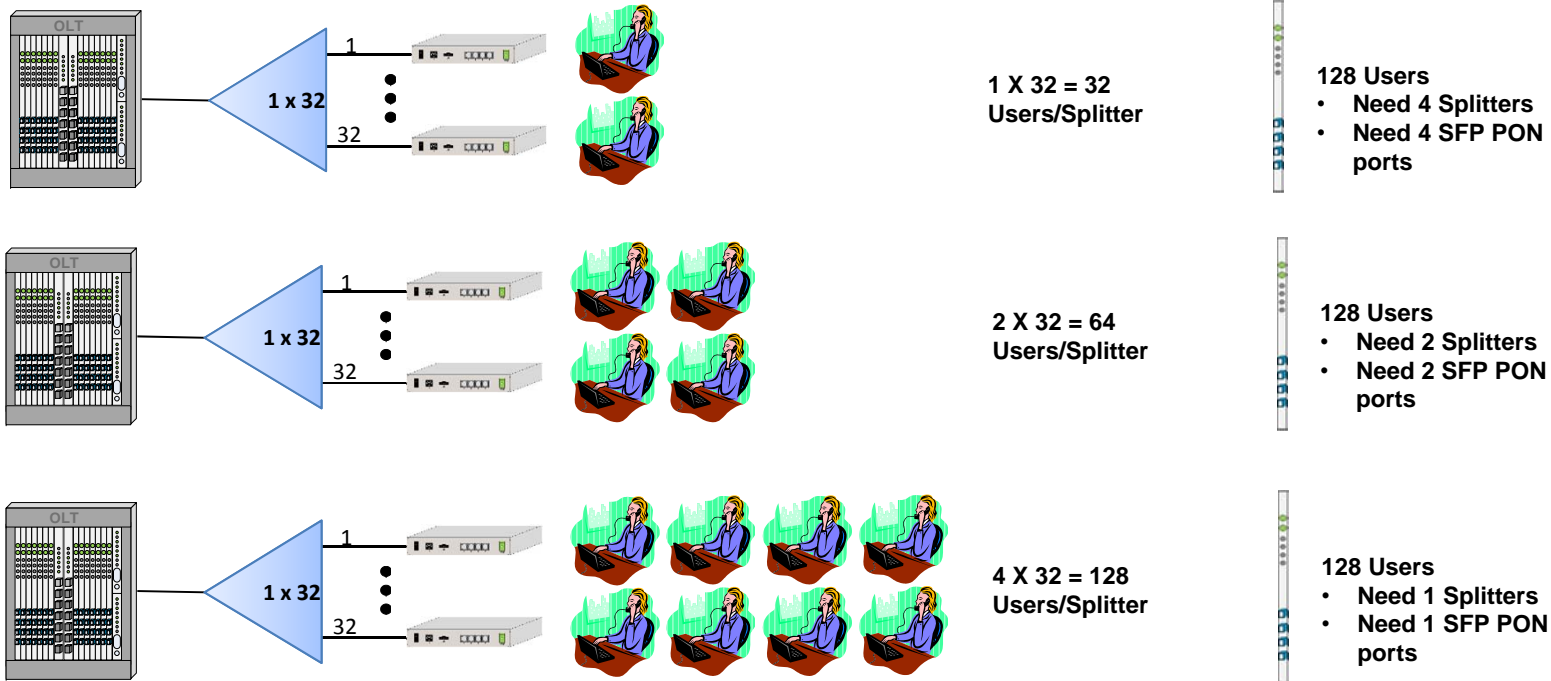

Change number of users per ONT → changes number of splitters and number of PON ports.



# POL Distance and Signal Level

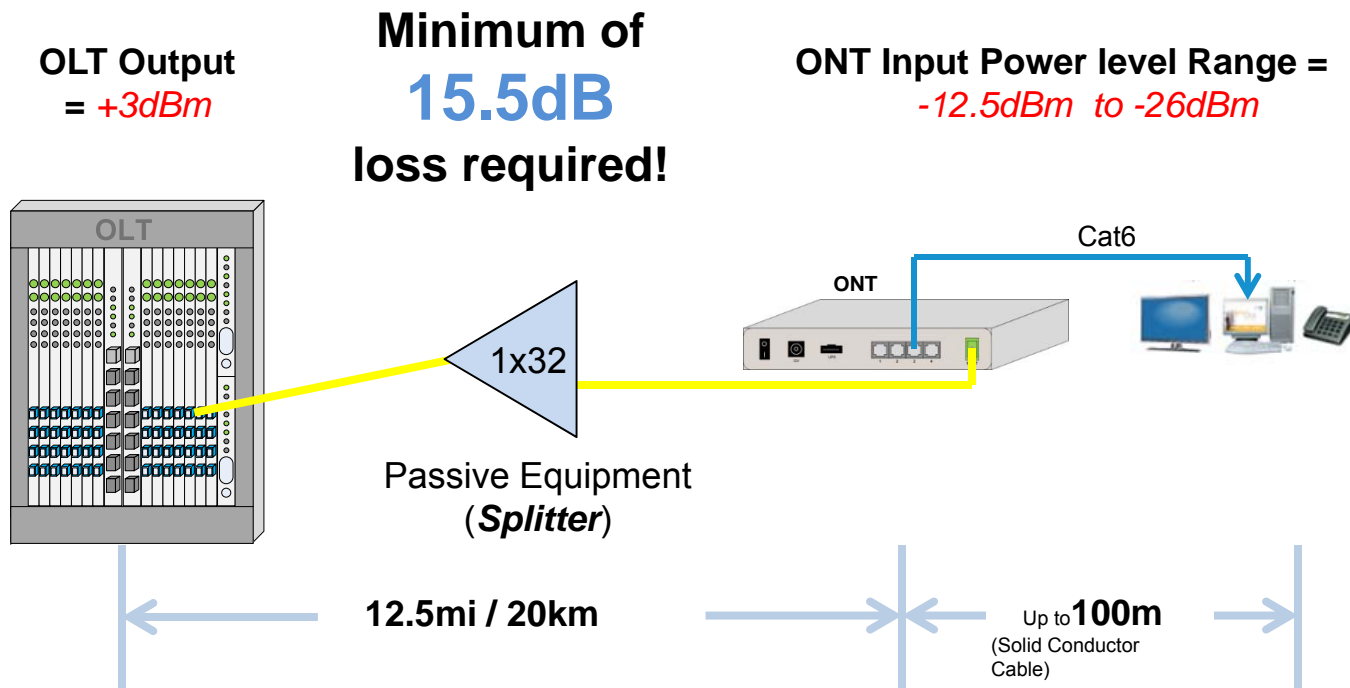

# Cascade Splitting Loss

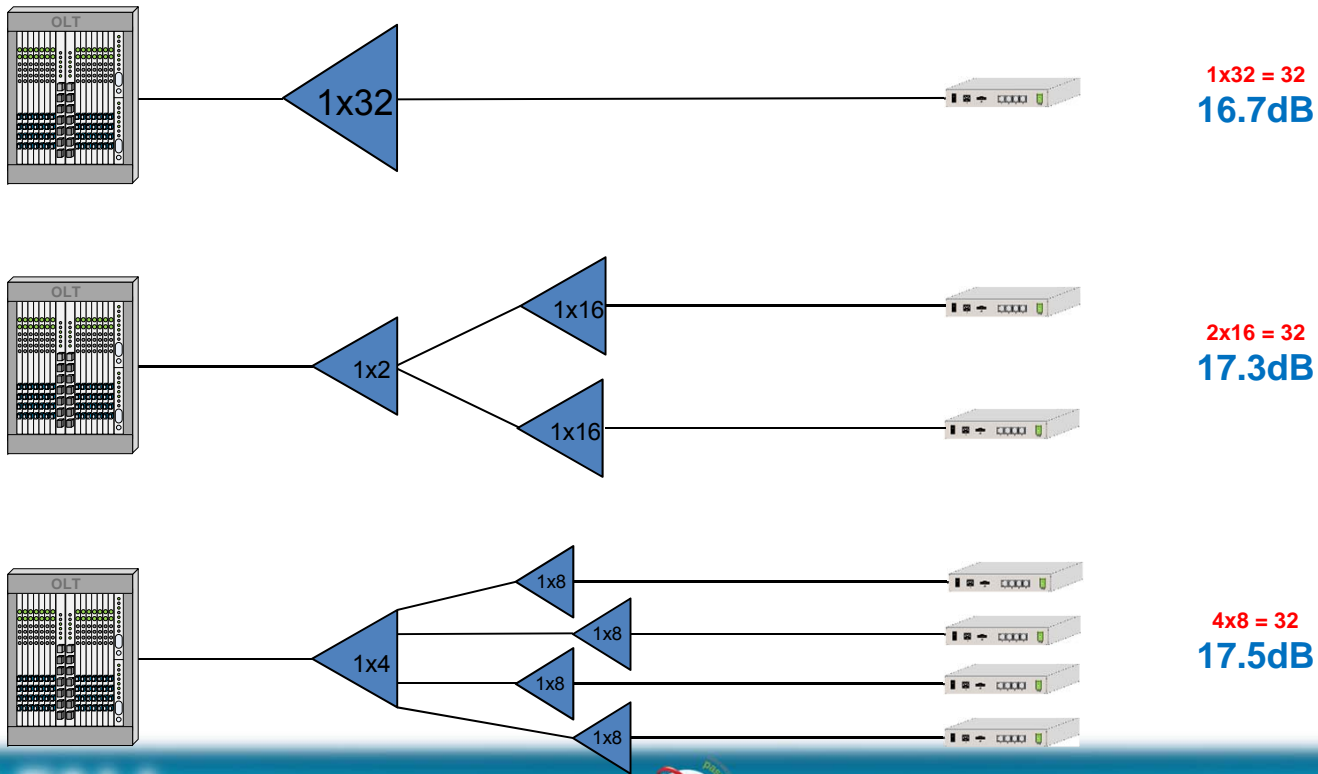

# Split Ratios Do NOT “Change” Bandwidth

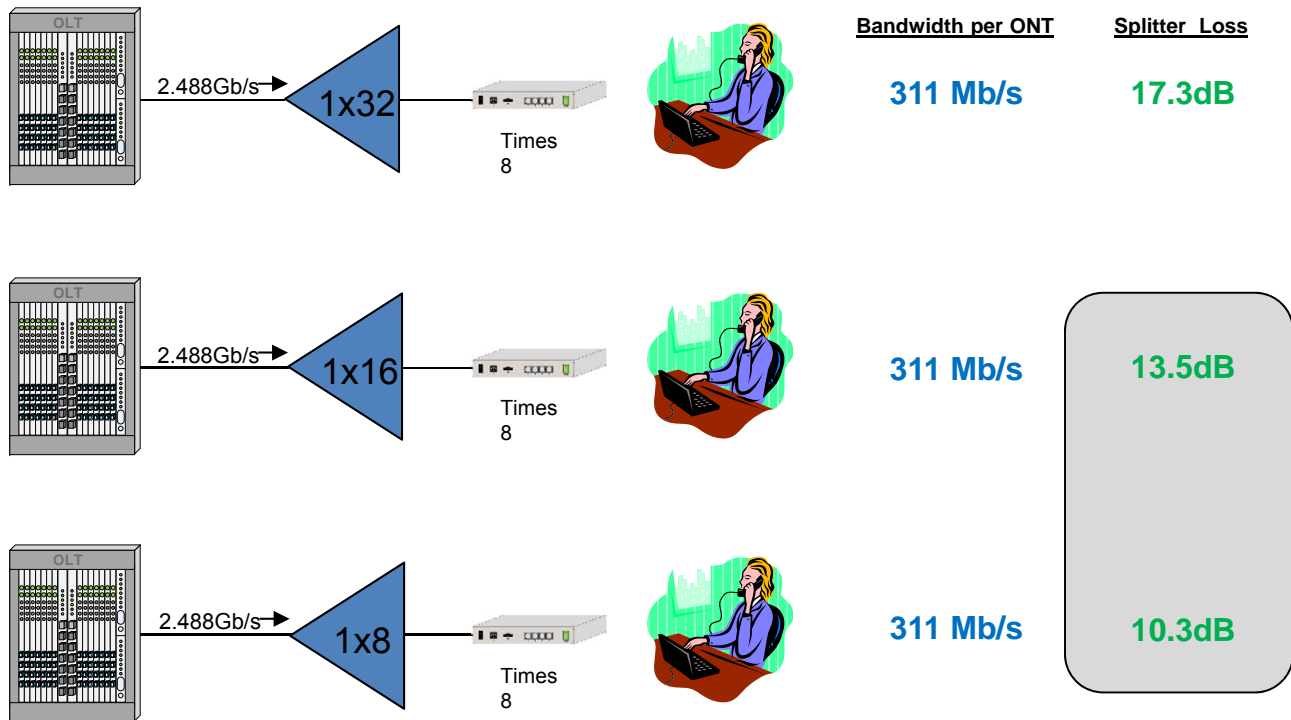

# Type B (FSAN-B) Redundancy

If any interruption is detected on the primary path (OLT to ONT), the OLT will switch to the redundant path instantaneously.

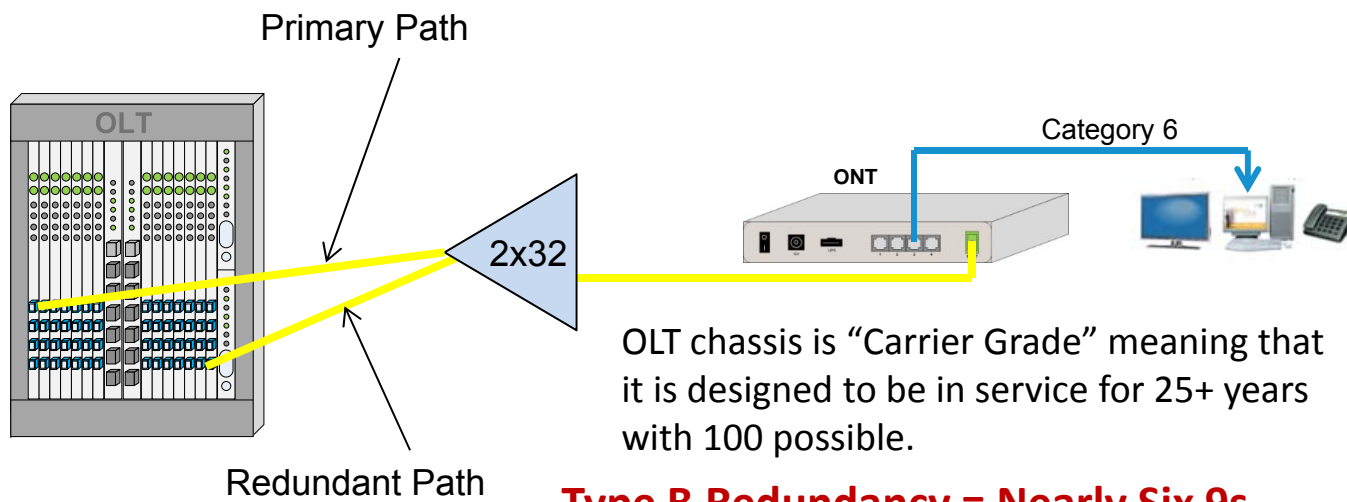

**Type B Redundancy = Nearly Six 9s**

# Example Layout of Type B (FSAN-B) Redundancy

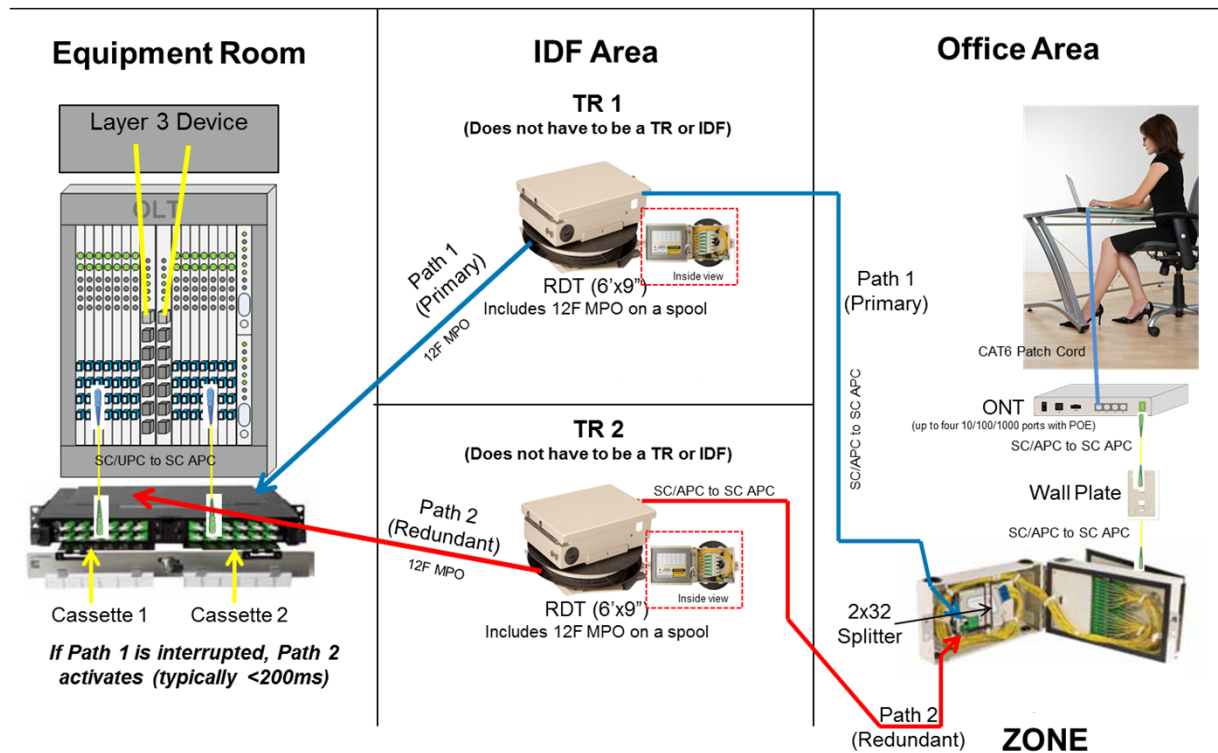

# IP/Ethernet Protocol Support

Network Integration	Service Delivery	Monitoring / Management
Multiple 1G and 10G Ethernet Uplinks	802.1p: Class of Service	SNMP v1, v2, v3
IEEE 802.3ad Link Aggregation Control Protocol (LACP)	IP differentiated services code point (DSCP)	CLI Console Port
IEEE 802.1Q VLAN Encapsulation	Quality of Service: Per-VLAN, Per-Port, Per-Service queuing / scheduling *	Remote Monitoring (RMON) software agent
IEEE 802.1w Rapid Spanning Tree (RSTP)	Sophisticated QoS and Traffic Management	RMON I & II
IEEE 802.1s Multiple Spanning Tree (MSTP)	Eight Queues per VLAN	Enhanced SNMP MIB support
Virtual Router-to-Router Redundancy (VRRP)	Policing, Scheduling, Shaping per Queue	RFC 1213-MIB (MIB II)
IPv4 / IPv6	Congestion and Flow Control	Extended MIB support
IGMPv2 / IGMPv3	Hardware Based ACLs: L2, L3, L4	Network Timing Protocol (NTP)
Network Access Control (NAC)	Hardware Based Multicast Management	RADIUS based authentication
IEEE 802.1x (Port-based Authentication)	IEEE 802.3af, 802.3at (PoE)	SSH v1, v2
Dynamic Host Control Protocol (DHCP)	Link Layer Discovery Protocol (LLDP)	VMWare Support for EMS
DHCP Snooping and Option 82 insertion		OLT SysLog support (2014)
Port Security, Sticky MACs		Y.1371 (2014)
RFC-2267 (Denial of Service)		802.1ag Fault Detection (2014)
Traffic Storm Control		
Bridge Protocol Data Unit (BPDU) Guard		

*This represents a partial list of supported IEEE and IP/Ethernet protocols supported by POL vendors.*

**Be cautious and seek an expert – not all equipment will support all protocols.**



# Knowledge Check



**Upstream (ONT to OLT) analog video utilizes which wavelength?**

A. 1550nm

B. 1490nm

C. 1310nm

D. 1625nm

✓ E. None



**A cascaded 1x4 + 1x16 split is a good practice?**

A.True

✓ B.False

**GPON bandwidth can be increased by using a lower split ratio**

A.True

✓ B.False

**The minimum loss required between the OLT and ONT is...**

A. 13.5dB

B. 10.7dB

C. 15.5dB

D. 17.2dB

E. None of these

**PoE in a POL is administered at the...**

A.OLT

✓ B.ONT

C.Injector

D.PoE is not possible

# 60 Minute Lunch Break



**Please respect others and return on time.**

# Section 4 Agenda

- Savings
- LEED and Environmental Benefits
- Largest POL deployment in the world
- Knowledge Check
- 15 Minute Break

## *Savings*



## POL: Total Cost of Ownership Savings

Expense	250 Users	500 Users	1000 Users	Campus 5000 Users	Campus 10,000 Users
TCO	32%	46%	57%	68%	68%
CapEx	31%	41%	48%	55%	55%
OpEx	40%	50%	65%	70%	70%
• Power	48%	61%	68%	75%	75%
• Cooling	48%	61%	68%	75%	75%

Bigger \$\$ \*AND\* Bigger Percentages



# POL: Power Consumption Comparison

**Regional Medical Center  
4000 drops**

Price per kw hour	\$0.082	W/HR	Annual \$
Total POL Budget		14,050	\$10,081
Total Traditional Budget		37,171	\$26,670
Difference		(23,121)	(\$16,589)
Total Savings Percentage		-62.20%	

Traditional LAN				
Main Distribution Frame				
Description	Quantity	Rated Power	Total Power	Notes
Cisco WS-C3750X-48P-S(715W)	7	134	937	
UPS	1	937	187	UPS overhead
HVAC	1	1,125	1,350	Draw to cool UPS & Cisco *1.2
<b>Total</b>			<b>2,474</b>	
Intermediate Distribution Frames				
Description	Quantity	Rated Power	Total Power	Notes
Cisco WS-C3750X-48P-S(715W)	96	134	12,854	
UPS	1	12,854	2,571	UPS overhead
HVAC	1	15,425	18,510	Draw to cool UPS & Cisco *1.2
<b>Total</b>			<b>33,936</b>	
Desktop/Work Area				
Description	Quantity	Rated Power	Total Power	Notes
N/A				
<b>Total</b>			<b>0</b>	
Power over Ethernet				
Description	Quantity	Attenuation	Total Power	Notes
Copper drops	1,463			
Average length of drop	200			
Total feet	292,600	0.0026	761	Total loss via PoE
<b>Total</b>			<b>761</b>	

Passive Optical LAN				
Main Distribution Frame				
Description	Quantity	Rated Power	Total Power	Notes
AXS1800	2	516	1,032	2-SW, 2-SYS, 8-PON
UPS	1	1,032	206	UPS overhead
HVAC	1	1,238	1,486	Draw to cool UPS & AXS *1.2
<b>Total</b>			<b>2,724</b>	
Intermediate Distribution Frames				
Description	Quantity	Rated Power	Total Power	Notes
N/A	N/A	N/A	N/A	
<b>Total</b>			<b>0</b>	
Desktop/Work Area				
Description	Quantity	Rated Power	Total Power	Notes
WT21004		1,255	9	11,295 Admin areas
<b>Total</b>			<b>11,295</b>	
Power over Ethernet				
Description	Quantity	Attenuation	Total Power	Notes
Copper drops	1,463			
Average length of drop	8			
Total feet	11,704	0.0026	30	Total loss via PoE
<b>Total</b>			<b>30</b>	



## ***Potential\* LEED Credits***

- Energy and Atmosphere Credit 1 (1-3 pts).
  - Reduction in TRs, HVAC equipment, switch equipment, UPS, lighting and other energy needs.
  - The PON system helps the overall efficiency of the energy systems.
- Innovation in Design Credit 1 (1-4 pts).
  - The PON system utilizes less equipment, resulting in less raw materials, less garbage, less transportation and reduced time for implementation and commissioning.
  - In addition, utilizing a fiber system ensures the life of the system extends beyond the life of a conventional “switched” system.



\*not guaranteed or implied

## “Eco-Friendly”

- **Reduced Power Requirements**
  - Savings between 40% to 60%
- **Reduced HVAC Requirement**
  - A Fortune 500 company saved about \$450K on the Power distribution network (HVAC, backup etc) for a building project with 2000 Ethernet ports
- **Reduction in Non-renewable materials**
  - Reduction of up to 8000 pounds of plastic and copper versus a Cat 6 install for building of 4000 Ethernet ports
- **Floor Space Savings**
  - Traditional layer-2 solutions are bound by the 300ft Ethernet limitation
- **Fire Load Savings**
  - Savings in Sprinkler Systems
  - Fire Load and ceiling space savings



### Green Benefits

- Reduction in power consumption
- Reduction in non-renewable materials
- Ceiling space and fire load savings
- Reduction in cabling costs
- Floor space savings

# Cabling Comparison

Riser Rated Cables	Reduced Bend Radius Single-Mode	Category 5e UTP	Category 6a UTP
<b>10G Distance</b>	40km	45m	100m
<b>Cable OD</b>	3mm	5.7mm	7.5mm
<b>Weight</b>	4lb / 1000'	22lb / 1000'	39lb / 1000'
<b>Minimum Bend Radius</b>	5mm	22.8mm	30mm
<b>Tensile Strength</b>	48lbf	25lbf	25lbf
<b>Cost</b>	Low	Medium	High

## ***Largest Enterprise POL Deployment***

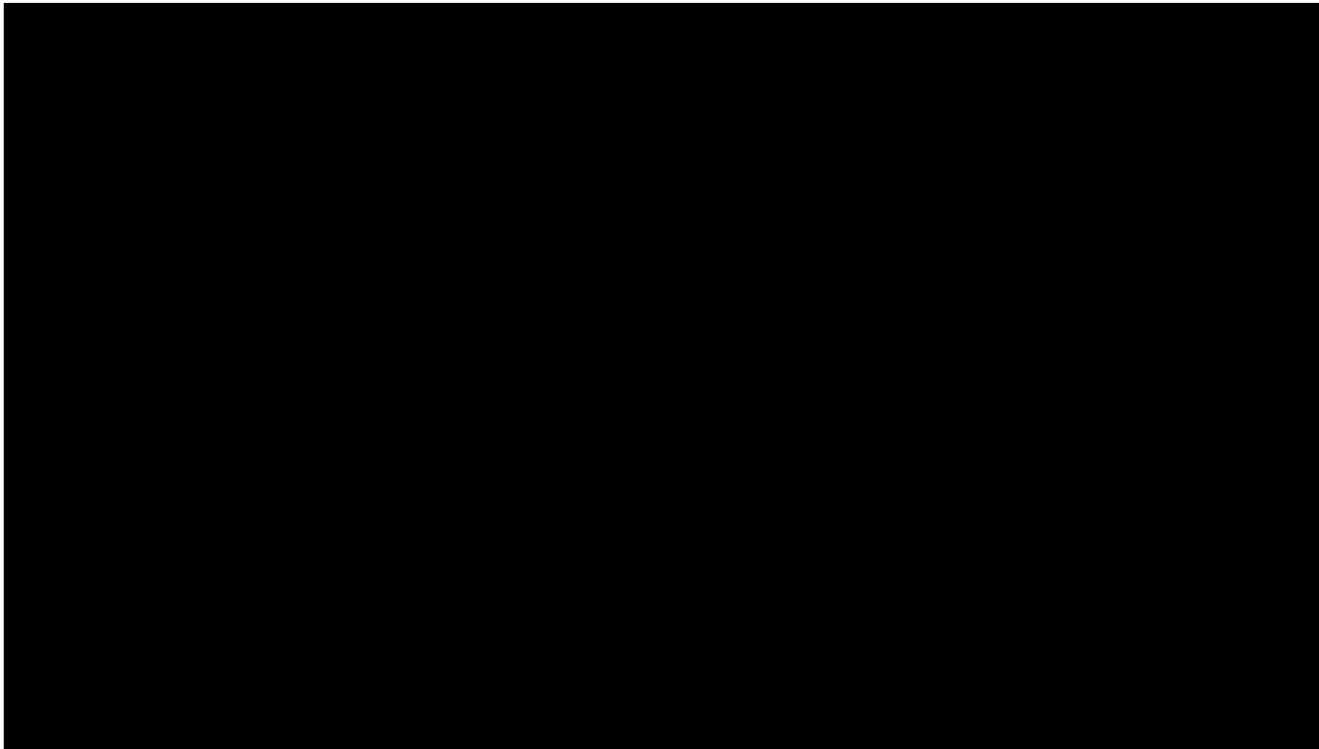

# Knowledge Check



## Which of these are a benefit of POL?

- A. Reduction in power
- B. Reduction of fire load
- C. Reduction of non-renewable materials
- ✓ D. All of these are benefits

## LEED Credits are

- ✓ A. Possible with POL
- B. Automatic with POL
- C. Guaranteed with POL
- D. Not Possible with POL

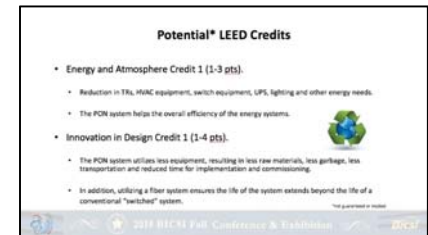



**So far, my knowledge depth of Passive Optical LAN increased so far today by...**

A. A little

B. A lot

C. What is Passive Optical LAN?

D. None

# Questions?

Passive Optical LAN: 102

Tom Ruvarac

Association for Passive Optical LAN

BICSI FALL  
CONFERENCE & EXHIBITION



BicSI

# 15 Minute Break



**Please respect others and return on time.**

# Introduction to POL Components

Matt Miller

Associate Vice President, AECOM



# Agenda

- Components
  - OLT
  - ONT
  - Video
  - DC Power
- Power Considerations
- Management
  - Centralized Management
  - Management Systems
  - Bandwidth Management
  - VLANs, QoS, LLDP and other Standards

# Objectives

- Identify the various types of optical splitters and their principles of operation
- Identify the active electronic components in a Passive Optical LAN
- Understand the management principles for a POL

# Components - OLT

- OLT is head-end component
- Typically located in MDF or Data Center
- Manages connected ONTs
- Typically consist of:
  - Management
  - Switch Fabric
  - Uplink Interfaces
  - PON Interfaces
- Out-of-band Management

# Components – Large OLT Models

- Chassis-Based
- Fully Redundant
- Up to 224 PON Ports
- Thousands of ONTs
- DC Powered





# Components – Small OLT Models

## Small OLTs

- AC and DC Power
- Small Chassis and Standalone
- Small Office/Field Office
- 4 to 16 PON Ports
- Hundreds of ONTs



# Components – OLT Uplinks

- Standard Ethernet uplinks to core
- Uplinks typically 1G or 10G pluggable optics
- VLANs trunked into uplink ports
- Uplinks can be combined into LAGs

# Components – OLT PON Ports

- From 4 to 224 PON ports per OLT
- Each PON port typically supports 32 ONTs  
= Thousands of ONTs per OLT!
- Typically SFP based
- Class C+ optics feature 32dB loss budget

# Components – OLT Redundancy

## Typically Redundant

- Power
- Backplane
- Management
- Switch fabric
- Uplinks

## Sometimes Redundant

- PON Ports
- PON Cards
- Entire OLT

# Optical Splitters

- Splitters provide optical connections in pairs
- Each 1x2 split equates to  $\frac{1}{2}$  of the optical power
  - ~3dB loss
- Splitters range from 1x2 up to 1x64 splitters
- 1x32 is the most common split ratio for POL

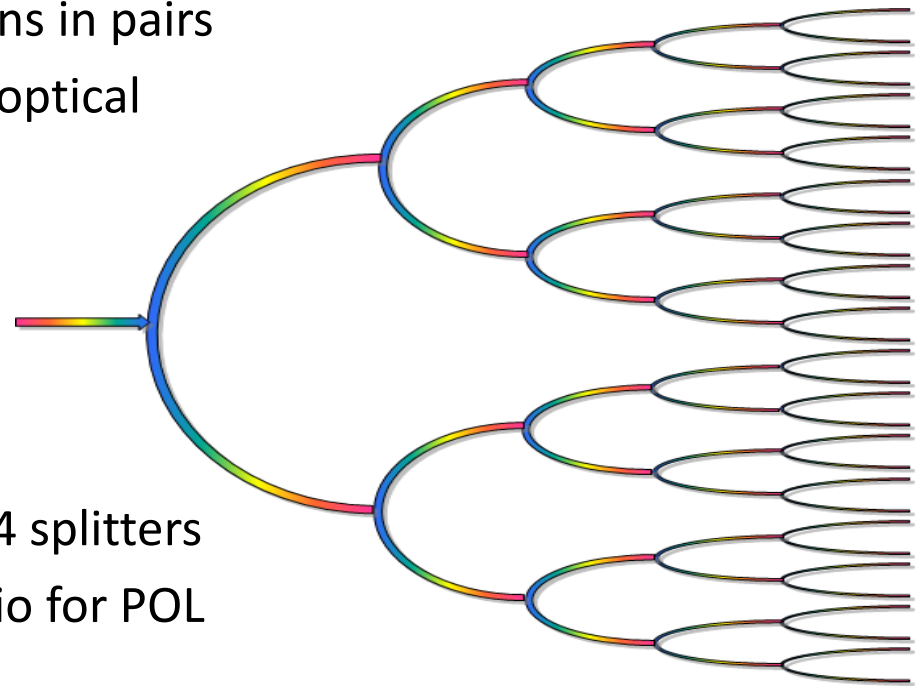

# Splitter Loss

Splitter	Max Loss*	Typical Loss*	Wavelength Range
1x2	3.8dB	3.1dB	1260-1360nm and 1480 -1580nm**
2x2	4.3dB	3.2dB	1260 - 1635nm
1x4	7.2dB	6.6dB	1260 - 1635nm
2x4	7.8dB	6.7dB	1260 - 1635nm
1x8	10.3dB	9.7dB	1260 - 1635nm
2x8	10.9dB	9.8dB	1260 - 1635nm
1x16	13.5dB	12.8dB	1260 - 1635nm
2x16	14.1dB	12.9dB	1260 - 1635nm
1x32	16.7dB	16.0dB	1260 - 1635nm
2x32	17.4dB	16.2dB	1260 - 1635nm
1x64	20.4dB	19.7dB	1260 - 1635nm
1x2 + 1x16	17.3dB	15.9dB	1260 - 1635nm
1x4 + 1x8	17.5dB	16.3dB	1260 - 1635nm

\* Includes PDL, WDL and TDL. Does not include connector loss



\*\* May not be compatible with NG PON1 or NG PON2

# Optical Splitter

The term "passive" in Passive Optical Network refers to the fact that the splitter requires no power as opposed to an "active" device like the OLT or switches in a traditional network. The splitter serves to optically replicate upstream signals to a number of downstream fibers. The typical number of fibers served in a PON network is 32. As the splitter provides a replicated optical signal to all 32 subscribers downstream, it is simultaneously combining those 32 fibers into a single feeder fiber in the upstream direction. Consequently the optical splitter is sometimes referred to as a splitter/combiner. The splitter will be housed in a number of form factors.



# PLC Splitter

## Planar Lightwave Circuit (PLC) Splitter

- More Expensive
- Uniform Output
- Most appropriate for outdoor use
- Manufacturing
  1. Waveguide used to split the optical signal is fabricated using a silicon dioxide chip.
  2. Involves a lithographic process similar to that used in the manufacture of silicon computer chips. PLC splitters provide the most uniformity between fiber outputs (the downstream fibers) with respect to the amount of optical loss measured on each fiber.
- Best choice when loss is critical



# Planar Light Circuit/Planar Waveguide

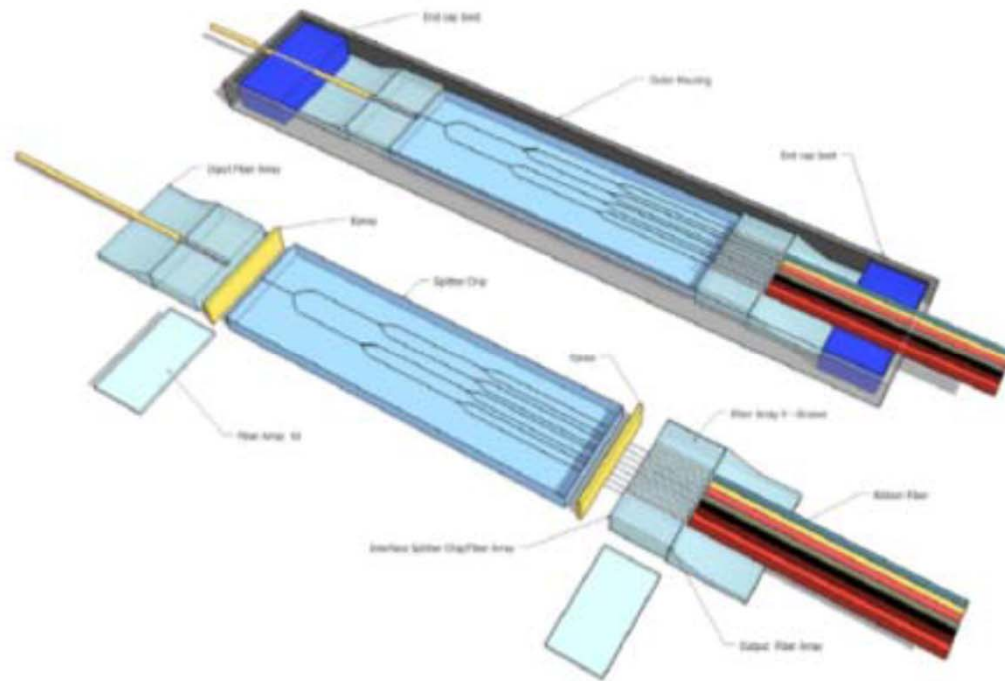

# FBT Splitter

## Fused Biconical Taper (FBT) splitter

- Lower Cost
- Typically less uniform from fiber to fiber.
- Manufacturing
  1. Thermally fused two overlapping fibers together under tension
  2. The resulting fusion splice creates a two by two splitter.
  3. Typically, one of these fiber connections is trimmed off and the result is a single fiber subtending to two fibers.
  4. These two fiber outputs can then be fused to additional one-by-two splitters until the desired number of splits is achieved.
- Used where extreme temperature variations or other environmental factors are not likely to cause the optics connected at the ends of the fiber to drift from their optimum wavelength specifications.

# 2xN Splitters

- 2 Inputs
- 2 to 64 Outputs
- Second Input Allows
  - Redundant feeders/PON Ports/PON Cards/OLTs
  - Easier Migration to 10G
  - Flexibility for the Future

# ONTs

- ONT located close to the end user
- Fiber input
- Variety of user interfaces available
- Provide PoE
- Consume ~7W power + PoE draw

# ONT Models - Traditional

- Large variety of ONTs available
- AC and DC power options
- Desk-mount, In-wall, and Rack-mount
- Battery backup
- Match interfaces to user needs:
  - Ethernet Ports with PoE
  - POTS Ports
  - Coaxial Television
  - Wi-Fi



# ONT Models - Unique

In-Wall

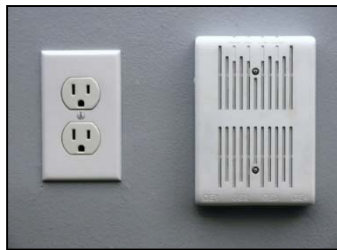

Rack-Mount



Industrial/Outdoor



# ONT Connections

## What Can I Connect?

- PCs
- Thin Clients
- VoIP Phones
- POTS Phones
- Wireless Access Points
- Coaxial Cable TV
- IPTV
- Access Control
- Security Cameras
- Building Management Systems
- Biometric Sensors
- Anything with an Ethernet, POTS, or Coax Interface!

# ONT Compatibility

- EPON and GPON are not compatible
- Different manufactures *typically* choose not interoperate
- Beyond the standards, some manufacturers implement additional features – especially true in EPON



# ONT Security

- ONT security designed to assume the ONT is in the hands of the adversary
- ONT does not function without OLT
- Usually no management ports on ONT
- ONT receives all programming from OLT

# Power Considerations

- ONTs report a loss of power or loss of service
- ONTs can be powered via AC or DC
- Battery backups for high availability
- PoE and PoE+ available

# Components - Video

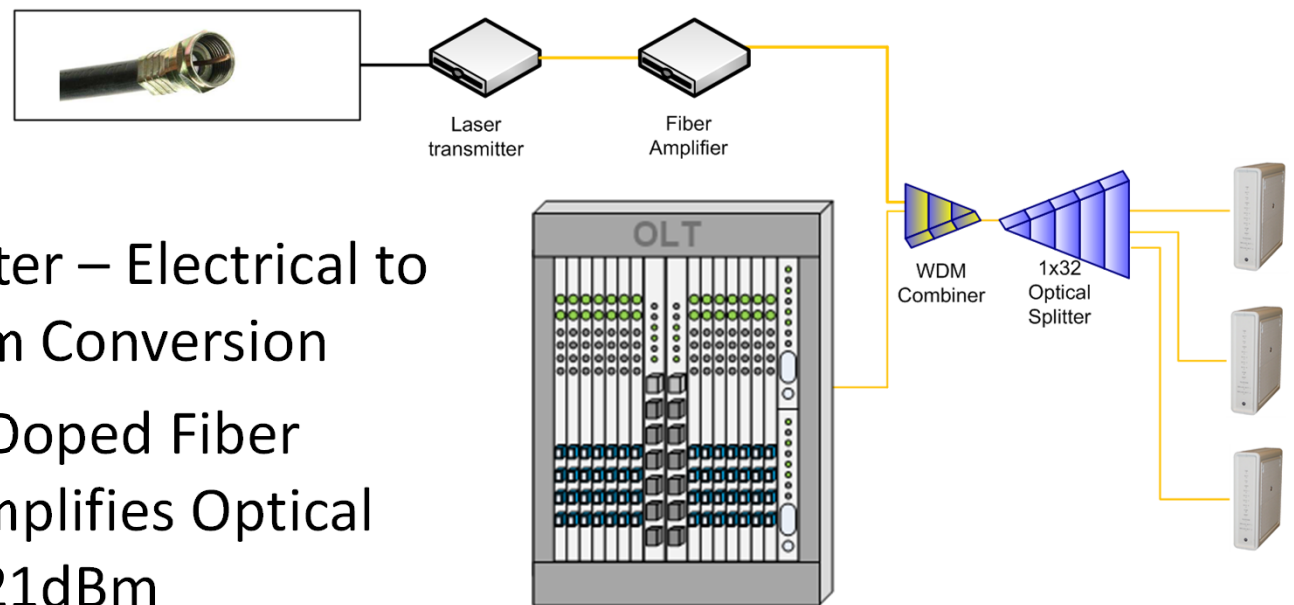

- Laser Transmitter – Electrical to Optical 1550nm Conversion
- EDFA (Erbium Doped Fiber Amplifier) – Amplifies Optical Signal to 18 – 21dBm
- WDM – Combines Wavelengths

# Components - Video

- Laser Transmitter
- EDFA
- RF Nodes
- RFoG/two-way



# Components – DC Power

- Most OLTs use -48V DC Power
- Same power used in telco central offices
- Rectifiers required to convert AC to DC
- Properly ground your equipment!



Photo - Cassell & Co., Ltd.

# Components – DC Power



- Redundant Inputs
- Redundant Outputs
- Redundant Rectifiers
- Fuse or Circuit Breaker Protection
- Network Management
- Basically an external power supply!

# Centralized Management

- ONTs Centrally Managed
- No physical ONT management ports
- Same concepts as traditional network
  - VLANs
  - PoE
  - QoS

# Centralized Management

**ZHONE**  
Bandwidth Changes Everything™  
Home Services Faults Administration

Dashboard

- CONFIGURATION
- ALARMS
- BANDWIDTH UTILIZATION
- DEVICES

Dashboard Settings

Device: Performance Show All Show None

**CONFIGURATION**

- Network Elements
- Reports
- Server

**ALARMS**

DeviceName	Type	Name	Description
Host 01.38.172.16	Device_AlarmEvent	DEVICE_REACH	The device is not reachable
Shore Mac172.16.18.198	Device_AlarmEvent	POWER_SUPPLY_1B	Power supply 1 failure
172.16.18.198	Device_AlarmEvent	POWER_SUPPLY_1B	Power supply 1 failure
Host 01.38.172.16	Device_AlarmEvent	POWER_SUPPLY_1B	Power supply 1 failure
Host 01.38.172.16	Device_AlarmEvent	PULL_UPSTATE_2A	A full config sync update has failed
Shore Mac172.16.18.198	Card_AlarmEvent	CARD_FAULT_2B	Card fault error
172.16.18.198	Physical_AlarmEvent	L2M_COVIM_ALARM	Ethernet communication link is down (1:18-1:0)
172.16.18.198	Physical_AlarmEvent	L2M_COVIM_ALARM	Ethernet communication link is down (1:18-2:0)
172.16.18.198	Physical_AlarmEvent	L2M_COVIM_ALARM	Ethernet communication link is down (1:18-3:0)
172.16.18.198	Physical_AlarmEvent	L2M_COVIM_ALARM	Ethernet communication link is down (1:18-4:0)
172.16.18.198	Physical_AlarmEvent	L2M_COVIM_ALARM	Ethernet communication link is down (1:18-5:0)
172.16.18.198	Physical_AlarmEvent	L2M_COVIM_ALARM	Ethernet communication link is down (1:18-6:0)
172.16.18.198	Physical_AlarmEvent	L2M_COVIM_ALARM	Ethernet communication link is down (1:18-7:0)
172.16.18.198	Physical_AlarmEvent	L2M_COVIM_ALARM	Ethernet communication link is down (1:18-8:0)

**BANDWIDTH UTILIZATIONS**

Bar chart showing bandwidth utilization across various devices.

**USERS**

Pie chart showing user distribution.

Tellabs Panorama PON

File Edit View Profiles Tools Windows Help

Network

- BigD
- MDS
- 01 4xGPON
- 02 4xGPON
- 03 4xGPON
- 04 4xGPON
- 05 4xGPON
- 06 4xGPON
- 07 4xGPON
- 08 4xGPON
- 01 PON
- 02
- 03
- 04
- 05
- 09 4xGPON
- 10 4xGPON
- 11 4xGPON
- 12 4xGPON
- 13 4xGPON
- 14 4xGPON
- 15 4xGPON
- 16 4xGPON
- A TDU
- B TDU
- 19 ESU2
- 20 ESU2
- 26 AMU
- CLL-MDS17
- CORP-1150
- DMW-NE146

Equipment

BigD @ 08 OOM17 @ 01 PON

Equipment details showing ports and connections.

User emsadmin logged on. aname

Wed Aug 21, 11:07 AM Tellabs Panorama PON





# Management Systems

- Systems included standard CLI and EMS
- OLT runs without management server
- Application and Web/Mobile
- GUI is more important in PON than legacy networks
  - Density is far greater!
- ONTs are an extension of the OLT

# Profiles & Templates

- Create a standard profile or template for your services
- Apply that profile or template to many ONTs at once!

# Management Systems Features

- Alarming and Notification
- Bandwidth Monitoring
- Central OLT & ONT Upgrades
- MAC Searches
- VLAN Member Reports

# Bandwidth Management

- Bandwidth Management is Built-in!
- Guarantee every user bandwidth
  - Set a committed rate
  - Committed rates cannot exceed capacity of any link in the system
- Manage additional bandwidth as you desire
  - Set a peak rate

# Managing All The Same Things

The same things you manage today...

- VLANs
- PoE
- QoS
- LLDP
- Network Access Control

# What makes PON a POL?

1. Indoor ONTs
2. Power over Ethernet
3. Internal Packet Switching
4. Enterprise Ethernet Features

# Questions?

## Introduction to POL Components

Matt Miller

AECOM



# Introduction to POL Design



Chad Hines  
IT Connect





# Section 9 Agenda

- POL Component and Budget Review
- POL Cable Design Options Overview
- Design Challenge Exercise
- Knowledge Check

# APC and UPC

- Ultra Physical Contact Connectors (UPC)
  - Blue



- Angled Physical Connectors (APC)
  - Green



# Splitter Deployment

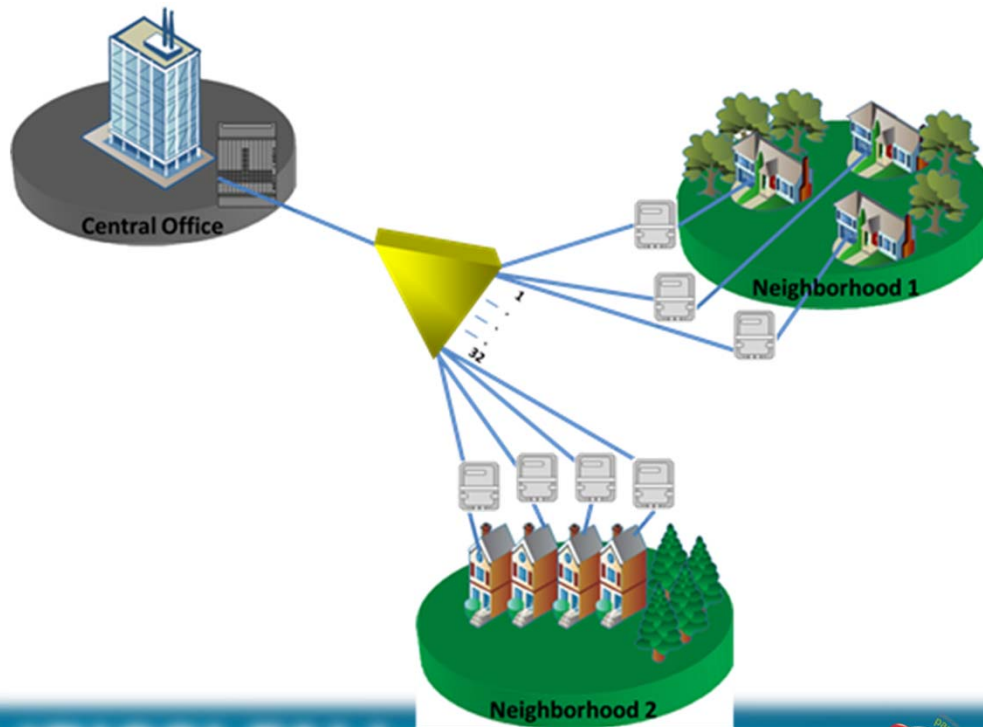

## Single Splitter

- One splitter in the Optical Distribution Network
- All splitter loss is at one location
- Works for 99% of POL deployments

# Splitter Deployment

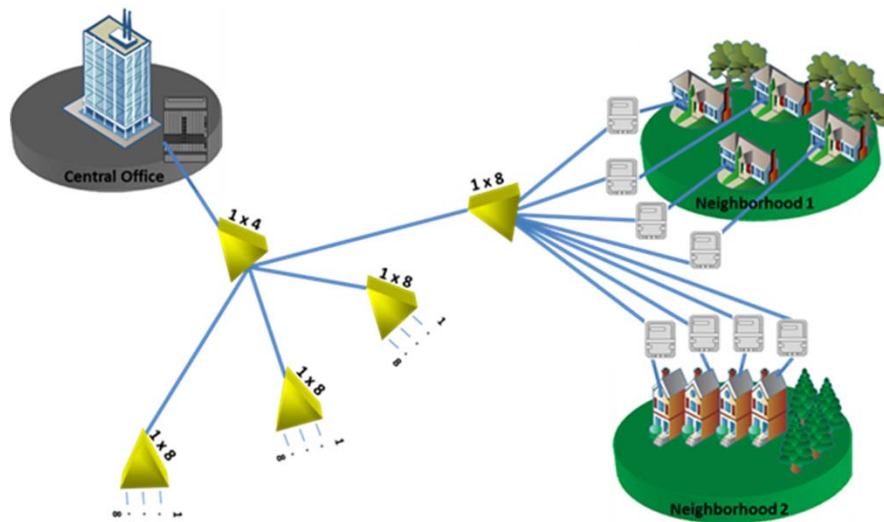

## Cascaded Splits

- Used when end users are geographically dispersed
- Campus out-buildings
- Loss from splitters in path must be summed

## Engineered Splits

- Loss may favor a particular output

# Centralized Split Overview

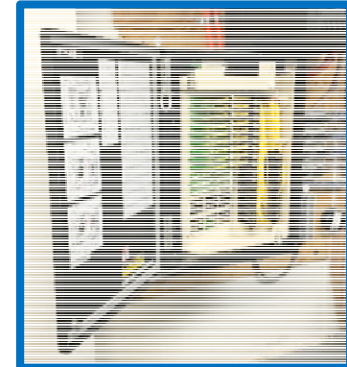
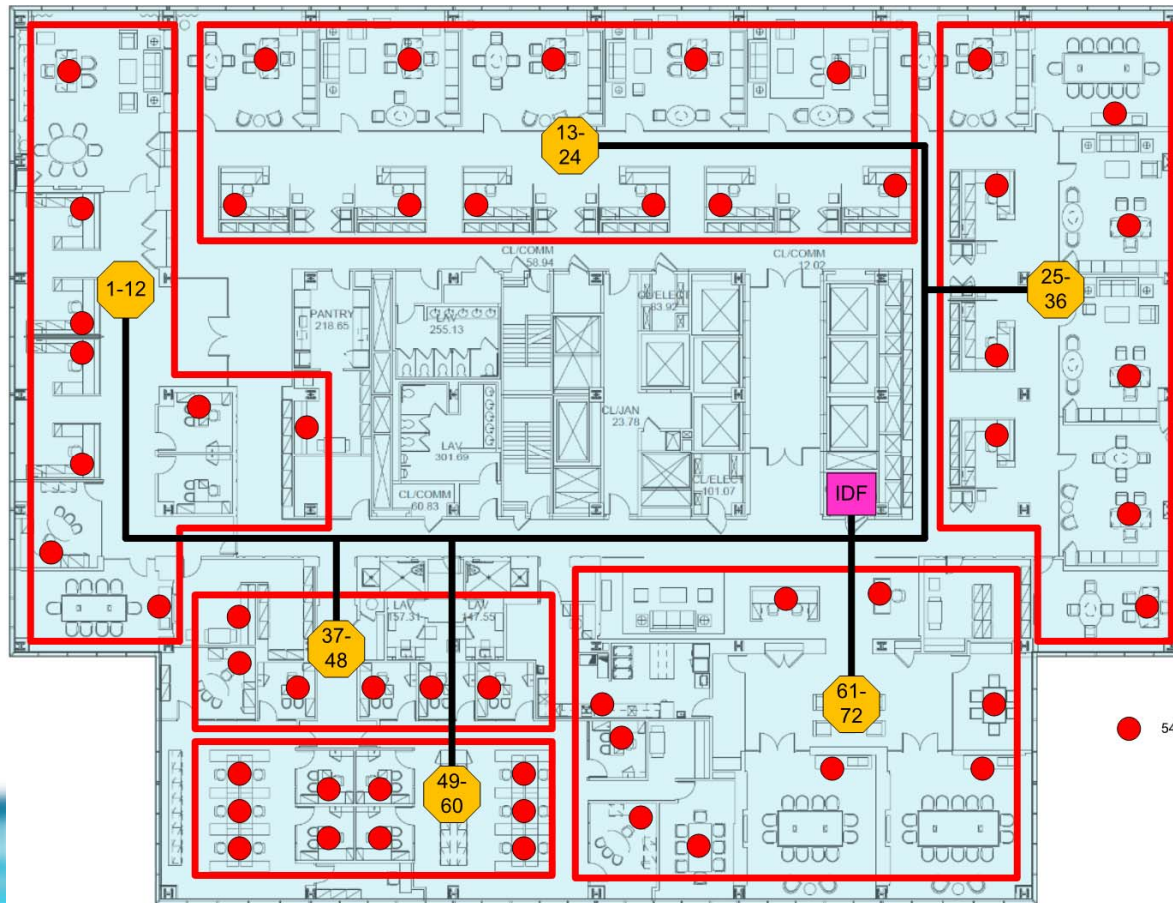

**FDH  
Houses Splitters**



**Consolidation Point  
Zone Cabling**

# Centralized Splitting

- Provides maximum ROI for POL
- Houses splitters in one location per floor
- Installation Labor hours are reduced
- Connection between Riser and Horizontal

# Centralized BoM

Area	Product Description	Total Qty
MDF	Rack Mount Fiber Enclosure, 1U, holds 3 MPO Fiber cassettes	
MDF	MPO Fiber Cassette	
IDF	1 x 32 splitter used with FDH	
IDF	288-Port capacity FDH accommodating 18 splitters and 24 MPO outputs	
Horizontal	24 port Consolidation Point w/300 foot Plenum MPO Cable	
ONT Fiber	SCAPC-SCAPC Plenum Yellow 3 (10')	
OLT Fiber	SCUPC-SCAPC Plenum Yellow 8 (25')	
Horizontal	SCAPC-SCAPC Plenum Yellow 23 (75')	
Horizontal	SCAPC-SCAPC Plenum Yellow 31 (100')	
Horizontal	SCAPC-SCAPC Plenum Yellow 38 (125')	
Horizontal	SCAPC-SCAPC Plenum Yellow 46 (150')	
WAO	4-port White Faceplate	
WAO	SCAPC Singlemode adapter	
WAO	Category 6 modular jack	
WAO	RJ45 plug to RJ45 plug, T568B Blue	

# Zone Split Overview

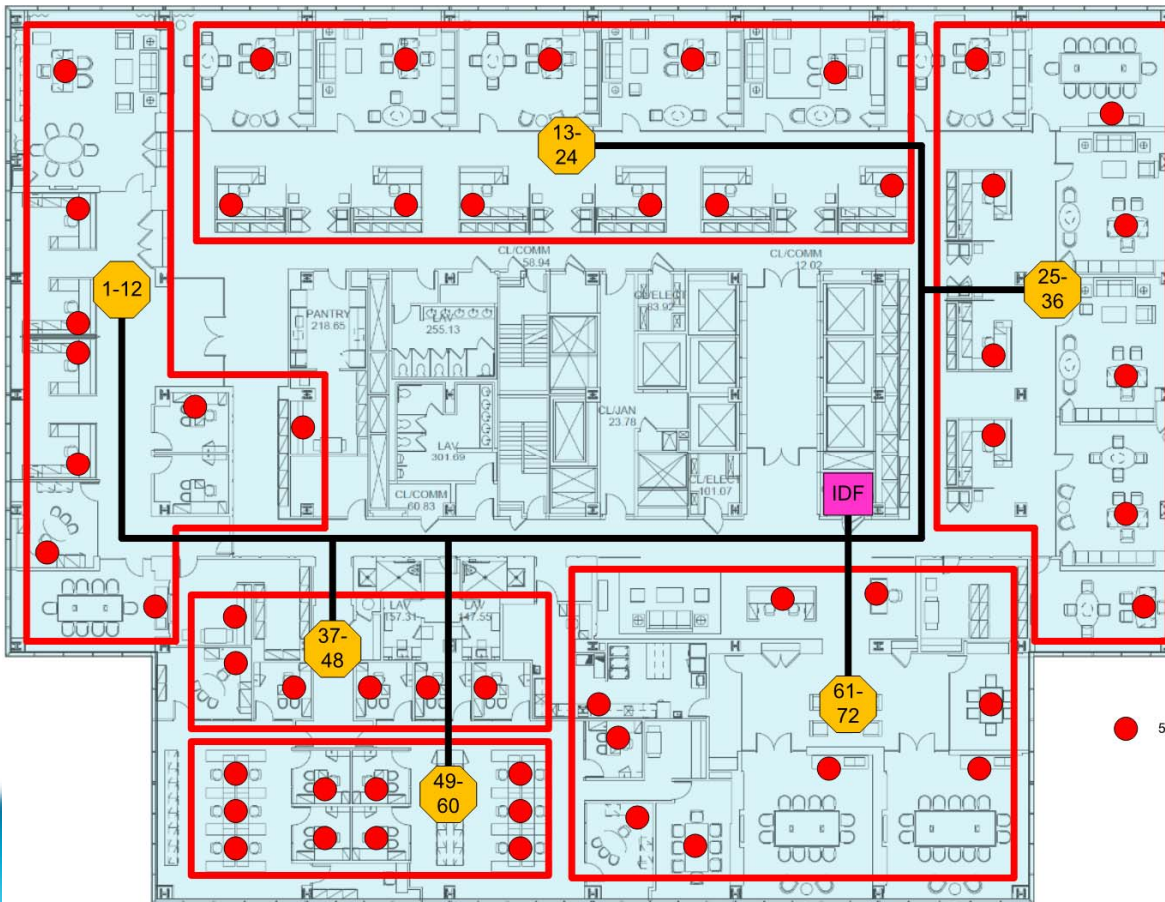

Zone Splitter Housing



# Zone Splitting

- Eliminates the need for the IDF
- Places Splitter closer to user
- Location for cross-connects
- Termination for horizontal and feeder fiber
- Moves redundancy closer to the user in Type B applications.

# Zone BoM

Area	Product Description	Total Qty
MDF	Rack Mount Fiber Enclosure, 2U, holds 6 MPO Fiber cassettes	
MDF	MPO Fiber Cassette	
IDF	MPO Fiber Trunk 12 Strand Singlemode Plenum (100 foot)	
IDF	MPO Fiber Trunk 12 Strand Singlemode Plenum (200 foot)	
IDF	MPO Fiber Trunk 12 Strand Singlemode Plenum (300 foot)	
Horizontal	1 x 32	
Horizontal	Fiber Zone Box	
Horizontal	Fiber Zone Box Installation Kit	
ONT Fiber	SCAPC-SCAPC Plenum Yellow 3 (10')	
OLT Fiber	SCUPC-SCAPC Plenum Yellow 8 (25')	
Horizontal	SCAPC-SCAPC Plenum Yellow 23 (75')	
Horizontal	SCAPC-SCAPC Plenum Yellow 31 (100')	
Horizontal	SCAPC-SCAPC Plenum Yellow 38 (125')	
Horizontal	SCAPC-SCAPC Plenum Yellow 46 (150')	
WAO	Faceplates 4-port White Alpine	
WAO	SCAPC Singlemode adapter	
WAO	Category 6 modular jack	
WAO	RJ45 plug to RJ45 plug, T568B Blue	

# Rack Mount Split Overview

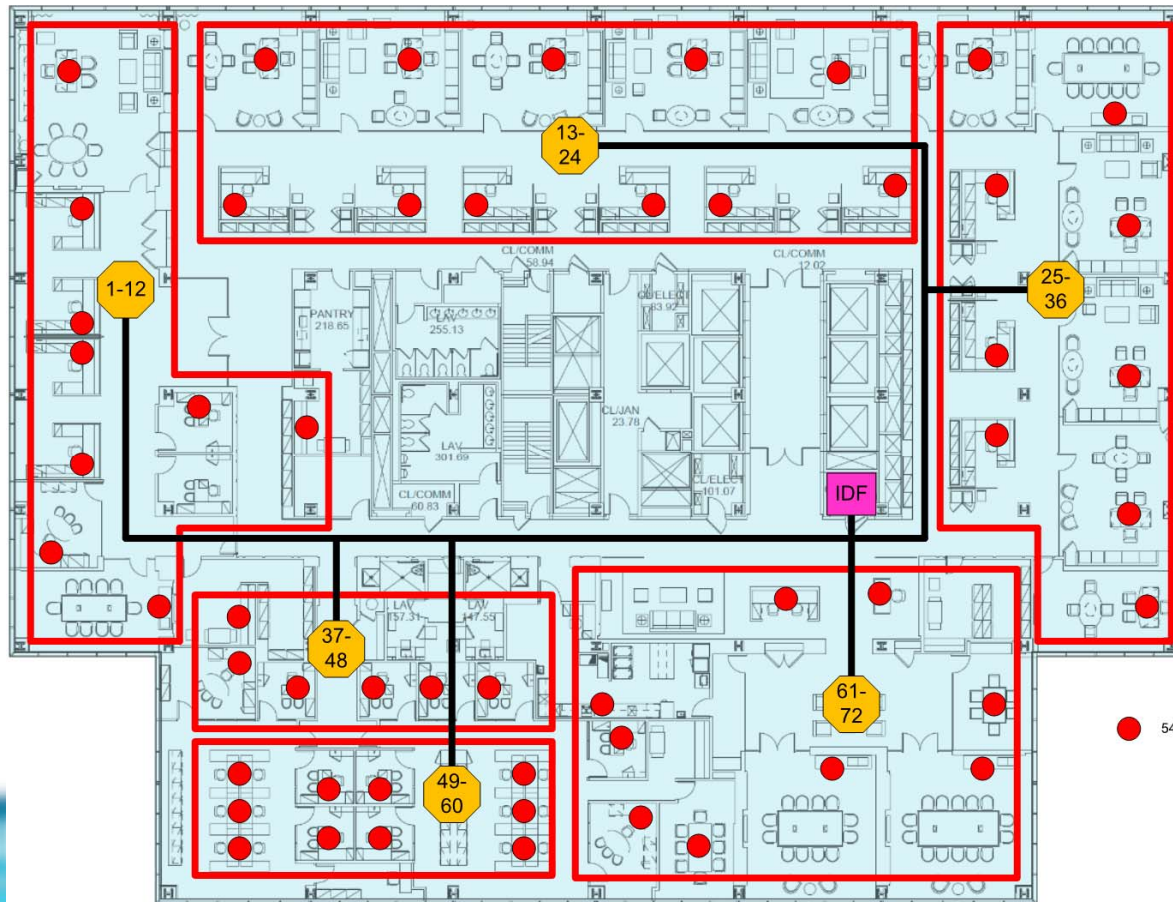

# Rack Mount Splitting

- Customer used to look and feel
- Splitters are rack-mounted or installed in fiber housing modules
- Fiber is terminated on patch panels
- Can use Pre-terminated or field connectorized cable

# Rack BoM

Area	Product Description	Total Qty
MDF	Rack Mount Fiber Enclosure, 2U, holds 6 MPO Fiber cassettes	
MDF/IDF	MPO Fiber Cassette	
IDF	Wall Mount 2-Post Open Frame Rack Cabinet 8U	
IDF	Rack Mount Fiber Enclosure, 1U, holds 2 MPO Fiber cassettes	
IDF	Rack Mount Fiber Enclosure, 2U, holds 6 Panels	
IDF	SC Adapters, Simplex, APC, 12 F, Single-mode	
Riser	MPO Fiber Trunk 12 Strand Singlemode Plenum (100 foot)	
Riser	MPO Fiber Trunk 12 Strand Singlemode Plenum (200 foot)	
Riser	MPO Fiber Trunk 12 Strand Singlemode Plenum (300 foot)	
IDF	Rack Mounted 1 x 32 splitter	
ONT Fiber	SCAPC-SCAPC Plenum Yellow 3 (10')	
OLT Fiber	SCUPC-SCAPC Plenum Yellow 8 (25')	
Horizontal	SCAPC-SCAPC Plenum Yellow 23 (75')	
Horizontal	SCAPC-SCAPC Plenum Yellow 31 (100')	
Horizontal	SCAPC-SCAPC Plenum Yellow 38 (125')	
Horizontal	SCAPC-SCAPC Plenum Yellow 46 (150')	
WAO	Faceplates 4-port White Alpine	
WAO	SCAPC Singlemode adapter	
WAO	Category 6 modular jack	
WAO	RJ45 plug to RJ45 plug, T568B Blue	

# Hybrid Deployments

- Some deployments choosing hybrid deployments
- Hybrid Ideas
  - Keep IDFs for rack-mount ONTs, but use fiber zone hubs
  - Put ONTs in active zone box and run category cabling to user
  - Use 100% rack-mount ONTs in retrofit scenario

# Campus Overview

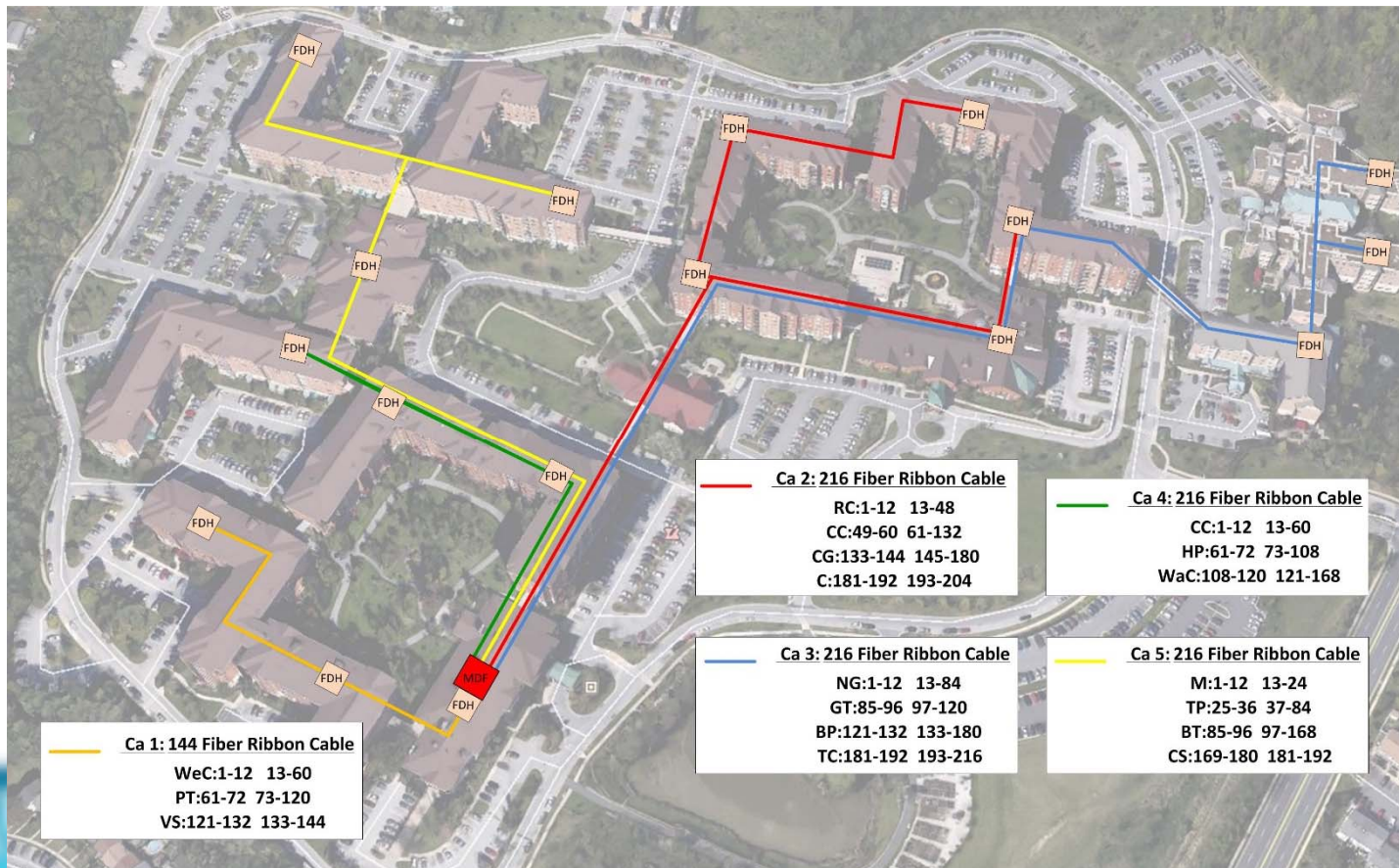

# OSP Deployment

- OSP options can be mixed with LAN options
- Be careful of mixing manufacturer product lines due to incompatibility issues
- Many options due to PON history in telecommunications



# Good Design Practices

- ✓ Meets customer requirements
- ✓ Provides a value to the customer:
  - ✓ Reduced Cost
  - ✓ Power/Space/Cooling
  - ✓ Performance
  - ✓ Longevity
- ✓ Is not overly complex
- ✓ Makes customer happy!

# End of Day One

Founding Members:



[www.apolanglobal.org](http://www.apolanglobal.org)

# Day 1 Review

Matt Miller  
AECOM



# Passive Optical LAN is a standards based/recognized technology

- ✓ A. True
- B. False

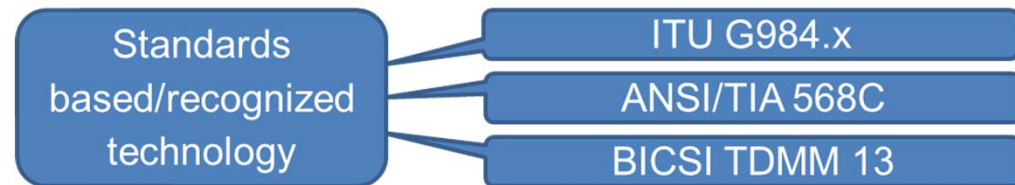

# Guaranteed bandwidth is possible with...

- ✓ A. Passive Optical LAN
- B. Switch Based
- C. Both A and B

<u>Similar</u>	<u>Different</u>
Standards Based	Point to Multipoint
Local Area Network	Multiple Services
Enterprise Management	Guaranteed Bandwidth
Ethernet Frame Transport	Single Strand of SM Fiber
802.1x – 802.1Q – PoE	No Access and Distribution

# POL supports 802.1Q VLANs

- ✓ A. True
- B. False

## Similar

Standards Based

Local Area Network

Enterprise Management

Ethernet Frame Transport

802.1x – 802.1Q – PoE

## Different

Point to Multipoint

Multiple Services

Guaranteed Bandwidth

Single Strand of SM Fiber

No Access and Distribution

# AES 128 Encryption is present in \_\_\_\_\_ direction(s)

- A. The upstream
- ✓ B. The downstream
- C. Both upstream and downstream

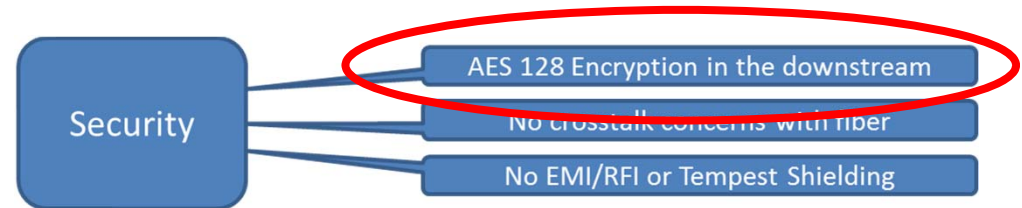

# Gigabit switches provide 1Gb/s connections to every WAO

- A. True
- ✓ B. False

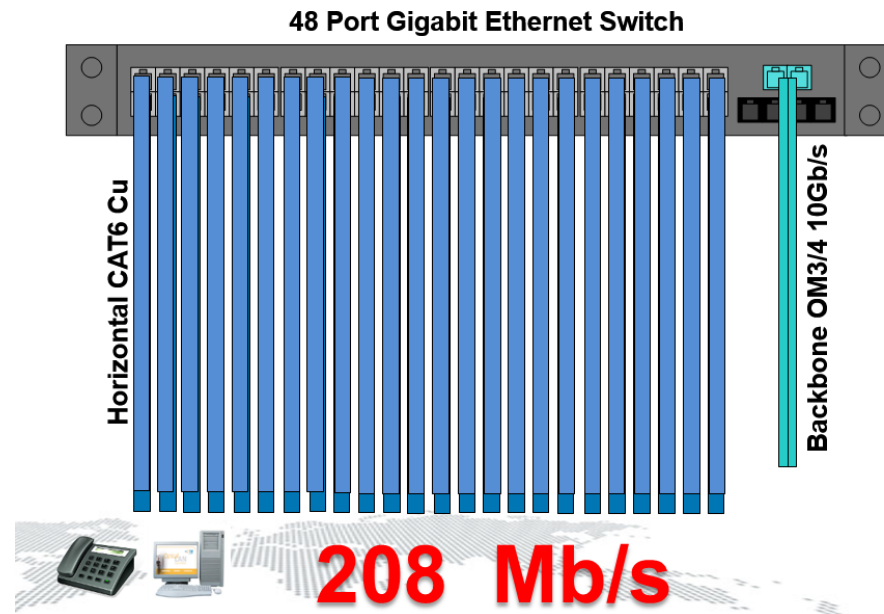









# Most users consume bandwidth all day long

- A. True
- ✓ B. False

Most users use 0Mb/s over 98% of the workday

#### Apps (7)

- ▶  Microsoft Lync (32 bit)
- ▶  Microsoft Outlook (32 bit) (2)
- ▶  Microsoft PowerPoint (32 bit)
- ▶  Photos
- ▶  Snipping Tool
- ▶  Task Manager
- ▶  Windows Explorer

App	Usage %	Usage (MB)	Bandwidth (MB/s)	Bandwidth (Mbps)
Microsoft Lync (32 bit)	0%	55.8 MB	0 MB/s	0.1 Mbps
Microsoft Outlook (32 bit) (2)	0%	92.6 MB	0 MB/s	0 Mbps
Microsoft PowerPoint (32 bit)	2.3%	192.5 MB	0 MB/s	0 Mbps
Photos	0%	0.1 MB	0 MB/s	0 Mbps
Snipping Tool	0%	2.2 MB	0 MB/s	0 Mbps
Task Manager	1.6%	10.8 MB	0 MB/s	0 Mbps
Windows Explorer	1.4%	147.3 MB	0 MB/s	0 Mbps

# This technology uses Dynamic Bandwidth Allocation

A. Switch Based

✓ B. Passive Optical LAN

Switch Data vs. Dynamic Bandwidth Allocation

# Most users require a sustained GbE connection

- A. True
- ✓ B. False

Common LAN Services	Typical Required Bandwidth
Email and Web Browsing	500Kbps
Voice over IP	110Kbps
Cloud-based Services (data storage, enterprise s/w, collaboration, etc...) Low	50Kbps
Cloud-based Services (data storage, enterprise s/w, collaboration, etc...) High	100Kbps
Wireless Access Point Capacity (IEEE 802.11 a/b/g/n)	24Mbps
Wireless Access Point High Capacity (IEEE 802.11 ac/ad, dual radio)	300Mbps
IP Video Surveillance Standard Definition (MPEG4/H.264)	2Mbps
IP Video Surveillance High Definition (MPEG4/H.264)	6Mbps
IP Video Conferencing / Telepresence (720p-Good, includes primary/auxiliary)	2Mbps
IP Video Conferencing / Telepresence (1080p-Best, includes primary/auxiliary)	15Mbps

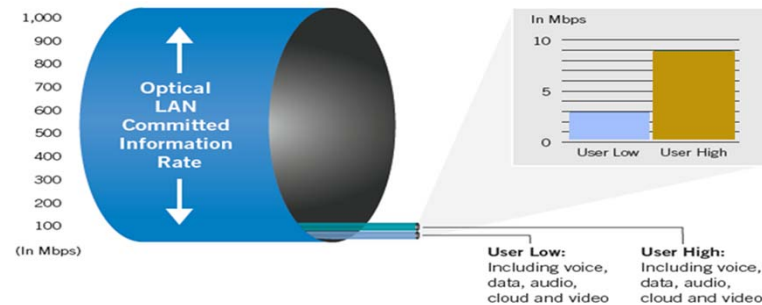

## Upstream (ONT to OLT) analog video utilizes which wavelength?

- A. 1550nm
- B. 1490nm
- C. 1310nm
- D. 1625nm
- ✓ E. None



1550nm Downstream ONLY –  
RF Video

# A cascaded 1x4 + 1x16 split is a good practice?

- A. True
- ✓ B. False

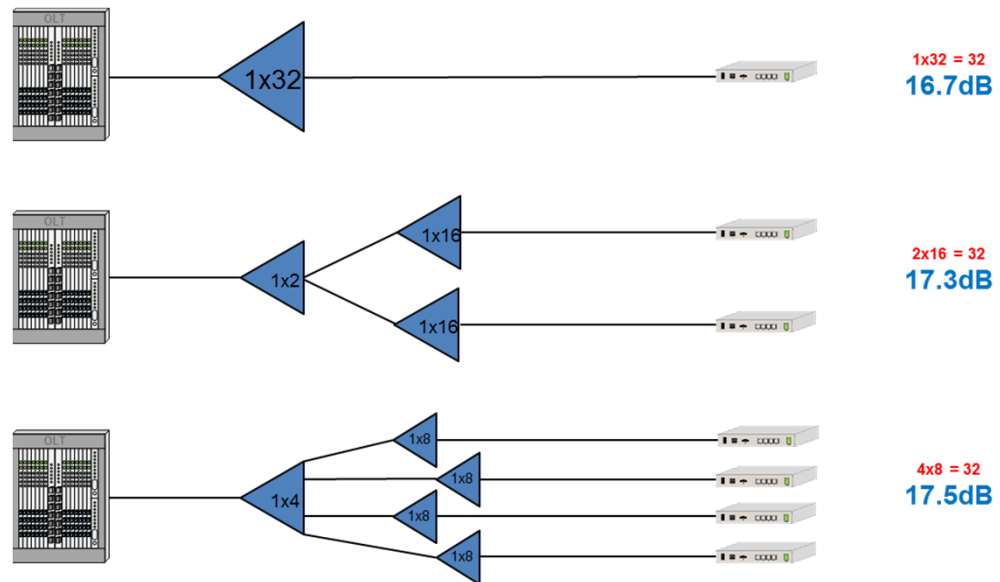

# GPON bandwidth can be increased by using a lower split ratio

- A. True
- ✓ B. False

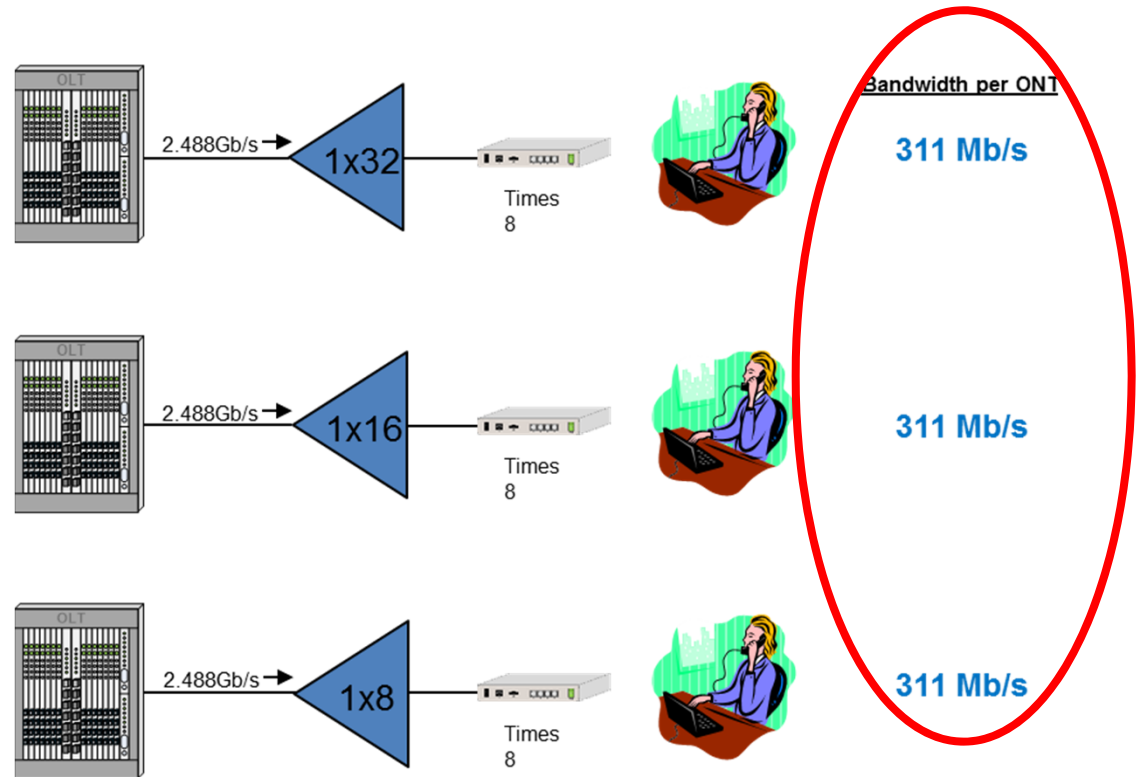

# The minimum loss required between the OLT and ONT is...

- A. 13.5dB
- B. 10.7dB
- ✓ C. 15.5dB
- D. 17.2dB
- E. None of these

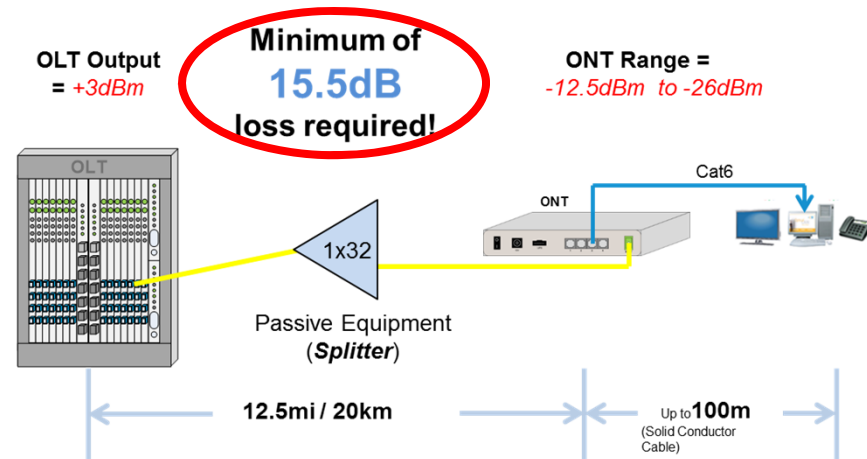

# PoE in a POL is administered at the...

- A. OLT
- ✓ B. ONT
- C. Injector
- D. PoE is not possible

## ONT – Optical Network Terminal

- Active equipment provided by suppliers such as Tellabs and Zhone.
- Located near the user or device
- Typically 4 RJ45 (10/100/1000) outputs with optional POE
- Up to 60W of available POE (vendor specific)
- Standard HVAC is adequate
- Optional internal or external battery back-up
- POTS and COAX ports available
- Establishes and maintains secure AES 128 Encryption
- Supports multiple VLANs on each port



ONT



## Which of these are a benefit of POL?

- A. Reduction in power
- B. Reduction of fire load
- C. Reduction of non-renewable materials
- ✓ D. All of these are benefits

### Green Benefits

- Reduction in power consumption
- Reduction in non-renewable materials
- Ceiling space and fire load savings
- Reduction in cabling costs
- Floor space savings

## LEED Credits are

- ✓ A. Possible with POL
- B. Automatic with POL
- C. Guaranteed with POL
- D. Not Possible with POL

- Energy and Atmosphere Credit 1 (1-3 pts).
  - Reduction in TRs, HVAC equipment, switch equipment, UPS, lighting and other energy needs.
  - The PON system helps the overall efficiency of the energy systems.
- Innovation in Design Credit 1 (1-4 pts).
  - The PON system utilizes less equipment, resulting in less raw materials, less garbage, less transportation and reduced time for implementation and commissioning.
  - In addition, utilizing a fiber system ensures the life of the system extends beyond the life of a conventional “switched” system.



\*not guaranteed or implied

## My retained knowledge of Passive Optical LAN from yesterday was...

- A. A little
- B. A lot
- C. What is Passive Optical LAN?
- D. None

# Questions?

Day 1 Review

Matt Miller

AECOM

BICSI FALL  
CONFERENCE & EXHIBITION



BicSI

# Design Scenario Challenge

Challenge – Determine the quantity of each component required for Passive Optical LAN design

Assumptions:

1. Using pre-terminated fiber throughout
2. ONTs will be shared at Cubicles
3. ONTs will be mounted under the desks
4. ONTs will be locally AC powered
5. OLT is located in MDF
6. Raised floor throughout building

OLT	1
ONT's	107
WAP's	26
Printers	9

## Assumptions

1. Using pre-terminated fiber throughout
2. ONTs will be shared at Cubicles
3. ONTs will be mounted under the desks
4. ONTs will be locally AC powered
5. OLT is located in MDF
6. Raised floor throughout building

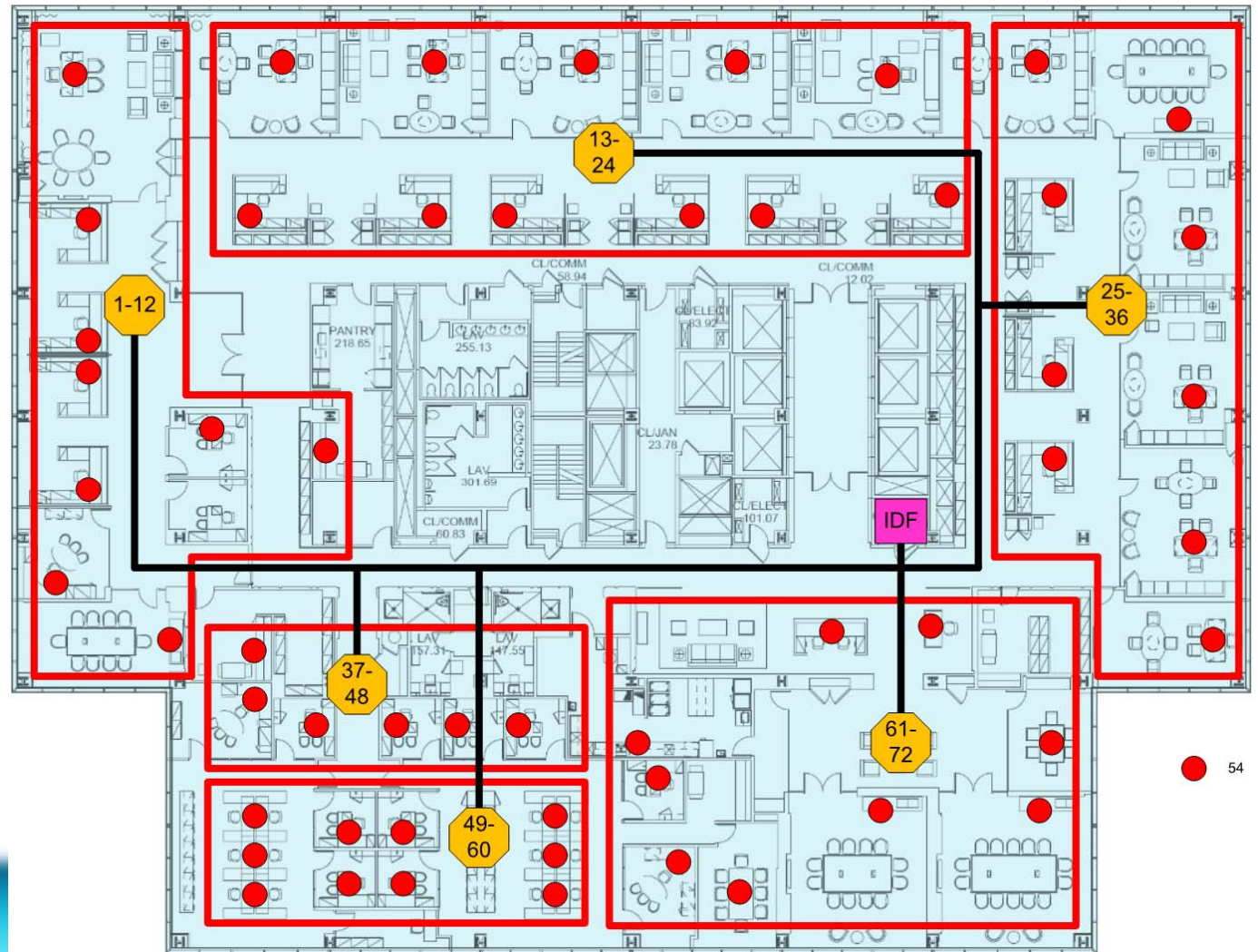

# Centralized Split Overview

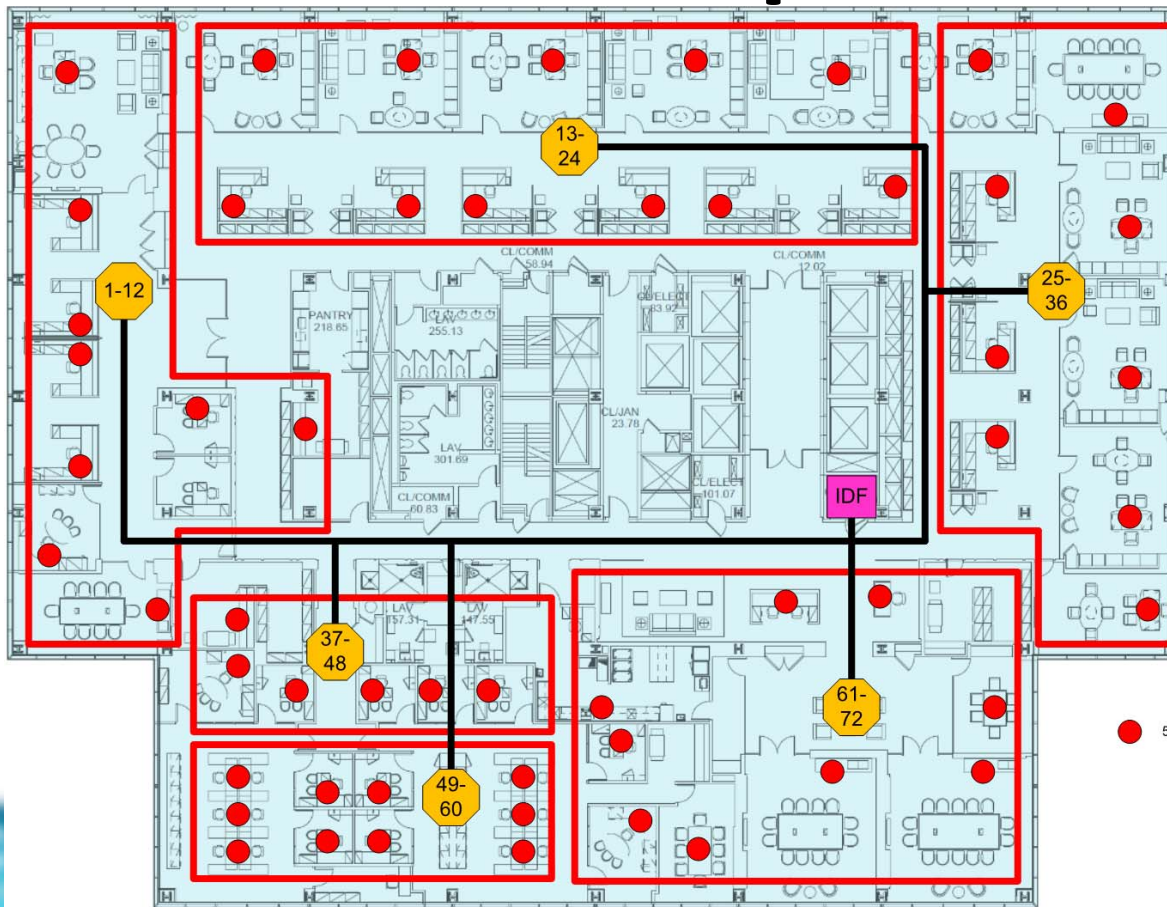

**FDH  
Houses Splitters**

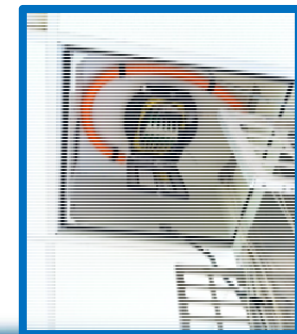

**Consolidation Point  
Zone Cabling**

# Centralized Scenario Answers

Area	Product Description	Total Qty
MDF	Rack Mount Fiber Enclosure, 1U, holds 3 MPO Fiber cassettes	1
MDF	MPO Fiber Cassette	2
IDF	1 x 32 splitter used with FDH	4
IDF	288-Port with 18 splitter ports 500' 24 MPO adapters	1
Horizontal	24 port Fiber Terminals w/300 foot Plenum Cable w/MPO	10
ONT Fiber	SCAPC-SCAPC Plenum Yellow 3 (10')	107
OLT Fiber	SCUPC-SCAPC Plenum Yellow 8 (25')	4
Horizontal	SCAPC-SCAPC Plenum Yellow 23 (75')	30
Horizontal	SCAPC-SCAPC Plenum Yellow 31 (100')	40
Horizontal	SCAPC-SCAPC Plenum Yellow 38 (125')	30
Horizontal	SCAPC-SCAPC Plenum Yellow 46 (150')	10
WAO	4-port White Faceplate	107
WAO	SCAPC Singlemode adapter	107
WAO	Category 6 modular jack	37
WAO	RJ45 plug to RJ45 plug, T568B Blue	251



# Zone Split Overview

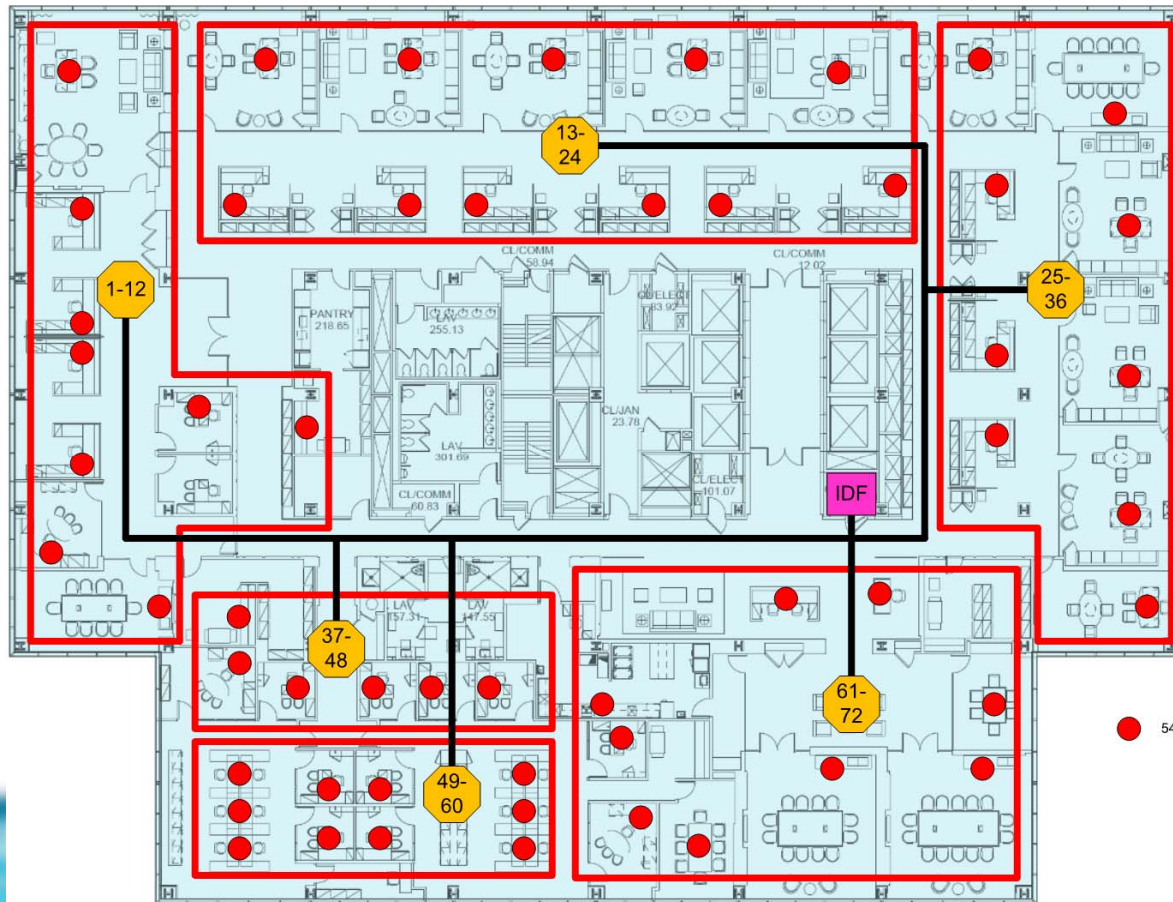

Zone Splitter Housing



# Zone Scenario Answers

Area	Product Description	Total Qty
MDF	Rack Mount Fiber Enclosure, 2U, holds 6 MPO Fiber cassettes	1
MDF	MPO Fiber Cassette	5
IDF	MPO Fiber Trunk 12 Strand Singlemode Plenum (100 foot)	1
IDF	MPO Fiber Trunk 12 Strand Singlemode Plenum (200 foot)	2
Horizontal	MPO Fiber Trunk 12 Strand Singlemode Plenum (300 foot)	2
Horizontal	1 x 32 Splitter	5
Horizontal	Fiber Zone Box	5
Horizontal	Fiber Zone Box Installation Kit	5
ONT Fiber	SCAPC-SCAPC Plenum Yellow 3 (10')	107
OLT Fiber	SCUPC-SCAPC Plenum Yellow 8 (25')	5
Horizontal	SCAPC-SCAPC Plenum Yellow 23 (75')	10
Horizontal	SCAPC-SCAPC Plenum Yellow 31 (100')	40
Horizontal	SCAPC-SCAPC Plenum Yellow 38 (125')	30
Horizontal	SCAPC-SCAPC Plenum Yellow 46 (150')	30
WAO	Faceplates 4-port White Alpine	107
WAO	SCAPC Singlemode adapter	107
WAO	Category 6 modular jack	37
WAO	RJ45 plug to RJ45 plug, T568B Blue	251

# Rack Mount Split Overview

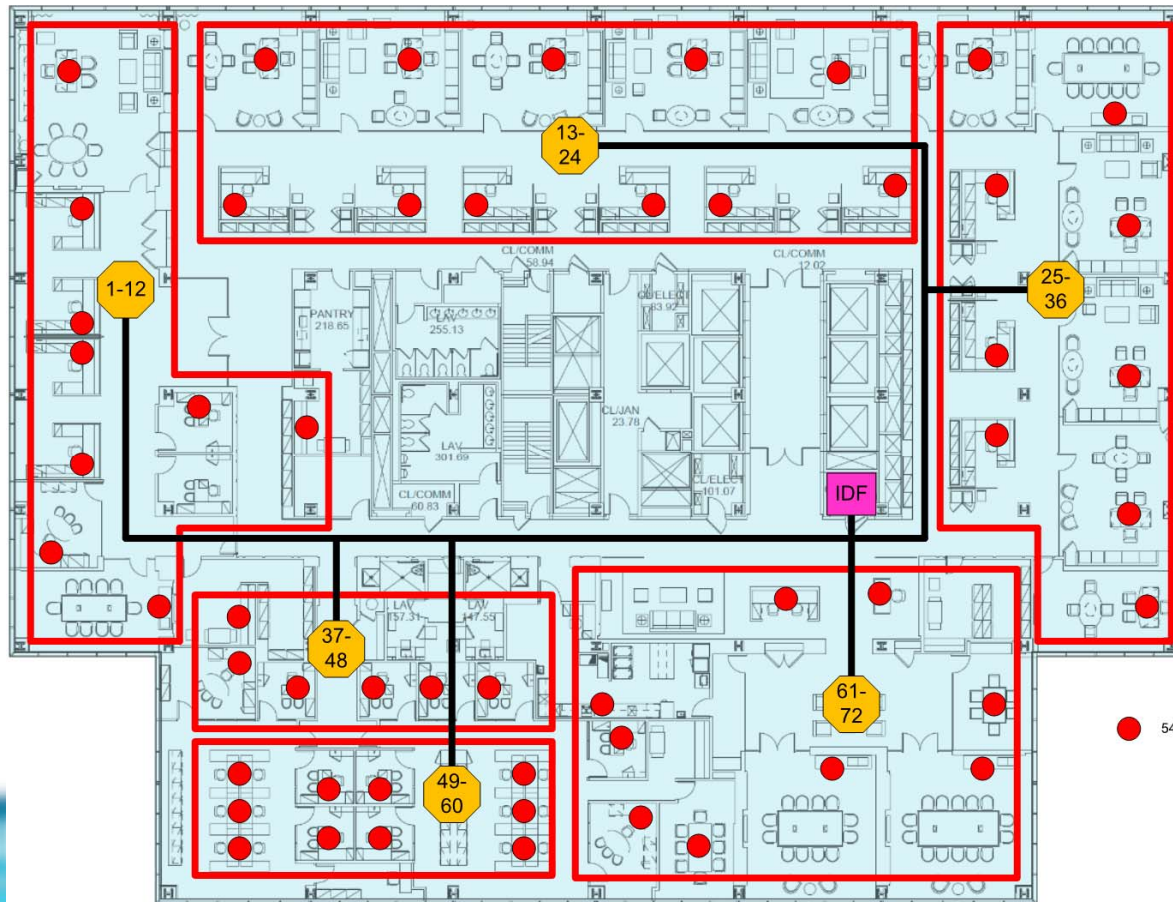

# Rack Scenario Answers

Area	Product Description	Total Qty
MDF	Rack Mount Fiber Enclosure, 2U, holds 6 MPO Fiber cassettes	1
MDF/IDF	MPO Fiber Cassette	8
IDF	Wall Mount 2-Post Open Frame Rack Cabinet 8U	4
IDF	Rack Mount Fiber Enclosure, 1U, holds 2 MPO Fiber cassettes	4
IDF	Rack Mount Fiber Enclosure, 2U, holds 6 Panels	4
IDF	SC Adapters, Simplex, APC, 12 F, Single-mode	10
Riser	MPO Fiber Trunk 12 Strand Singlemode Plenum (100 foot)	1
Riser	MPO Fiber Trunk 12 Strand Singlemode Plenum (200 foot)	1
Riser	MPO Fiber Trunk 12 Strand Singlemode Plenum (300 foot)	2
IDF	Rack Mounted 1 x 32 splitter	6
ONT Fiber	SCAPC-SCAPC Plenum Yellow 3 (10')	107
OLT Fiber	SCUPC-SCAPC Plenum Yellow 8 (25')	6
Horizontal	SCAPC-SCAPC Plenum Yellow 23 (75')	30
Horizontal	SCAPC-SCAPC Plenum Yellow 31 (100')	40
Horizontal	SCAPC-SCAPC Plenum Yellow 38 (125')	30
Horizontal	SCAPC-SCAPC Plenum Yellow 46 (150')	10
WAO	Faceplates 4-port White Alpine	107
WAO	SCAPC Singlemode adapter	107
WAO	Category 6 modular jack	37
WAO	RJ45 plug to RJ45 plug, T568B Blue	251

# Design Questions

- What design challenges do you see?
- What problems do you see POL solving?
- What problems do you see POL causing?

# Questions?

Passive Optical LAN Design



# 15 Minute Break



**Please respect others and return on time.**

# Passive Optical LAN Power Survivability

Chad Hines  
ITConnect, Inc.





# Section 6 Agenda

- Survivability
- Verticals
- Types
- Hardware and Cabling
- When, Where, and How
- Knowledge Check



# What is survivability

- Survivability: the capability of a system or organization to withstand a disaster or hostile environment, without significant impairment of its normal operations.

# Why Would We Need Survivability



# Power Over Ethernet Requirements

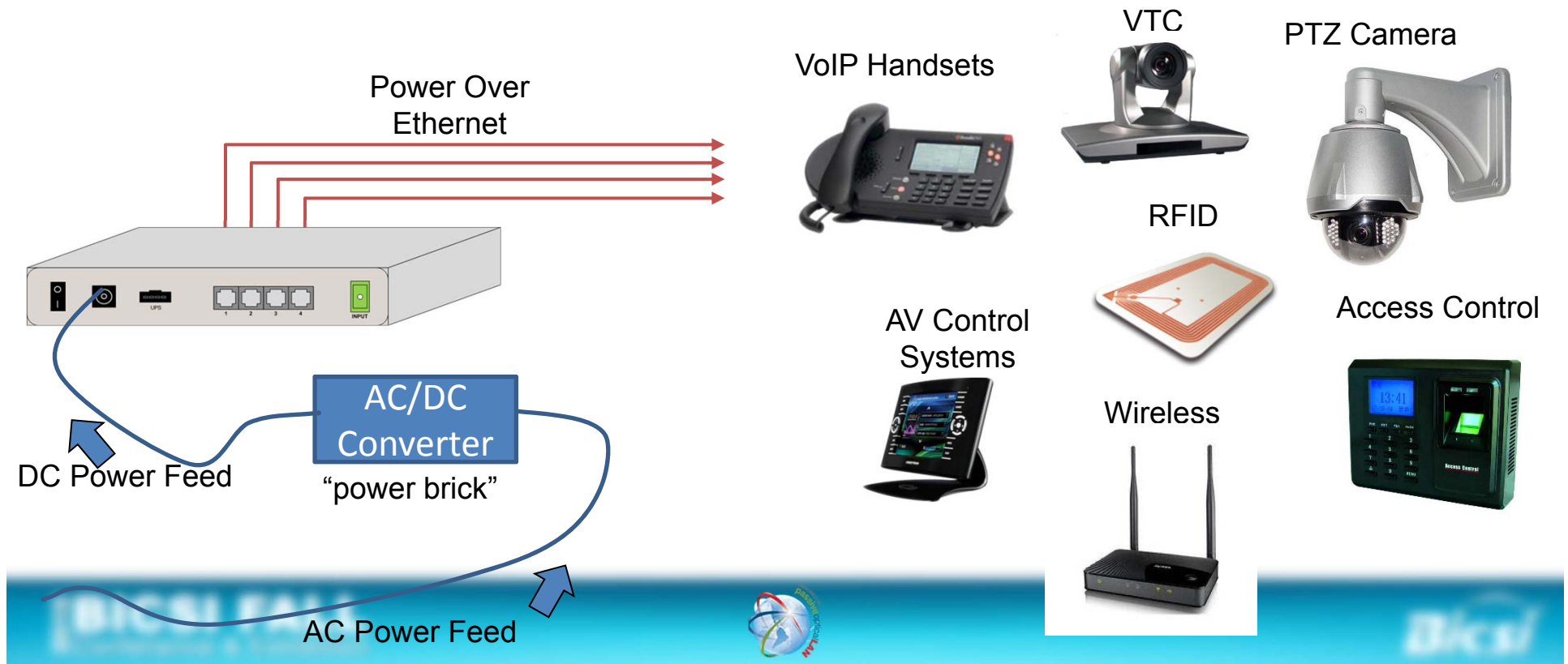

# Non-PoE Requirements

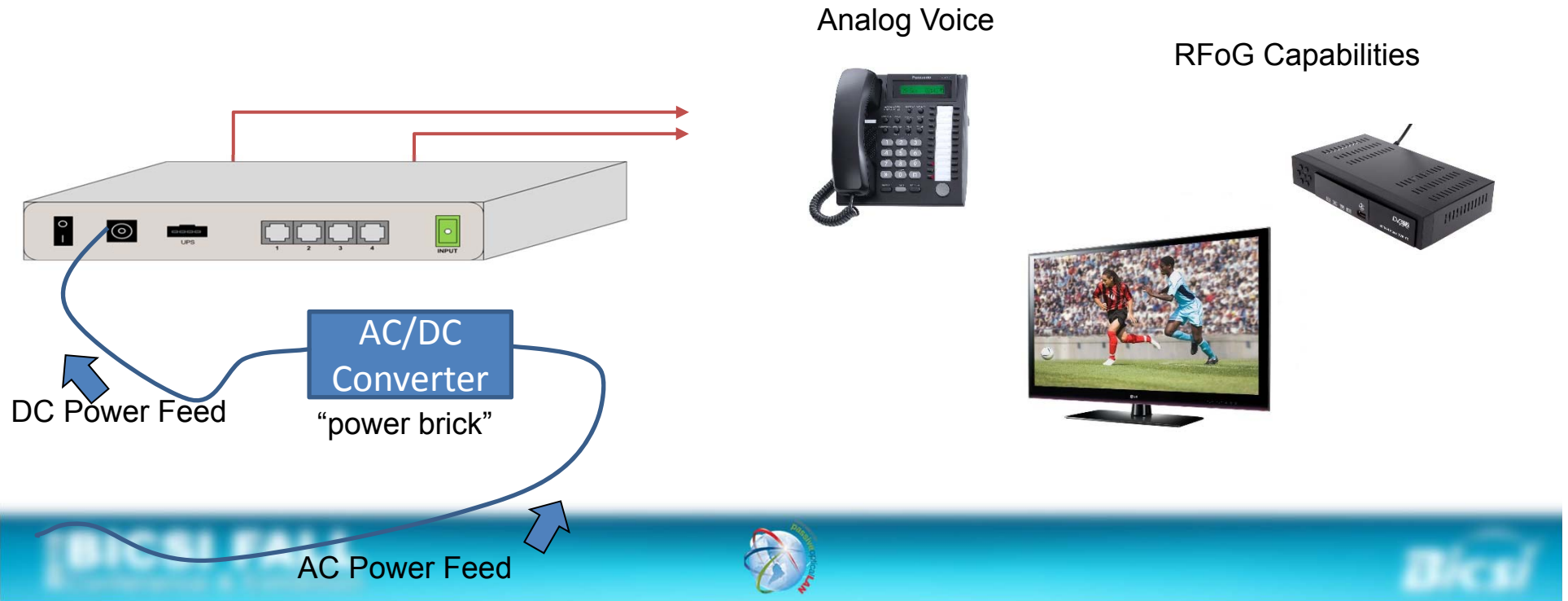

# What's The Impact



# ONT Placement Can Define Powering

AC = Local

DC = Remote



Wall-mount



Ceiling tile mount



Secure Wall Box



Wall Plate ONT



Wall Plate ONT



Under-desk mount



Desktop



# What Needs to Survive

VoIP Handsets



VTC



RFID

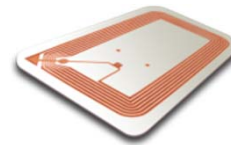

PTZ Camera



AV Control Systems



Wireless



Access Control





# Call Centers/ DoD/ Financial



# Healthcare





# Hospitality



# Commercial Business and Education



BCSI

# Different Ways to Survive

- Local battery
- Remote:
  - Powered
  - Battery
  - Generator
- AC power on generator  
“Emergency power”

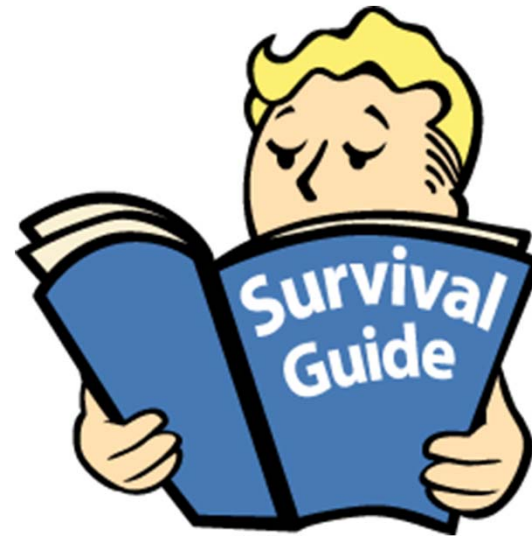

# Local Batteries



# Local Batteries

- PROs
  - Place them only where needed
  - Low cost/ commitment
  - May already be using UPS at desk
- CONs
  - Replacement after several years
  - More items to manage
  - Limited uptime
  - Battery failure

# Remote Power

- Remote power means to power multiple devices from a DC power station which can be either distributed or centralized.
  - Distributed remote power is typically located in an IDF or zone distribution box and can be remotely powered from a DC power plant from the MDF
  - Centralized remote power is typically in the MDF feeding localized power distribution units to feed ONT's
  - Voltage options: 48vdc – 54vdc



# Why Remote Line Power?



AC access not required at each ONT

Uses low cost copper cables



Battery backup provided in centralized location rather than at each ONT

CapEX  OpEX

Reduces CapEx and OpEx



Reduces time to market & enables rapid deployment

# Power Connectors

Locking preferred for remote power applications

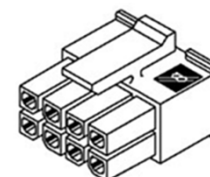

# Power Connectors

Non-locking connector  
introduces risk



# Power Connectors



Be  
creative  
but not  
sloppy



# 48vdc Centralized

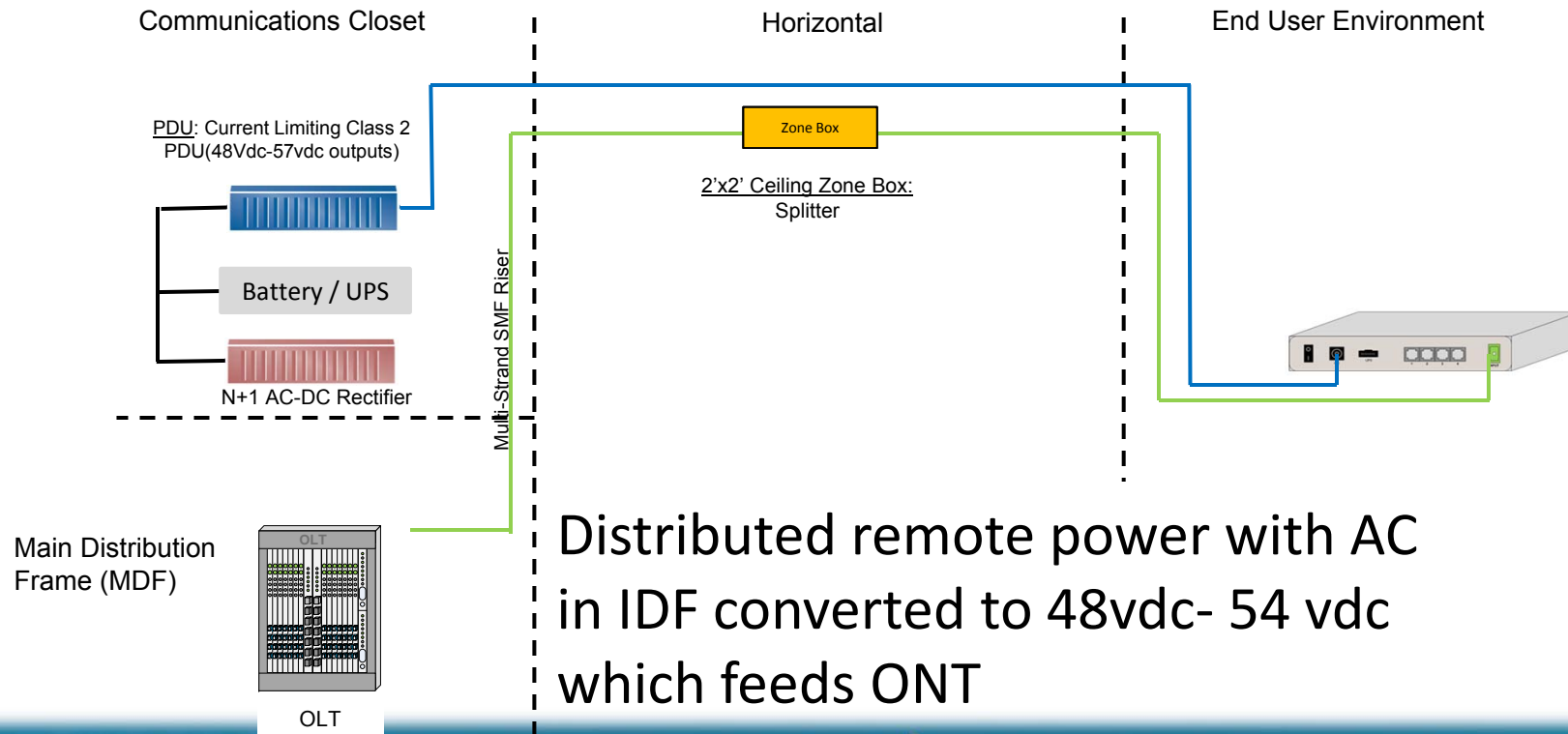

Distributed remote power with AC in IDF converted to 48vdc- 54 vdc which feeds OLT

# 48vdc Distributed

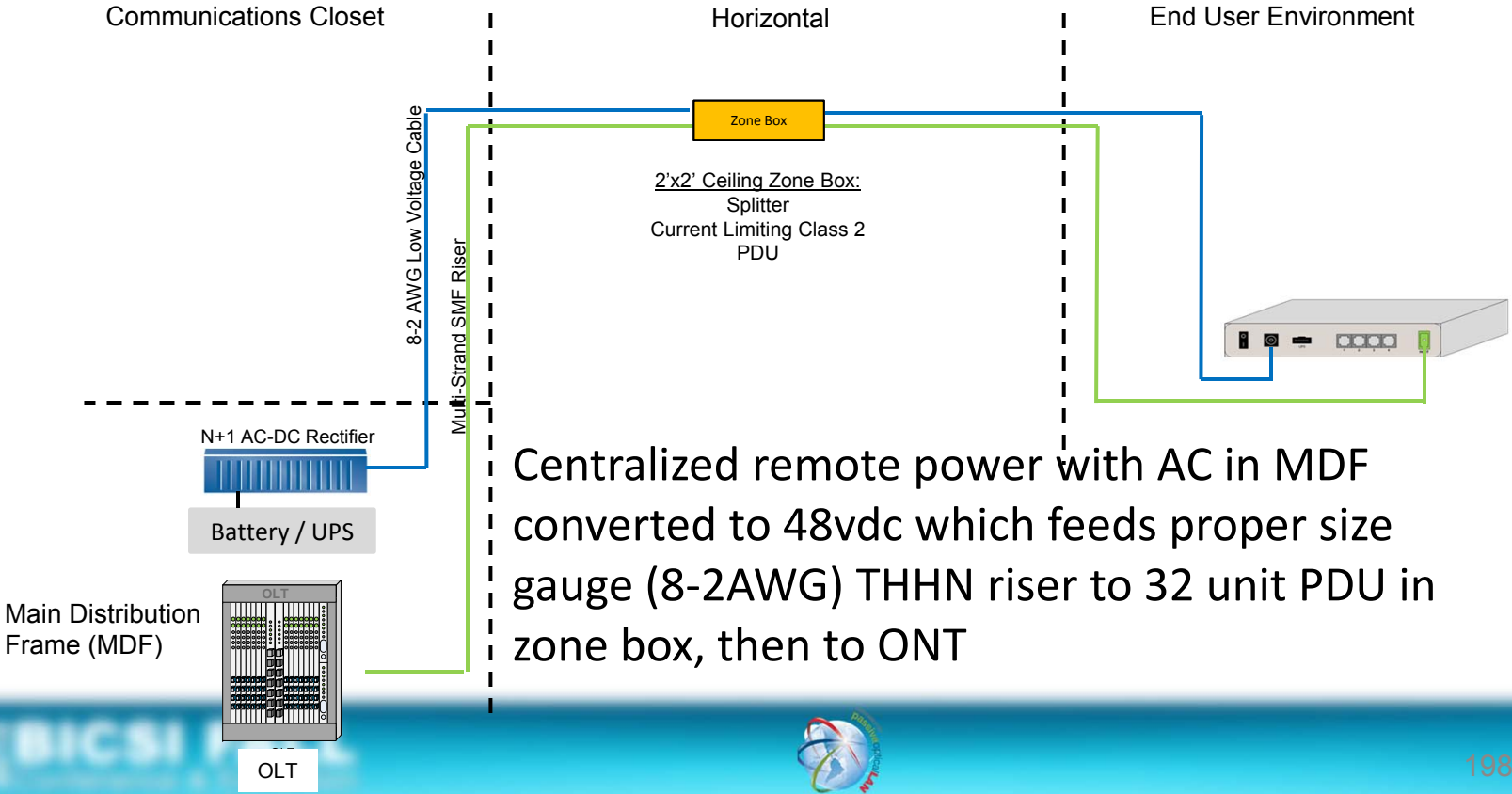

# Remote Power

- PROs
  - Survivability, battery back up can be sized to any customer requirement
  - Eliminates AC plug and wall wart at ONT
  - Centralizes battery backup
  - Remote power reset of an ONT and device
- CONs
  - Level 4 DC Technician
  - Power Engineer is required
  - Requires additional power in MDF
  - Electrical contractor will take a loss



# Cost Savings Summary

## Capex Savings

- Eliminating need to run AC power to each ONT location **reduces cost for cabling, conduits, and electricians**
- **Reduced space** required at each ONT
- NEC Class 2 system eliminates cost of using **armored cable** to comply with standards

## Opex Savings

- Eliminating batteries at remote sites reduces ongoing **battery maintenance** cost
- Remotely accessible system minimizes need for **site visits** for troubleshooting & alarming
- **Reduction in power consumption** through improved power conversion efficiency and lower HVAC requirements



# Remote Power Caution

- What happens when you have a coil of copper cable and send constant DC voltage through it?
- Trimming to avoid the coil means you've limited future flexibility
- Not all ONTs are 48vdc
- Certified UL/CSA Listed and NEBS class 2 certified product
- Consult a Certified DC Engineer for proper design

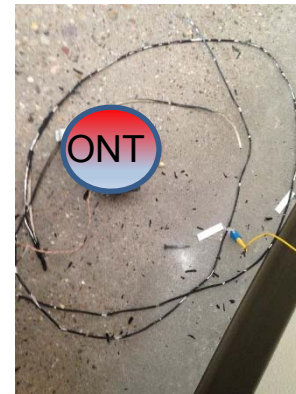
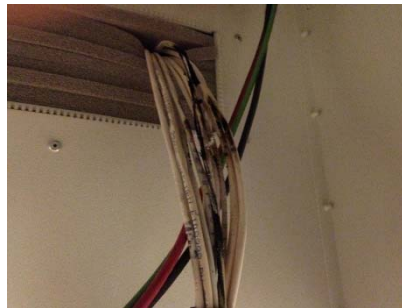

# AC Generator Power

- Alternating Current (AC) power
  - Installed on dedicated “emergency” circuits
  - Circuits fed from dedicated panels
  - Panels powered with dedicated feeders from generator power



# AC Generator Power

- PROs
  - Survivability
  - Not limited to run time of battery
- CONs
  - Added cost / complexity
  - Requires licensed electrician to install vs. low voltage contractor
  - Requires space outside of facility to house

# Rectifier Hardware Options

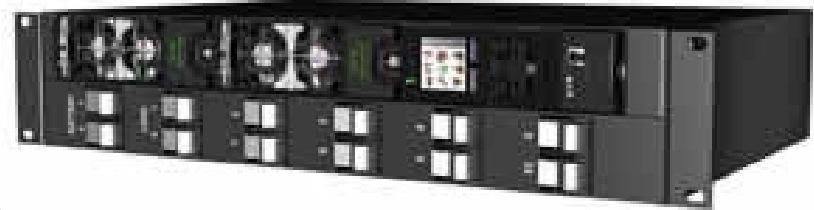

# PDU Hardware Options



# Cabling Options

- Solid vs. Stranded
- Hybrid composite cable
- Separate cables
- Use existing copper

# Solid vs. Stranded Conductor

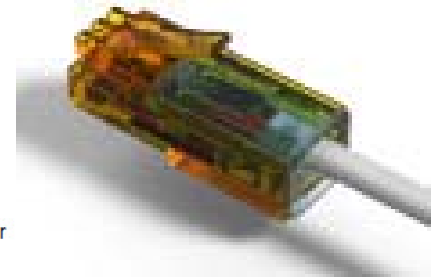
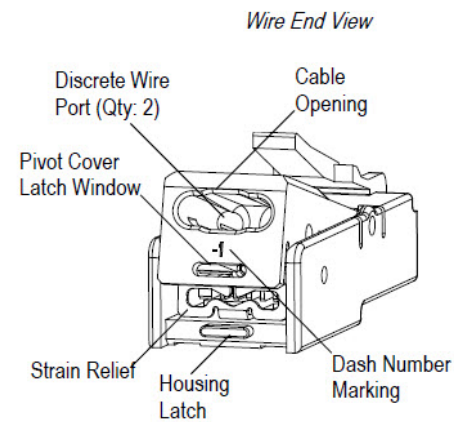
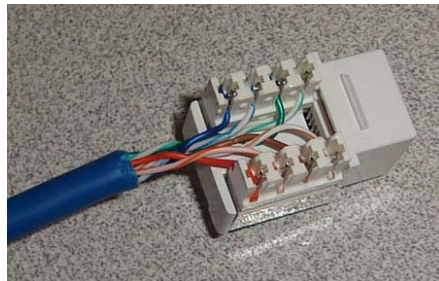

# Solid vs. Stranded Conductor

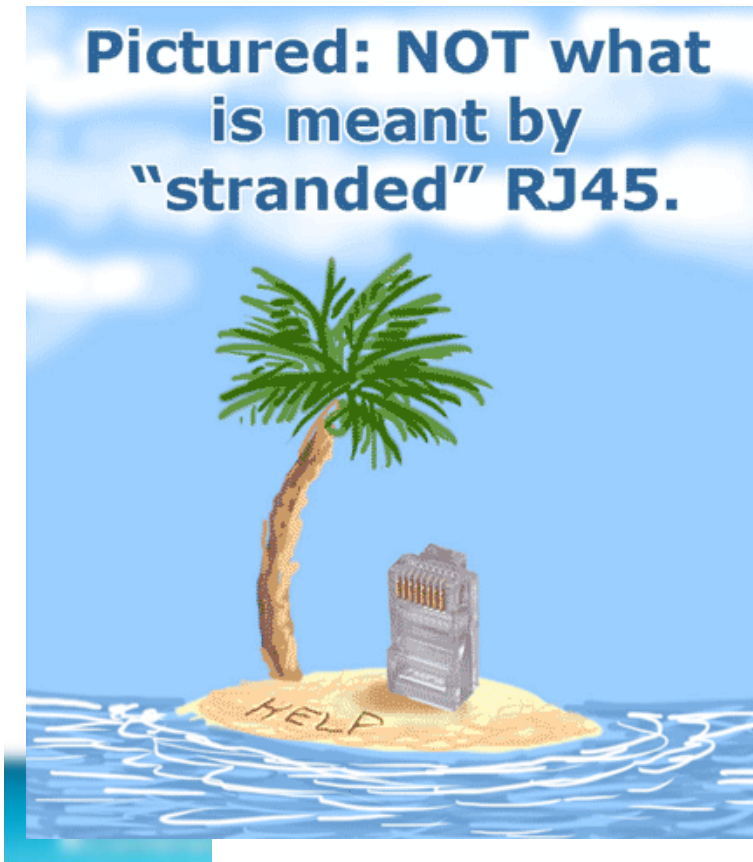

## Identifying Stranded VS. Solid RJ45s:

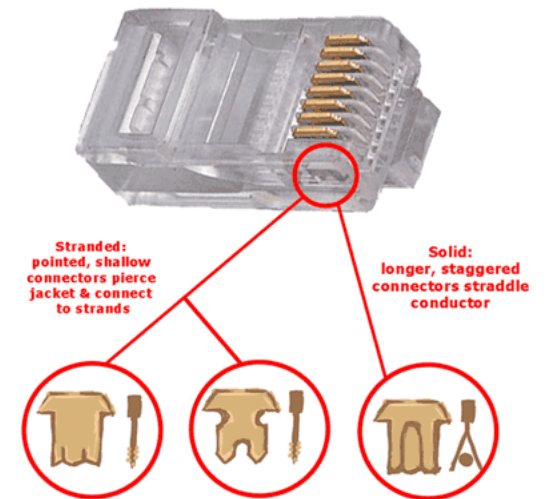



# Composite Cable

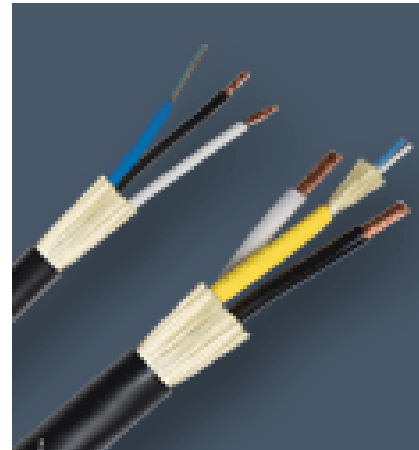
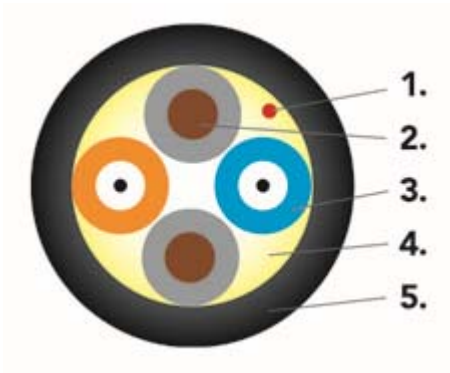

# Separate Cables



# Considerations for Cabling

- Will the copper and fiber originate in the same location? This will significantly impact your decision for Composite or Separate cables.
- Repurposing existing Cat-X cable as your power carrier is a benefit and reduces costs for cable and installation.

# Power System Design Process

## Step 1: Get the Numbers

- How many ONTs are required?
  - Per floor?
  - Per building?
  - Per sector?
- What is the rated power consumption of the ONTs?
- Will PoE+ be supplied by the ONT?

## Step 3: Consider Other Factors

- What is the desired runtime?
- Which circuits are considered Emergency circuits?
- What are future growth and expansion expectations?

## Step 2: Follow the Fiber Plan

- Where are the distribution points?
- Are IDF closets or electrical rooms available for power?
- What is the maximum distance from a distribution point to an ONT?

## Step 4: Determine Power Architecture

- Distributed DC Plants
- Centralized DC Plants

# How Far Can It Reach?

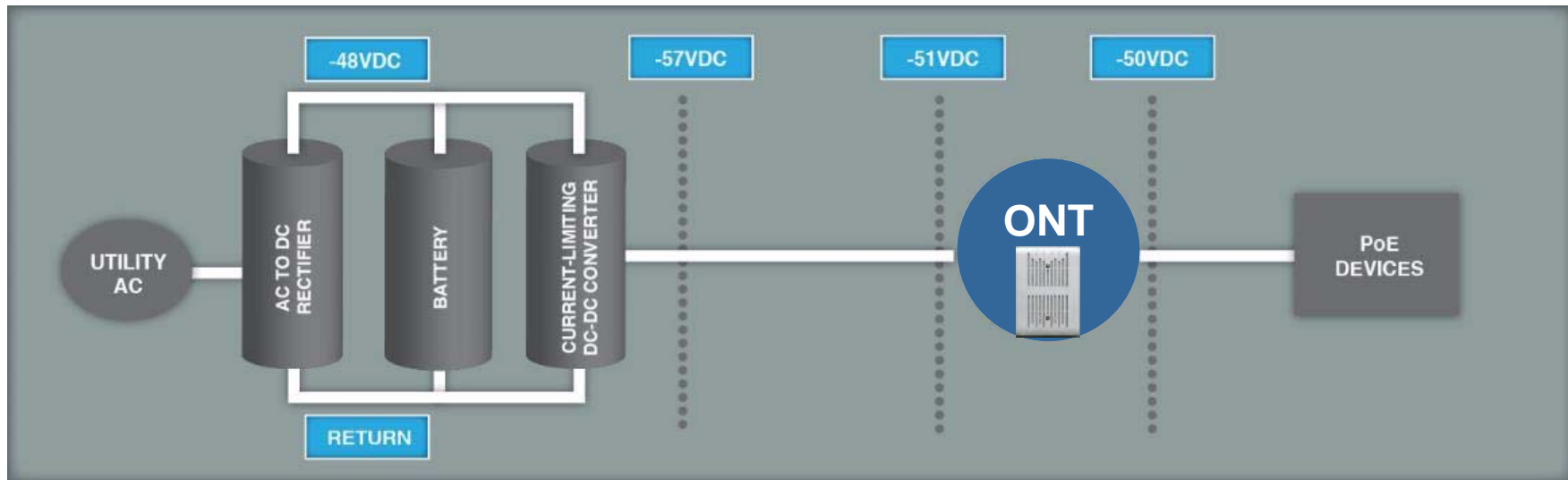

- **6Vdc** allowable voltage drop in cable to meet PoE+ standard at ONT
- 1Vdc drop across ONT

Max Distance to ONT Supporting PoE+					
Load (Watts)	Cable Gauge (AWG)				
	20	18	16	14	12
90	100	160	250	400	640
80	150	250	400	625	1000
70	175	275	450	725	1150
60	200	325	525	850	1350
50	250	400	625	1000	1600
40	300	500	800	1250	2050
30	400	650	1050	1700	2700

# Design Architecture: Centralized DC Plants

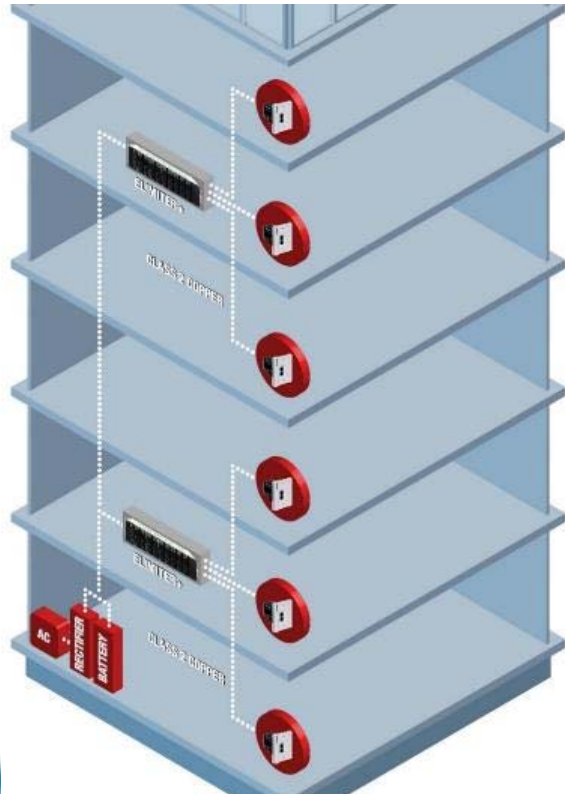

## Pros

- Single DC plant and batteries to maintain
- Less space per floor required for power equipment

## Cons

- Cabling cost to run Class 1 circuits to each Zone
  - Conduit
  - Electrician
  - Large AWG cable
- 48Vdc Plant and Battery must be larger to offset cable losses



## Design Architecture: Distributed DC Plants

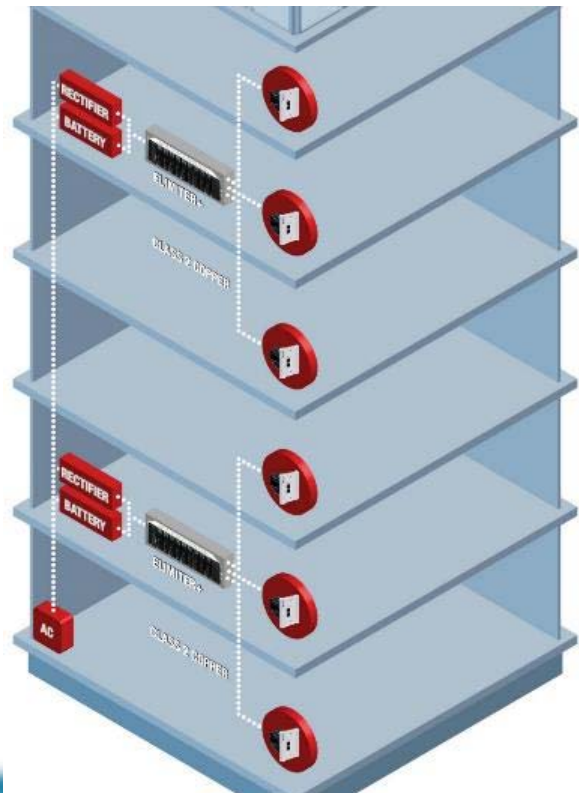

### Pros

- All DC cabling will be NEC Class 2 compliant
- Installation cost
- Equipment cost

### Cons

- Space must be found for power equipment in IDFs
- Distributed batteries are more difficult to maintain
- Additional AC circuits required to each rectifier location

# Design Example

ONT Count by IDF	1-2 Port ONT	DC WATTS	4 Port ONT	DC WATTS	8 Port ONT	DC WATTS	24 Port ONT (AC)	500W 120VAC	Total ONT	Total DC load	DC Power system Load	Total AC load (W)	# of Ch
IDF 3D	47	30	3	80	0	80	1	500	51	1650	2145	500	50
IDF MDF	47	30	7	80	0	80	1	500	55	1970	2561	500	54
IDF 3A	45	30	12	80	0	80	1	500	58	2310	3003	500	57
IDF 2F	48	30	10	80	2	80	1	500	61	2400	3120	500	60
IDF 2E	50	30	11	80	7	80	1	500	69	2940	3822	500	68
IDF 1A	58	30	21	80	0	80	1	500	80	3420	4446	500	79
IDF 2A	56	30	18	80	5	80	1	500	80	3520	4576	500	79
IDF 4A	62	30	24	80	0	80	1	500	87	3780	4914	500	86
IDF 2C	77	30	18	80	3	80	1	500	99	3990	5187	500	98
IDF 1Z	61	30	36	80	1	80	1	500	99	4790	6227	500	98
IDF 3C	76	30	34	80	1	80	1	500	112	5080	6604	500	111
IDF 5A	87	30	28	80	7	80	1	500	123	5410	7033	500	122
Total ONT	714		222		26		12		974	41260	53638	6000	962



# Deployment Methodologies

- What is the design architecture?
- What is the end user survivability requirement?
- Cabling and infrastructure approach
- Maintaining flexibility and future management in your network.



# Knowledge Check



**Does a 48VDC remote power system fed by an AC plug in require a licensed electrician for installation?**

A. Yes

✓ B. No

C. Sometimes

**Can a class 2 circuit be installed in plenum space without the use of conduit?**

**✓ A. Yes**

**B. No**

**C. Sometimes**

# Questions?

Power Survivability

Chad Hines  
ITConnect Inc.

BICSI FALL  
CONFERENCE & EXHIBITION



BicSI

# 90 Minute Lunch Break



**Please respect others and return on time.**

# POL Testing Considerations



Matt Miller

AECOM



# Fiber Connectors

SC/APC is default standard in PON networks

- APC connectors reduce reflectance
- Reduce damage to transmitters and amplifiers
- Allow injection of Analog Video



# APC and UPC

- Ultra Physical Contact Connectors (UPC)

- Blue



- Angled Physical Connectors (APC)

- Green



# Endface Comparison

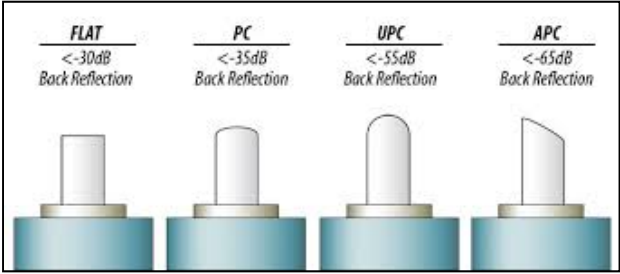
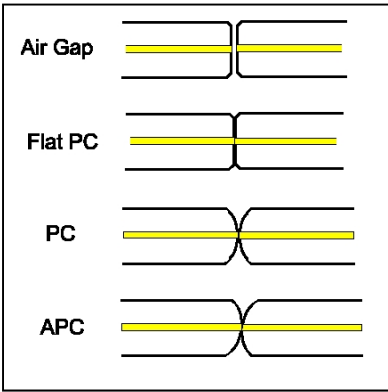
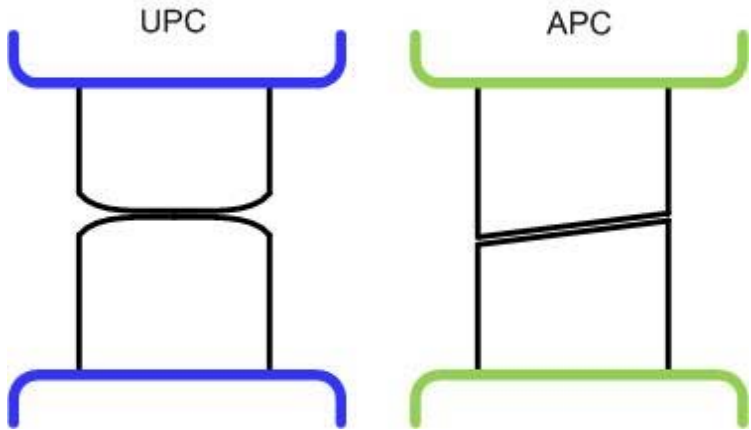

Source: FOA.ORG

# APC vs. PC (un-mated)

RL = ~14.7dB

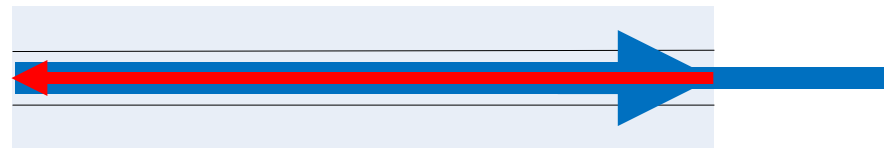

PC/UPC – Not Angled



RL = Return Loss

RL = >60dB

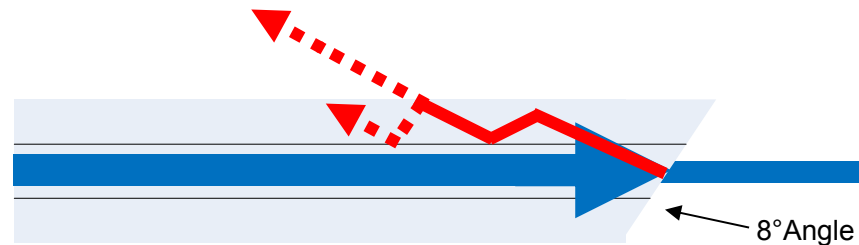

APC - Angled



# APC vs. PC (mated)

RL = ~ 50-55dB

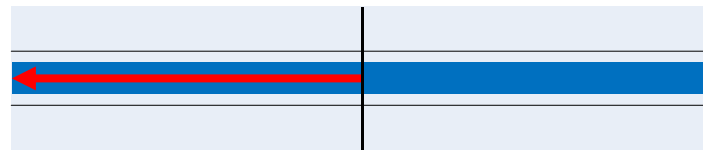

PC/UPC – Not Angled



RL = Return Loss

RL = >60dB

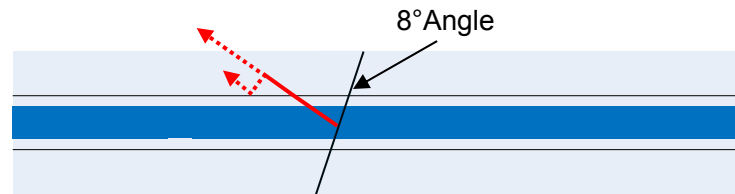

APC - Angled



# Importance of Cleaning

**No. 1** cause of fiber network failures is contaminated connectors

- NTT-Advanced Technology Research, 2010

---

**80% of network problems are due to dirty connectors!**

# Importance of Cleaning

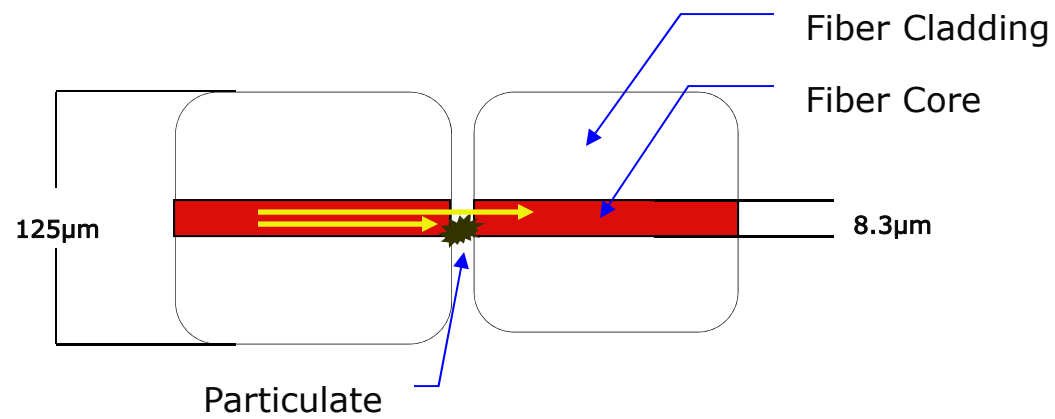

Information courtesy of USCONEC, Hickory, NC. Used with permission.

# Common Contaminants

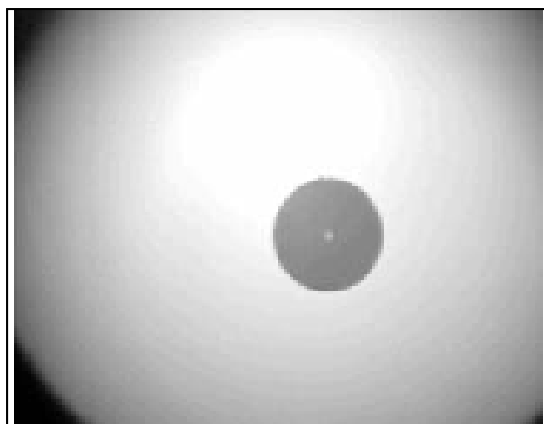

**SINGLEMODE FIBER**

End face should be free of any contamination or defects,

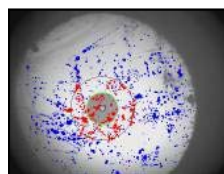

Dust Particles

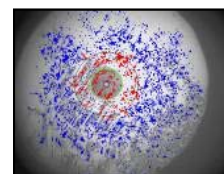

Hand Lotion

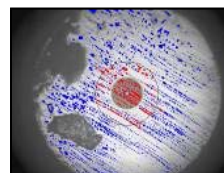

Finger Prints

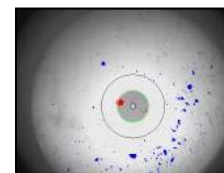

Alcohol Residue

- Dust
- Skin oil
- Alcohol residue
- Distilled water residue
- Vegetable oil
- Hand lotion
- Dryer lint
- Saltwater residue
- Graphite



Information courtesy of USCONEC and EXFO. Used with permission.



# Contaminate Transfers

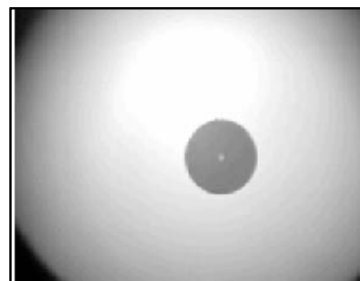

Clean ferrule

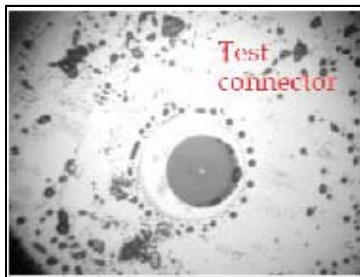

Contaminated ferrule

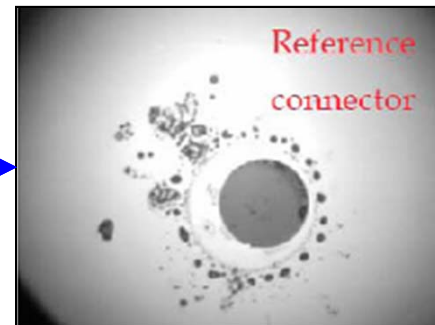

Contamination transfers from the contaminated to the clean ferrule reducing optical performance.

Information courtesy of USCONEC, Hickory, NC. Used with permission.





## And Migrates

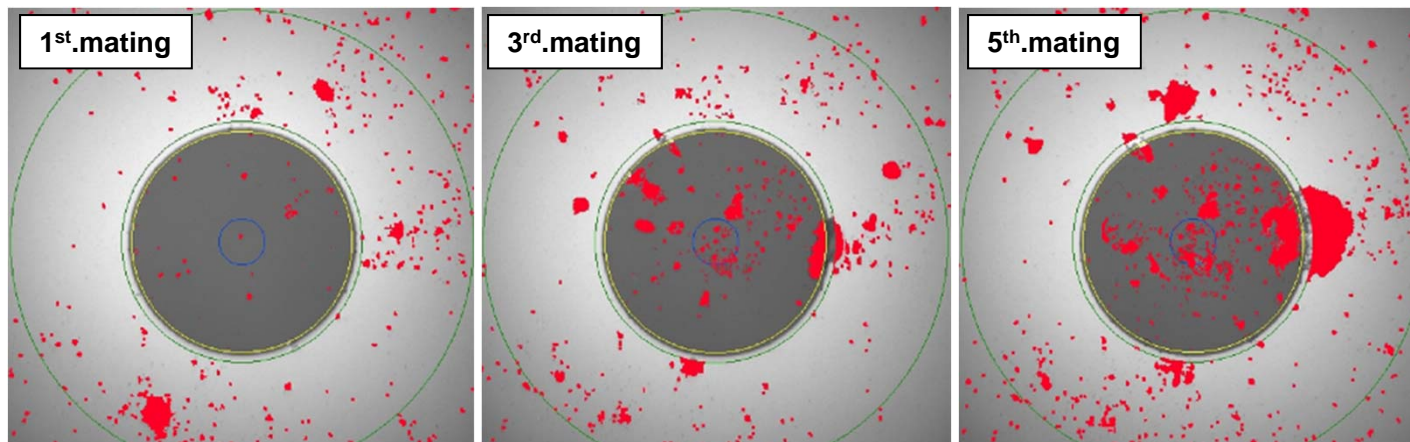

Dirt on connectors moves to the middle of the ferrule!!!

Source: IEC standard committee

# Testing

- Key is to verify cable plant performance and connectivity
- Splitters are passive, usually trouble free
- Look for issues at connectors and jumpers
- Be aware if disconnecting before a splitter, a number of users on the channel will lose service

# Testing

- Test in one direction. Light source at the OLT and power meter at the ONT locations.
- Ideally use a PON specific Light Source/Power Meter set to test 1310/1490/1550nm
- An alternate option is to use a standard Light Source/Power Meter at 1310nm and 1550nm
- OTDRs can be used for troubleshooting faults found in power meter testing, but are not used to certify links



# Testing

- Testing with splitters: 3dB loss for each 1:2 split (excludes connections)
- ANSI/TIA 568C.3 = max .75dB per mated pair
- Singlemode cable = 0.5dB/km
- Bend insensitive cable can be helpful

# Optical LAN Link Budget

- Max distance limited by attenuation, fiber loss. Splitters and connections contribute.
- Most budgets between 15.5 & 28dB; smaller splits and shorter cables require attenuators

Loss Contributor	GPON Budget
Splitter (1:32) =	16.7dB
Fiber Loss 10Km=	5dB
Conn/Splice Loss=	<u>3.6dB</u>
	25.3dB

Attenuation	Loss (Maximum)	Unit
Optical Loss 1310 nm	0.5	dB/Km
Optical Loss 1490 nm	0.5	dB/Km
Optical Loss 1550 nm	0.5	dB/Km
Splice Loss per unit	0.3	dB
Connector Loss	0.75	dB
1x32 PON Splitter	16.7	dB
1x16 PON Splitter	13.5	dB
1x8 PON Splitter	10.3	dB
1x4 PON Splitter	7.2	dB



# Centralized Split Test Layout (Downstream)

- Measure at 1310nm/1550nm
- Document admin/labeling scheme
- Less than 23dB = Pass\* (at points ② or ③)
- Paths on the same splitter should be uniform in loss

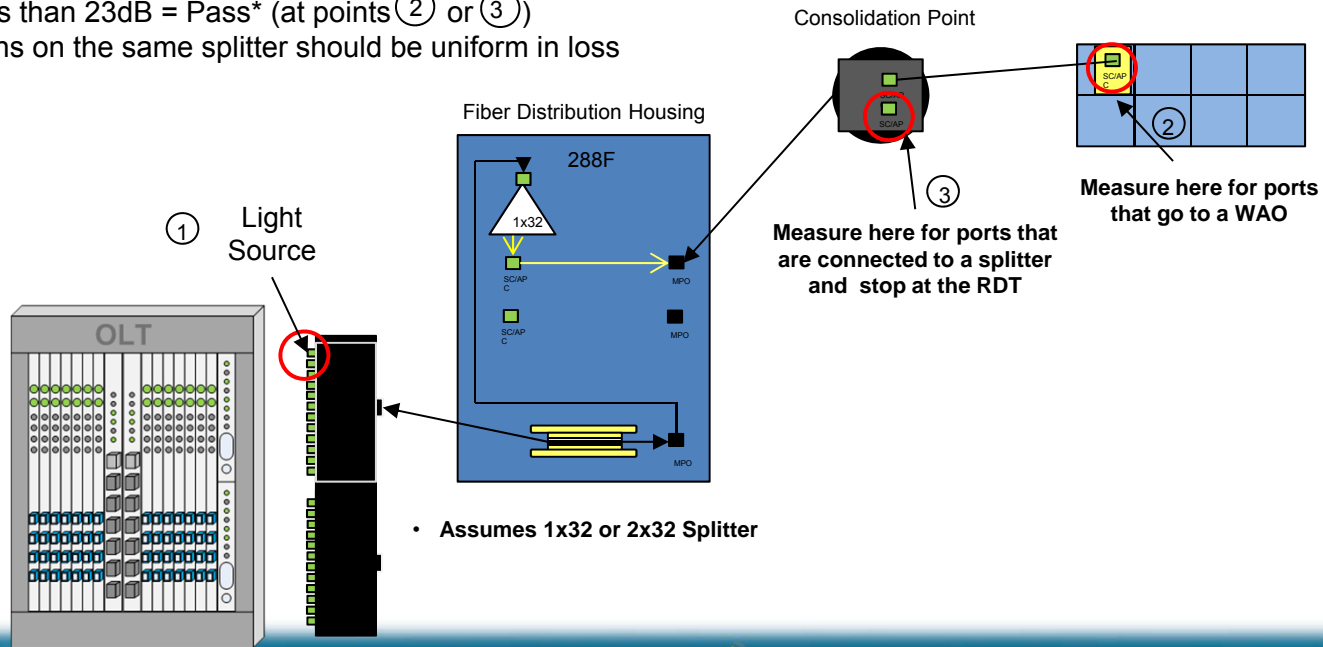

# Zone Split Test Layout (Downstream)

- Measure at 1310nm/1550nm
- Document admin/labeling scheme
- Less than 20dB = Pass\* (at points ② or ③)
- Paths on the same splitter should be uniform in loss

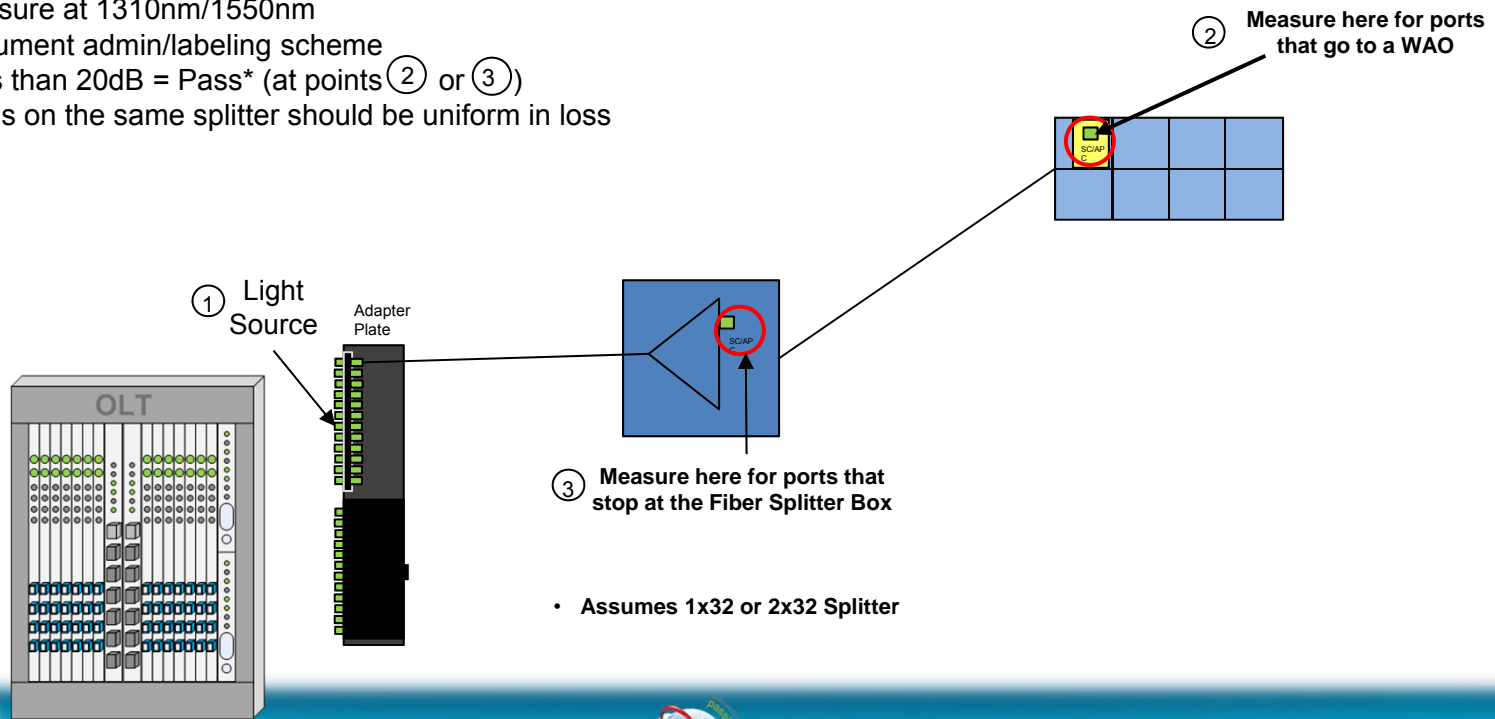

# Zone Split (Cascaded) Test Layout (Downstream)

- Measure at 1310nm/1550nm
- Document admin/labeling scheme
- Less than 21.5dB = Pass\* (at points ② or ③)
- Paths on the same splitter should be uniform in loss

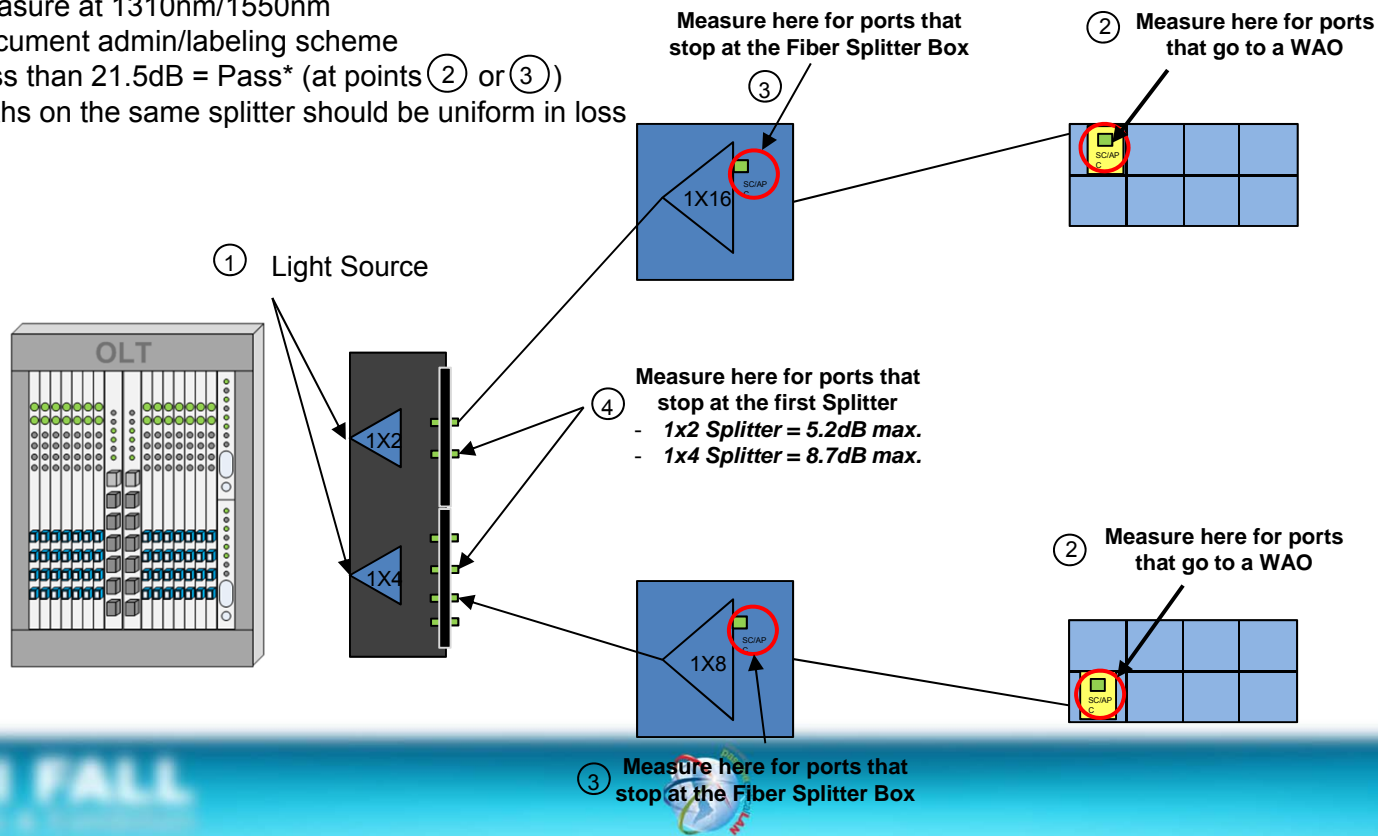



# Rack Mount Split Test Layout (Downstream)

- Measure at 1310nm/1550nm
- Document admin/labeling scheme
- Less than 19.75dB = Pass\* (at points ② or ③)
- Paths on the same splitter should be uniform in loss

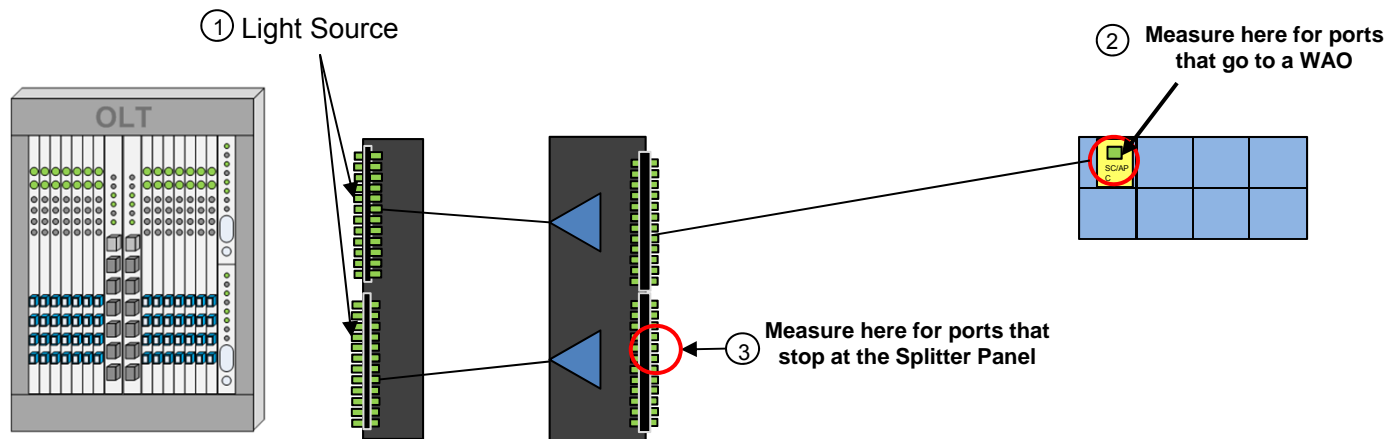

- Assumes 1x32 or 2x32 Splitter

# Hybrid PON/Traditional Test Layout (Downstream/Upstream)

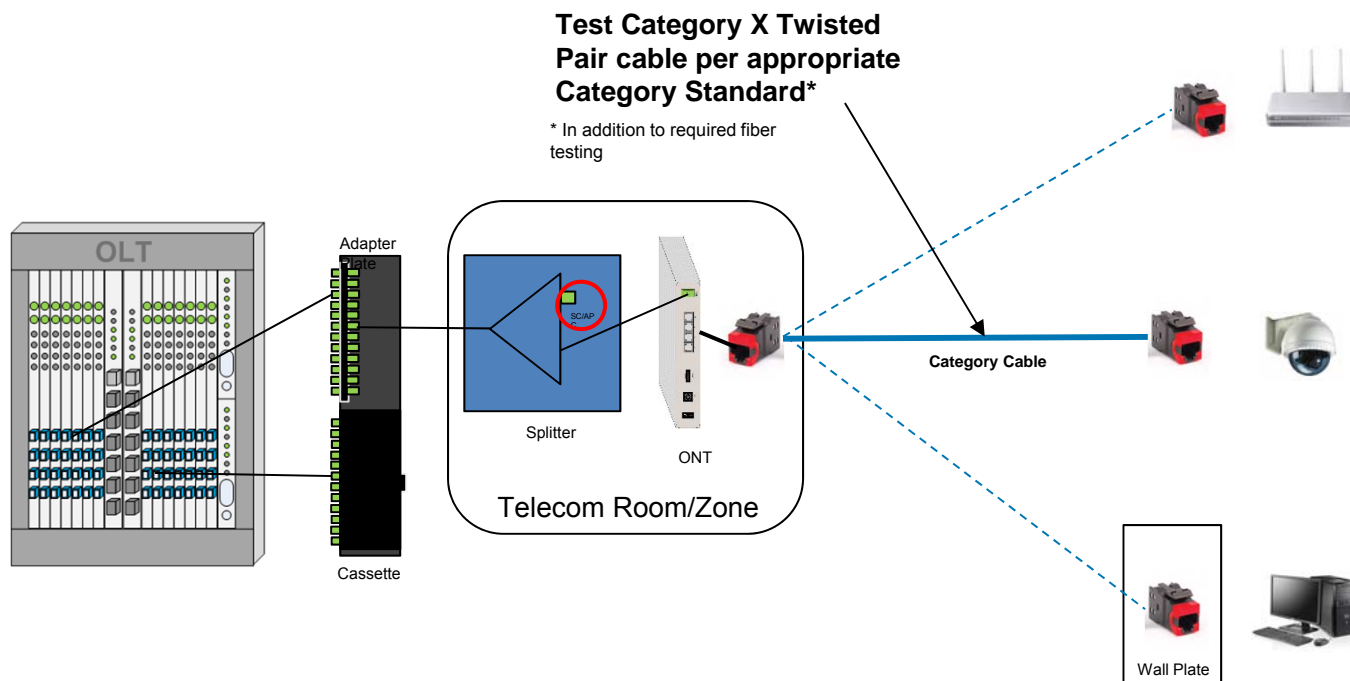

# Move, Add, Change (MAC) Testing

Once the splitter input connection is made to the OLT, it cannot be disconnected for testing of MACs without disruption to the other users. When a move, add, or change is made on an active PON circuit, verification must be made to ensure that the proper range of power in dBm will be fed to the ONT. There is a minimum and a maximum value that is acceptable per ITU G.984X. This is verified by placing the connector that will connect to the input of the ONT into an Optical Power Meter and measuring the power in dBm to verify that it is between the minimum and maximum level.

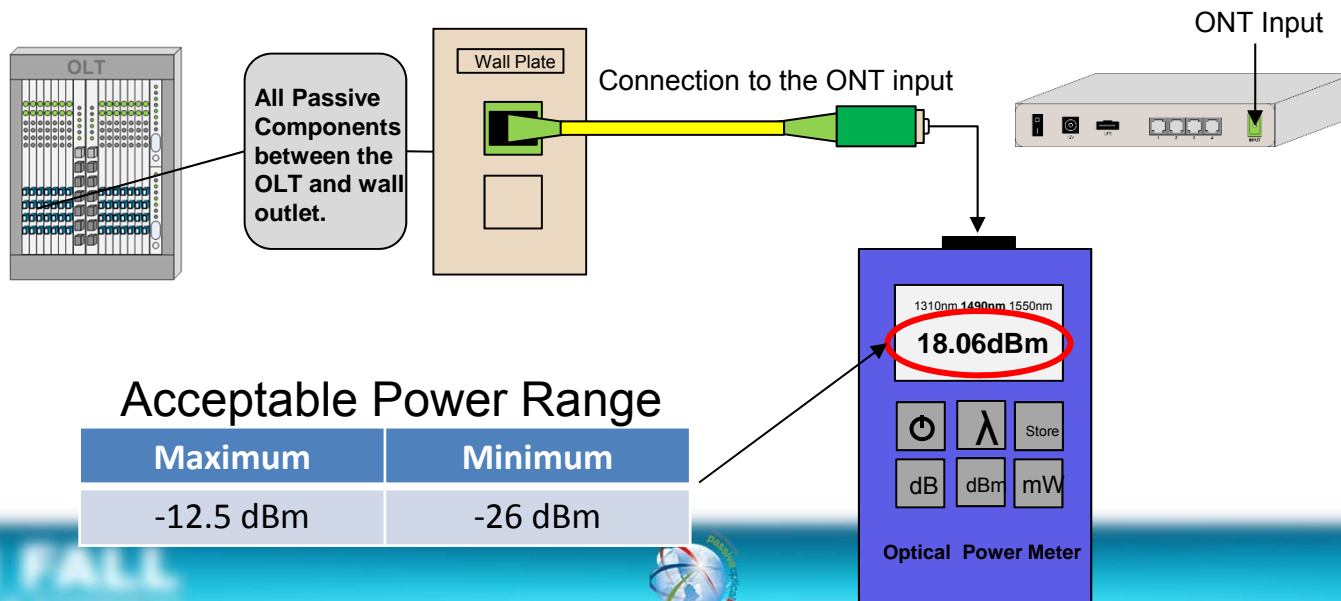

# Referencing the meter

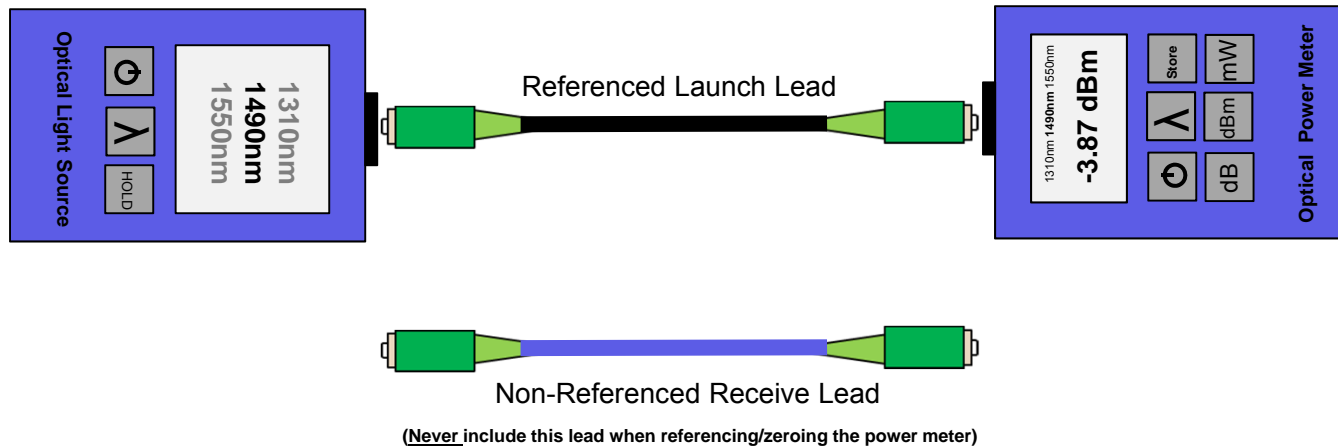

# Link Test with WAO

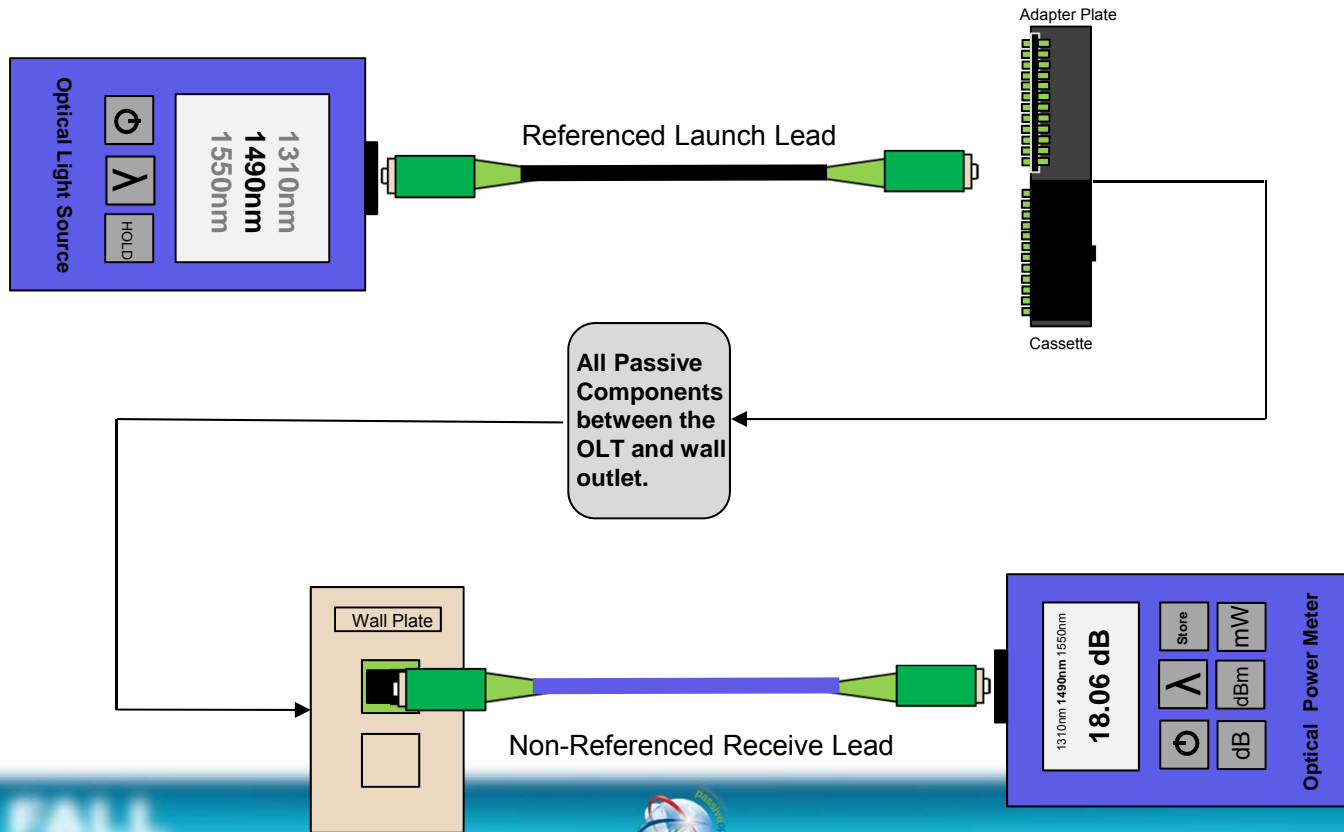

# Poke Through

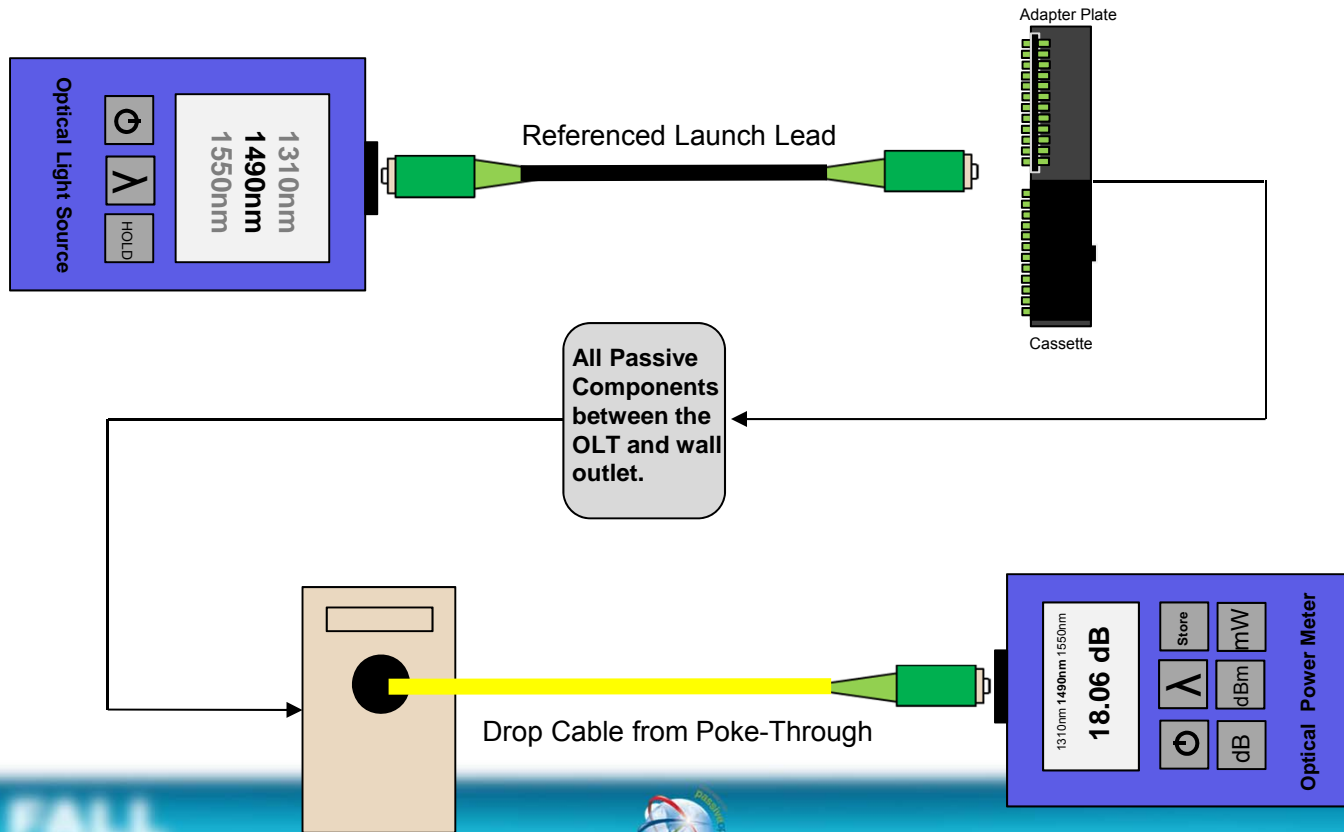

# Mid-Point Verification

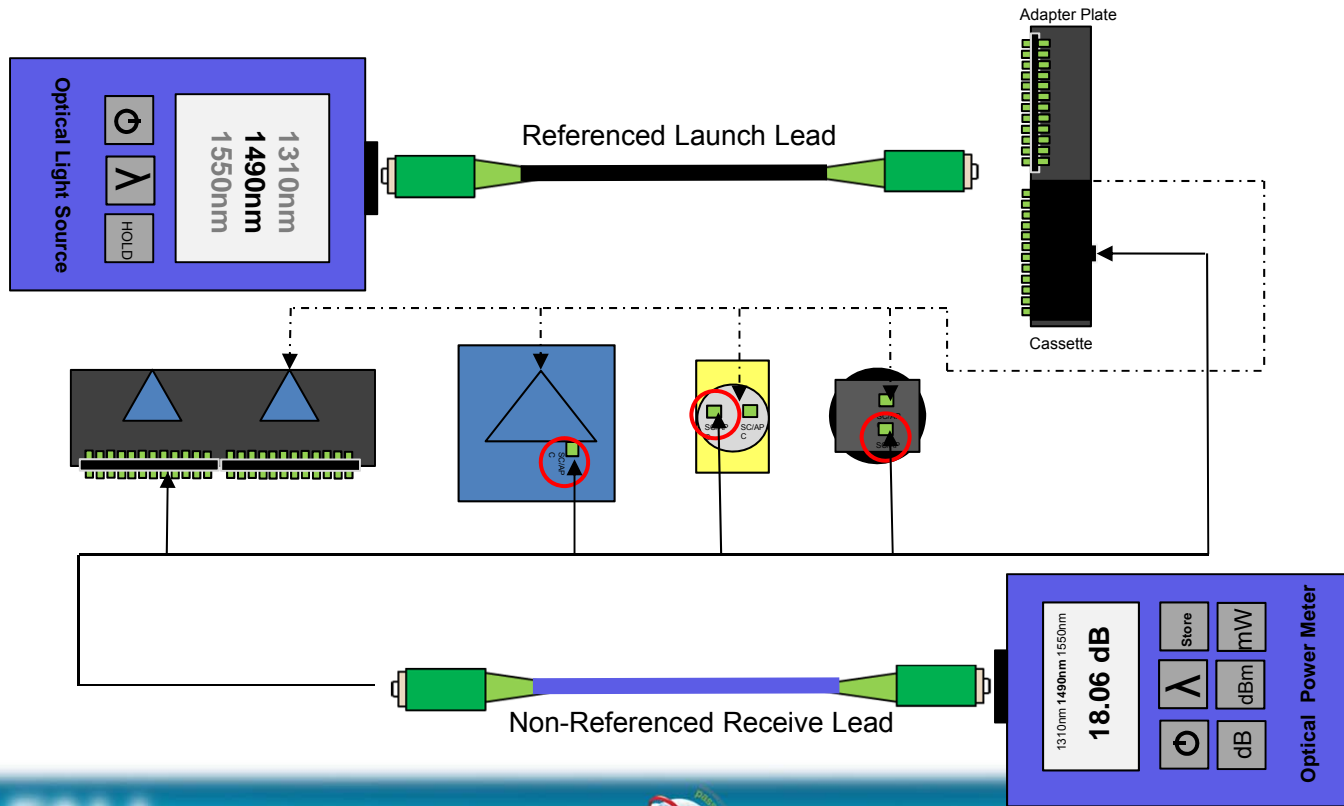

# Knowledge Check





**This is the common POL connector**

- ✓ A. SC/APC
- B. ST
- C. MT-RJ
- D. FC

# POL Networks use this fiber...

- A. Multimode
- ✓ B. Singlemode
- C. Unimode
- D. OM3

**It is important to ensure connector endfaces are clean prior to mating**

- ✓ A. True
- B. False

**Contaminate on fiber connectors can**

A. Transfer

B. Migrate

C. Block light

✓ D. All of the above

**You should always use a wet cleaning method to remove contamination**

A. True

✓ B. False

**A reduction of 3dB of light signal reduces the received power by...**

A. 10%

✓ B. Half

C. 12 Volts

**When testing a POL with an OTDR, you should test in this direction...**

- ✓ A. Upstream**
- B. Downstream**
- C. Sideways**

Loss budgets should be determined by advertised  
“Typical” performance values

A. True

✓ B. False



# Questions?

## POL Testing Considerations

Matt Miller

AECOM

# Passive Optical LAN Integration & Management



Matt Miller

AECOM

BICSI FALL



BicSI

# Agenda

- PON Communications
- ONT Ranging Process
- RF Video Injection
- Centralized Administration
  - Management Server vs CLI
- Templates & Profiles
- VLAN Creation
- Uplink Provisioning
  - Link Aggregation Groups
- ONT Deployment & Discovery
- ONT Provisioning
  - FSAN Type B Protection
- Bandwidth Calculations & Assignment
- Traffic Flow
- Tagging, LLDP, PoE, QoS
- STP & Loop Detection
- Multicast

# Objectives

After successfully completing this course, you should be able to:

- Understand the differences between ITU and IEEE PON Standards
- Describe the ONT ranging and provisioning process
- Understand the basic steps for deploying a POL
- Understand the future PON standards

# Standards – IEEE vs. ITU

- ITU and IEEE have separate standards for PON
- Both standards use the same passive infrastructure (fiber & splitters)
- The primary difference is the electronics

# Popular Standards Comparison

	EPON	GPON
Standard	IEEE 802.3ah	ITU G.984
Speed	1Gbps Symmetrical	2.4Gbps Down / 1.2 Gbps Up
Framing	Ethernet (mostly native)	GEMS Encapsulation
Wavelengths	1490nm/1310nm	1490nm/1310nm
Dynamic Bandwidth	Optional Vendor Specific	Built-in
Encryption	Optional Vendor Specific	AES-128 Downstream

# Standards Timeline

## IEEE

## ITU

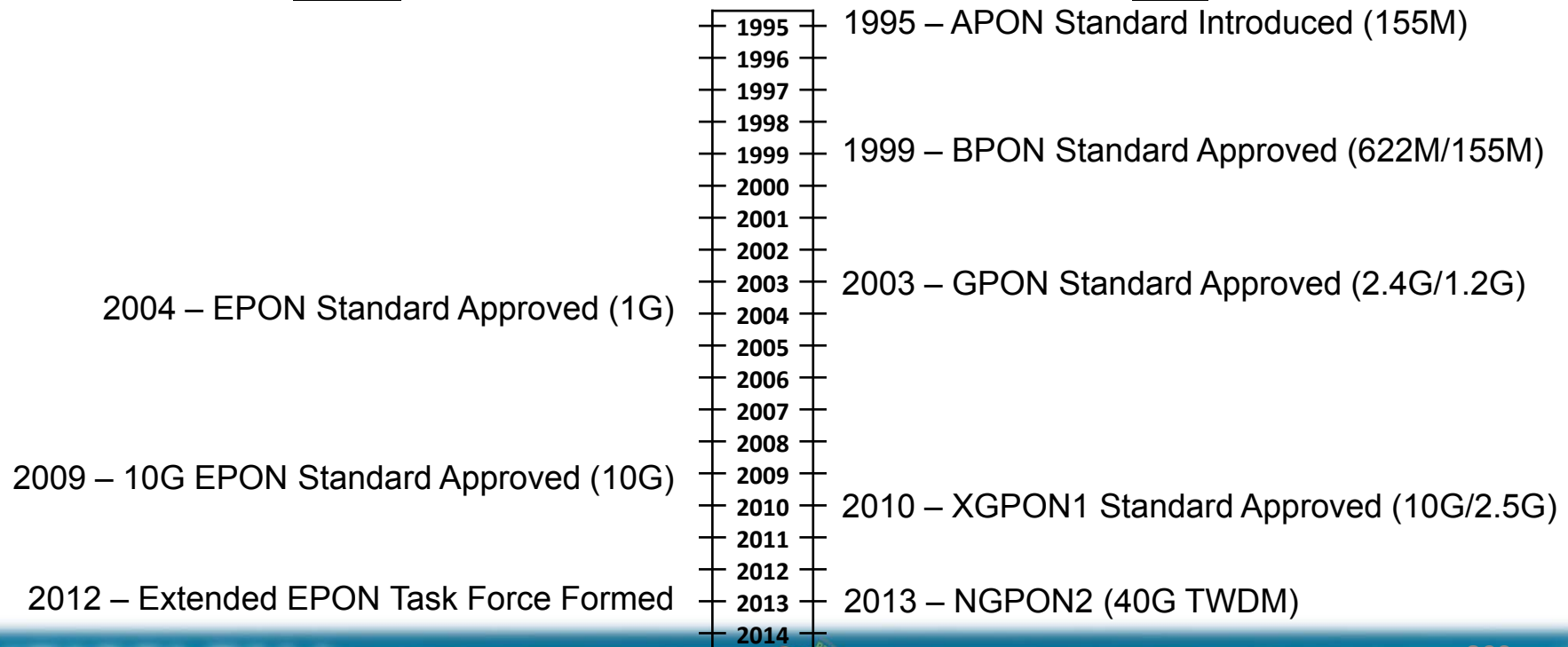

# WDM Methodology

- Multiple wavelengths over the same physical strand of glass
- Wavelengths do not interfere with each other
- Allows multiple discreet communications

**wavelength-division multiplexing (WDM)**

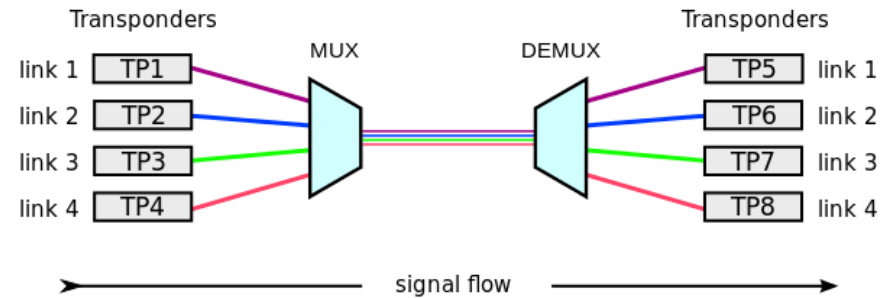

"WDM operating principle" by Xens - Own work. Licensed under Creative Commons Attribution-Share Alike 3.0 via Wikimedia Commons - [http://commons.wikimedia.org/wiki/File:WDM\\_operating\\_principle.svg#mediaviewer/File:WDM\\_operating\\_principle.svg](http://commons.wikimedia.org/wiki/File:WDM_operating_principle.svg#mediaviewer/File:WDM_operating_principle.svg)



# WDM in PON

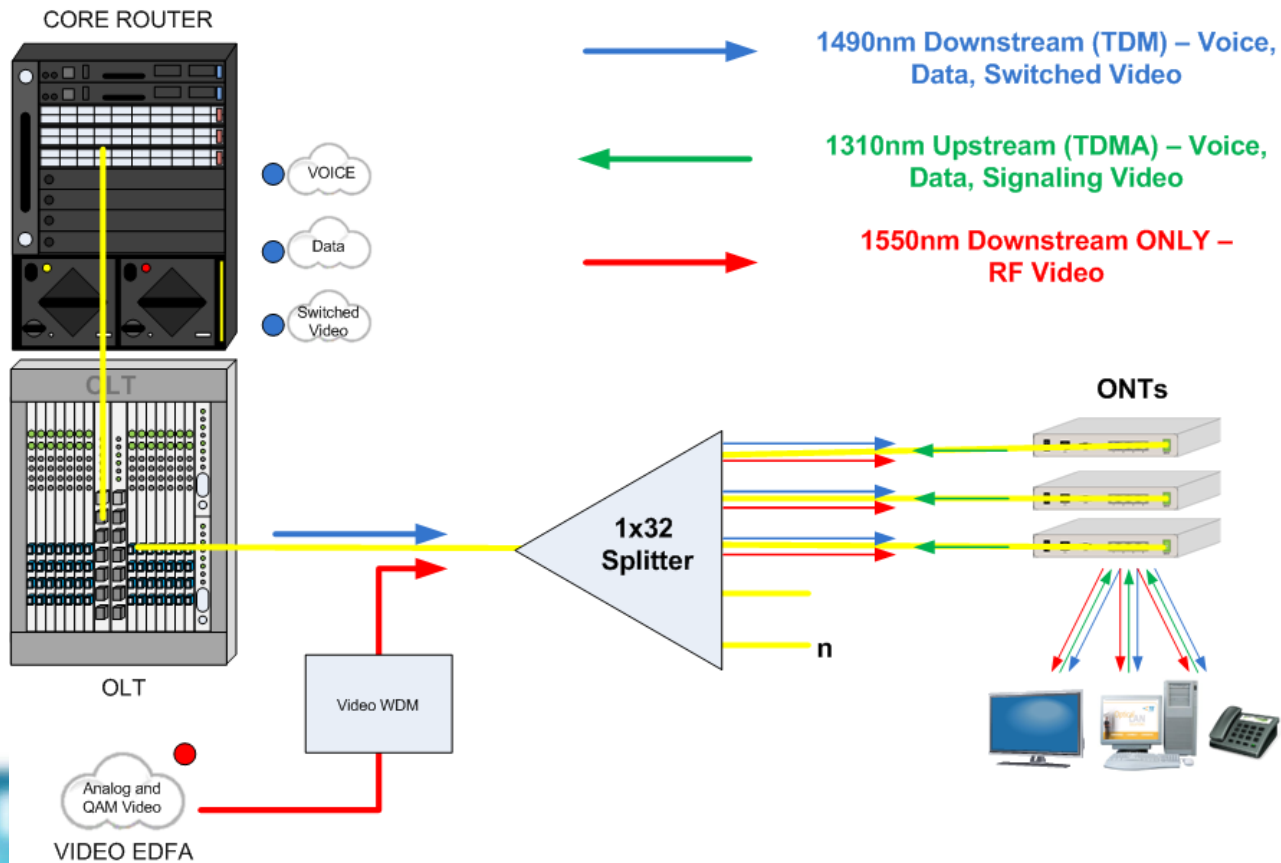

# PON Types

- **BPON – (Broadband PON)** is an older version of PON technology which is based on ITU specifications and is characterized by an asymmetrical 622 Mbps downstream and a 155 Mbps upstream optical line rate. Earlier versions of Verizon's FiOS™ offering in the U.S. are based on BPON but more recent implementations of FiOS use GPON technology.
- **GPON – (Gigabit PON)** is the latest ITU specified PON network and is characterized by a 2.4 Gbps downstream and a 1.25 Gbps upstream optical line rate. The first significant commercial deployments of GPON began in early 2008. Most carrier implementations of GPON are in the U.S. however it is beginning to proliferate in European markets as well.
- **EPON – (Gigabit Ethernet PON or GEAPON)** is an IEEE standards based PON system characterized by a symmetrical 1.25 Gbps optical line rate. EPON is the predominant PON solution since it has been commercially available since 2001. GEAPON has been primarily deployed in Asian Pacific markets. Recently, 10Gbit/s EPON or 10G-EPON was ratified as an amendment (IEEE 802.3av) in the IEEE 802.3 standard and provides for an asymmetrical 10 Gbps downstream/1 Gbps upstream rate as well as a symmetrical 10 Gbps rate.
- **WDM PON – (Wave Division Multiplexing PON)** is an emerging technology which leverages the optical advances of dense wave division multiplexing (DWDM) to provide a dedicated wavelength to a single ONT. Implementations range from “tunable” optics which must be matched to the ONT's optics to a dynamic optical locking capability which automatically assigns a wavelength to the ONT at the ranging phase. WDM PONs utilize an arrayed waveguide grating (AWG) to multiplex up to 32 wavelengths of light onto a single fiber in the same way a passive optical splitter does. Unlike a typical optical splitter however, an AWG utilizes a phase shift in the optical light to provide an output on each fiber that only receives a certain wavelength of light.



# Downstream Communication

The OLT transmits a signal downstream that all of the ONTs receive (point-to-multipoint). In the downstream direction, the information is broadcast on a specific color (wavelength) of laser light. The information is encoded into digital form and given a specific address that matches a specific ONT. The ONT that matches the address receives the signal and forwards the information to the end-user Ethernet port as depicted below.

## Downstream Broadcast

All data goes to all ONTs and the ONT address controls the output data

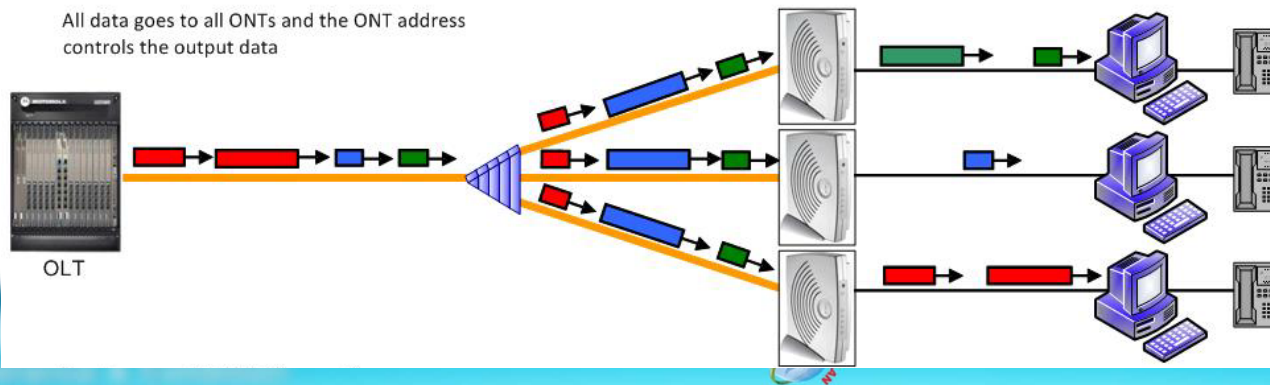

# Upstream Communication

Since many ONTs are placed on the same fiber, each with their own laser, upstream communications must be coordinated so that they do not interfere with each other. This is done by synchronizing the ONTs and requiring each to send information to the OLT (Upstream) in a specific time window (TDM). The upstream laser color is different from the downstream laser, so the upstream signal will not interfere with other ONTs on the PON. Using the WDM technique, ONTs do not interfere with each other; the upstream signals do not interfere with downstream signals, and the upstream and downstream signals can communicate at the same time (full duplex). This mechanism for converged, duplex communication is depicted below.

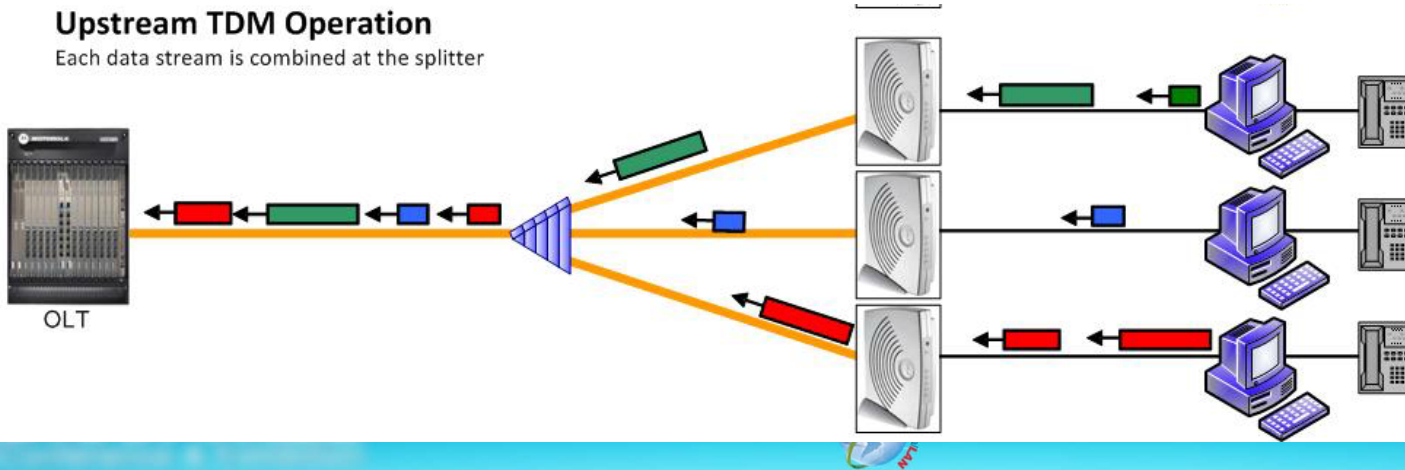

# GPON Bandwidth

- GPON upstream bandwidth is directly correlated to TDMA time slot
- Each ONT will get a number of timeslots allocated. Each frame is 125 $\mu$ s in length
  
- Static bandwidth management
- Dynamic Bandwidth Allocation (DBA)
  - DBA is specified in ITU 984.3. This feature is used to grant upstream bandwidth to ONUs based on their demand
  - Used for oversubscribing GPON links

# ONT Ranging Process

1. Authorize ONT to be on the PON
2. Determine distance from OLT
3. Setup OMCI communications
4. Assign bandwidth timeslots
5. Upgrade ONT software
6. Assign VLANs, QoS, PoE, security, etc.

# RF Video

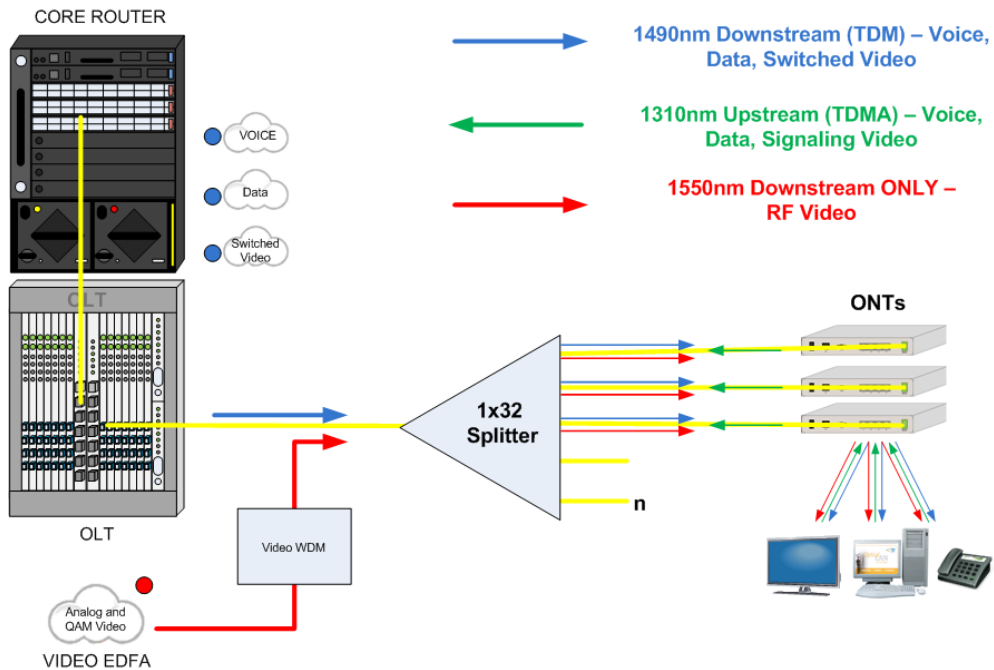

Additionally, an analog signal can be injected onto the same PON fiber, using yet another color of light (WDM techniques). This is called an overlay and is generally used to carry broadcast TV to the user's location. As with data and voice propagation, the light is a different color and therefore does not interfere with the other signals being carried on the fiber cable.

# RF Video

1. Video Source (Coax)
2. Laser Transmitter
3. Erbium Doped Fiber Amplifier (EDFA)
4. WDM

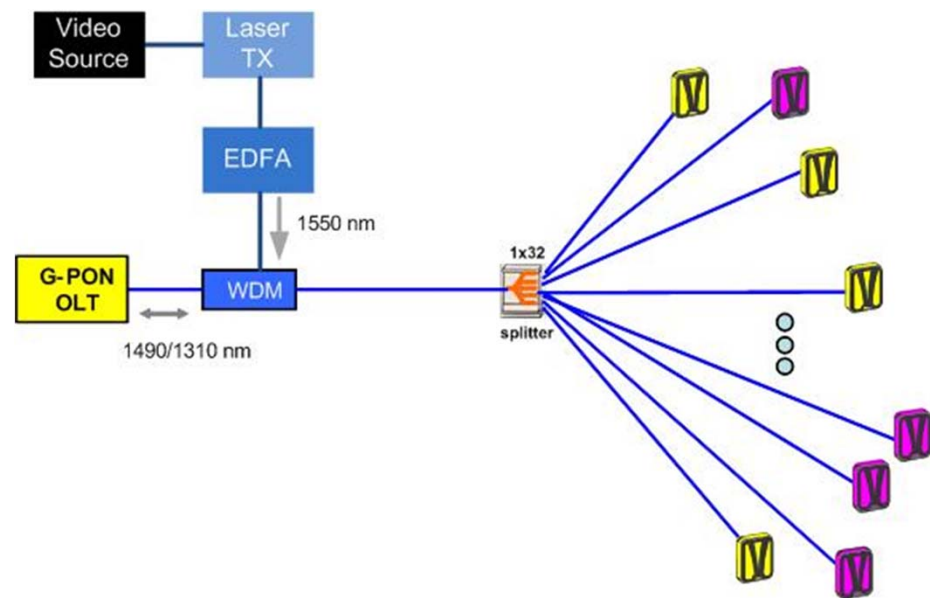



# Centralized Administration

- Reduce Operations & Maintenance (O&M) by reduced the amount of equipment managed
  - ONTs are managed by the OLT
- No powered devices in the middle of the network
  - Same location as user
- Co-locate OLT with other IT gear
  - Same location as other gear
- OLT handles activation, administration, and provision
- No administration ports on ONTs

# 15 Minute Break



**Please respect others and return on time.**

# Knowledge Check

- What is a VLAN?
- Difference between Layers 1, 2 and 3
- Have you provisioned a Cisco/Brocade/Juniper switch?

# VLAN Creation

- POL uses VLANs just like Ethernet switches

**Add Service to Port - It:1/1/1** ✕

Service

VLAN ID

Service Type

**Save**

Start	End	Count	ACL Mode	Bridge Type	MST ID	Registration Type	Description
300	1	1	Disable All ACLs	Full Bridging	CIST	Dynamic	CloudVLAN300
302	1	1	Disable All ACLs	Full Bridging	CIST	Dynamic	CloudVLAN302
304	1	1	Disable All ACLs	Full Bridging	CIST	Dynamic	CloudVLAN304
306	1	1	Disable All ACLs	Full Bridging	CIST	Dynamic	CloudVLAN306
308	1	1	Disable All ACLs	Full Bridging	CIST	Dynamic	MGMT
2001	2005	5	Disable All ACLs	Full Bridging	CIST	Dynamic	TIP_VLANS

Bridge Logical on Device core-0lt (192.168.50.22 : MXK-3U)

Select Physical  
 Vpn:  Vdr:

Select Physical Parts  
 Slot 1 - GPC14 - Running  
 Slot 6:7 - ACTIVE\_ETH-00 - Running  
 Slot a - UPLINK-2TG-8G - Running  
 Slot b - UPLINK-2TG-8G - Running

Traffic Info  
 Transmit Traffic Descriptor:    
 Receive Traffic Descriptor:    
 Encapsulation Type:    
 Multicast Control List:    
 Max Number of Multicast Streams:   
 Is PPPoA:  False  True

Bridge Logical Type  
 Use Templates  
 Bridge Type:   
 Type:   
 VLAN ID(L-4090):   
 Increment VLANid  secure  STP  
 Translate  QinQ  QoS  
 VLAN Class-Of-Service:   
 Outgoing COS option:   
 Outgoing COS value:   
 Stagg Protocol Id:   
 SLAN / S-tag Id(L-4090):   
 S-tag COS:   
 S-tag Outgoing COS option:   
 S-tag Outgoing COS Value:   
 MVR Vlan Id:   
 MSTP Instance:   
 VLAN Translate From ID(L-4090):   
 SLAN Translate From ID(L-4090):   
 Use Existing Packet Rules  Use Packet Rule Template  
 Ingress Packet Rule Group Index:    
 Egress Packet Rule Group Index:    
 Name:

**Add**

# Uplink Provisioning

- Pick 1G and 10G Ethernet ports to connect to the core network

Start	End	Count	Interface	Force Forward	IGMP Proxy	Description
300	300	1	NET1 (Uplink)	<input type="checkbox"/>	<input type="checkbox"/>	
302	302	1	NET1 (Uplink)	<input type="checkbox"/>	<input type="checkbox"/>	
304	304	1	NET1 (Uplink)	<input type="checkbox"/>	<input type="checkbox"/>	
306	306	1	NET1 (Uplink)	<input type="checkbox"/>	<input type="checkbox"/>	
308	308	1	NET1 (Uplink)	<input type="checkbox"/>	<input type="checkbox"/>	MGMT
2001	2001	1	NET2 (Uplink)	<input type="checkbox"/>	<input checked="" type="checkbox"/>	Network-A (ONT-1)
2002	2002	1	NET2 (Uplink)	<input type="checkbox"/>	<input checked="" type="checkbox"/>	Network-B
2004	2004	1	NET2 (Uplink)	<input type="checkbox"/>	<input type="checkbox"/>	VoIP

Port Id	Type	Name	Admin Status	Oper Status
1-6-1-0	Ether	1-6-1-0	Up	Down
1-6-2-0	Ether	1-6-2-0	Up	Down
1-6-3-0	Ether	1-6-3-0	Up	Down
1-6-4-0	Ether	1-6-4-0	Down	Down
1-6-5-0	Ether	1-6-5-0	Up	Down
1-6-6-0	Ether	1-6-6-0	Up	Down
1-6-7-0	Ether	1-6-7-0	Up	Down
1-6-8-0	Ether	1-6-8-0	Up	Down
1-6-9-0	Ether	1-6-9-0	Up	Down
1-6-10-0	Ether	1-6-10-0	Up	Down
1-6-11-0	Ether	1-6-11-0	Up	Down
1-6-12-0	Ether	1-6-12-0	Up	Down
1-6-13-0	Ether	1-6-13-0	Up	Down
1-6-14-0	Ether	1-6-14-0	Up	Down
1-6-15-0	Ether	1-6-15-0	Up	Down
1-6-16-0	Ether	1-6-16-0	Up	Down
1-6-17-0	Ether	1-6-17-0	Up	Down
1-6-18-0	Ether	1-6-18-0	Up	Down
1-6-19-0	Ether	1-6-19-0	Up	Down

OLT > Detected\_at\_135.249.41.109

Slot No	Cards	Card Type	Status	Alarms	Actions
0	NT IO	NGFC-H			<a href="#">Accept</a>
1	NT A	FANT-F		<span style="color: red;">9</span>	
2	EMPTY slot				
3	EMPTY slot				

# Uplink LAGs

- Add individual ports to Link Aggregation Groups
- Configure LACP

5571 POL Command Center

ONTs Services OLTs Metrics

Search for ...

admin

NT A

OLT > Detected\_at\_135.249.41.109 > NT A

Ports Alarms

Ports	Status	Alarms
LAG 5	No Service	1
LAG 10	No Service	1
nt-a.xfp:2	UP	1
lt:1/1/1	UP	0

Uplink Interface Property

Configuration Status LACP Config. LACP Status

Interface AID: LAG1

Description: default

Module Type: SFP

Speed: Auto-1000 (1G)

Hashing Algorithm: Source and Destination MAC

Uplink Default Vlan: 1

Selected Links:

- MDS1-ESUA-1
- MDS1-ESUA-2

Total: 2

# ONT Discovery

- ONTs will notify the OLT when they are connected
- Administrator determines next steps

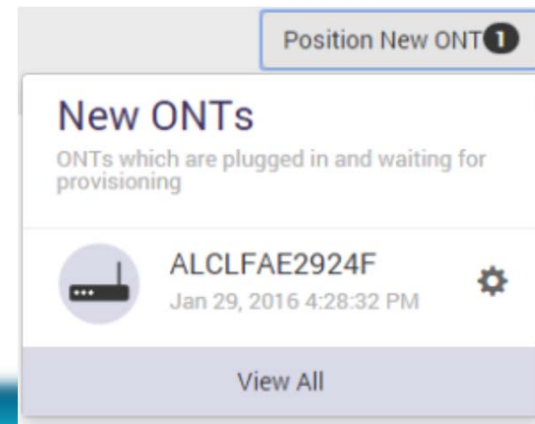
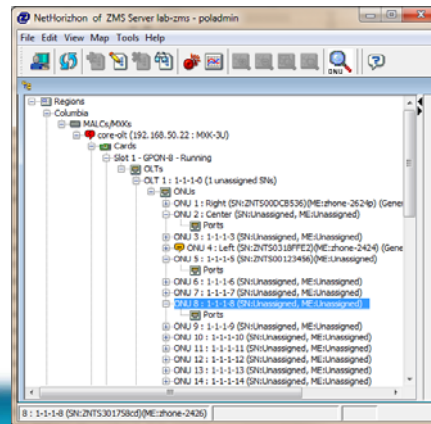
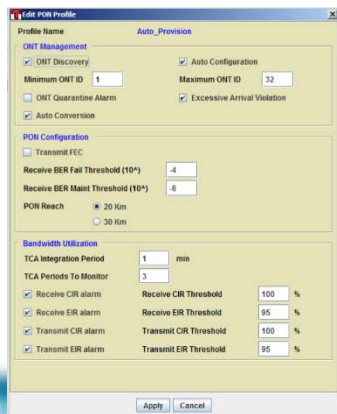

# ONT Ranging

- Know your ONT locations before they are deployed
- Assign a name and location as they are ranged

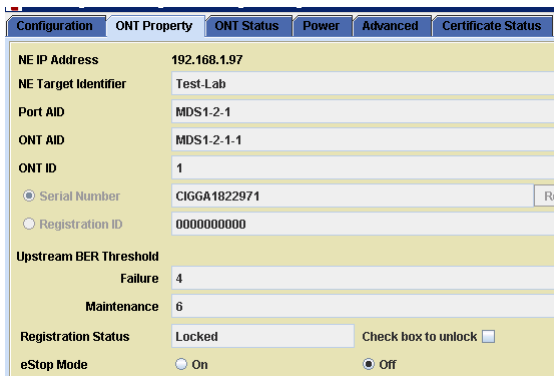

Configuration ONT Property ONT Status Power Advanced Certificate Status

NE IP Address	192.168.1.97
NE Target Identifier	Test-Lab
Port AID	MDS1-2-1
ONT AID	MDS1-2-1-1
ONT ID	1
<input checked="" type="radio"/> Serial Number	CIGGA1822971
<input type="radio"/> Registration ID	000000000
Upstream BER Threshold	
Failure	4
Maintenance	6
Registration Status	Locked <input type="checkbox"/> Check box to unlock
eStop Mode	<input type="radio"/> On <input checked="" type="radio"/> Off

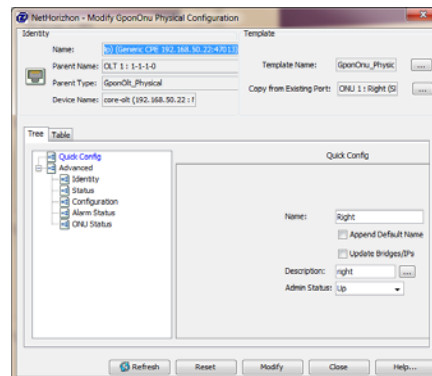

NetHORIZON - Modify GponOnu Physical Configuration

Name:	NJ [Server: ONU 192.168.50.22:4011]	Template:	GponOnu_Physic
Parent Name:	OLT 1: 1-1-1-0	Copy from Existing Port:	ONU 1: Right (S)
Parent Type:	GponOnu_Physical		
Device Name:	core-olt (192.168.50.22:1)		

Tree Table

Quick Config	Quick Config
Advanced	Name: right
Identity	<input type="checkbox"/> Append Default Name
Status	<input type="checkbox"/> Update Bridges/Ports
Configuration	Description: right
Alarm Status	Admin Status: Up
ONU Status	

Buttons: Refresh, Reset, Modify, Close, Help...





# ONT Provisioning

- Assign VLANs once ONTs are ranged

**Create Ethernet Port Service Profile**

Profile Name: VulP\_150

Service Type: Bridged NN

Class of Service: net.VBR

802.1p Marking Mode: COPY

Marked 802.1p Priority: 6

Network VLAN: 150

Subscriber VLAN: 150

Service Protocol: Transparent

Rate: Shaping Mode: Disable

Downstream Peak Rate: 1000102 Kbps

Upstream Peak Rate: 5120 Kbps

LLDP DSCP: 0

ACL Profile: StickyMAC\_2

**Add ONT port to service**

ALCL

ONT Detected\_at\_135.249.41.109.R1.S1.LT7.PON1.ONT1  
Serial No : ALCLFAE2924F  
Description:

ONT Detected\_at\_135.249.41.109.R1.S1.LT7.PON1.ONT2  
Serial No : ALCLFAE291C3  
Description:

Cancel

**NetHorizon - CPE Connection On Device**

Select GEM Port: Slot 1 - GPON-0 - Running

Bridge Logical: Select Bridge Template: Transparent LANSingleTa

Name: [ ]

VLAN ID (0..4090): 50

VLAN COS: 0

SLAN ID (1..4090): 0

SLAN COS: 0

SLAN TP ID: 0x8100

MVR VLAN: 0

GTP Information: Use GTP Index

CPE Connection: Type: Ethernet UNI

UNI Port: 1

UNI VLAN: 0

UNI SLAN: 0

UNI SLAN COS: 0

UNI SLAN TPID: 0x8100

DSCP To Cos Index: 0

RG Mode: Bridged

# Optical Levels

- OLTs and ONTs will report optical transmit and receive levels
- Provides basic indication of connection problems
- Not intended to replace cable plant certification

# Type-B Protection

- Provides sub-80ms switchover protection between PON ports on same OLT
- Redundant OLTs an option
- Switchover between OLTs  
*sometimes* requires re-ranging

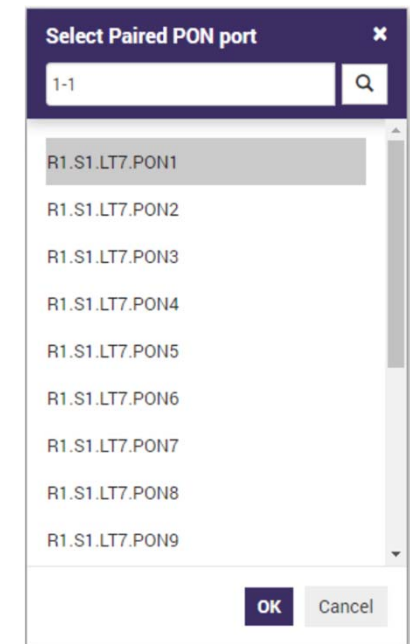
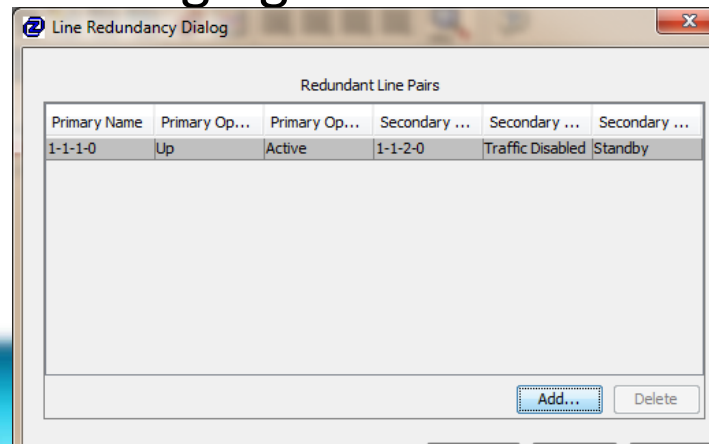

# OMCI

- OLTs communicate with ONTs using ONT Management and Control Interface (OMCI)
- OMCI is part of the GPON standard and operating outside of GEM Ports
- OMCI is established after ONT is ranged

# Bandwidth Assignment

- Bandwidth management is built-in to the GPON standard
- Required during provisioning

Upstream Bandwidth Profile		
CIR	AIR	EIR
<input type="text" value="0"/>	<input type="text" value="2000"/>	<input type="text" value="120000"/>

Downstream Bandwidth Profile	
CIR	EIR
<input type="text" value="2048"/>	<input type="text" value="120000"/>

# Bandwidth Management

Committed rates cannot exceed capacity of any link in the system

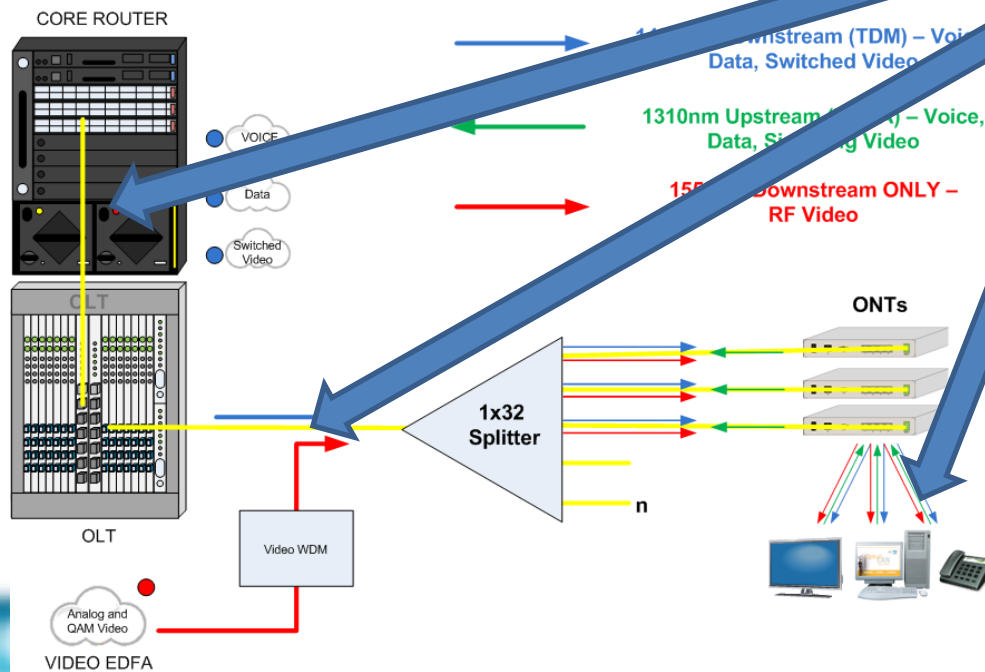

# Upstream Granting

- The “Grant” is the permission sent from the OLT to the ONT to:
  - Allow the ONT to transmit traffic in its assigned timeslot on the Upstream data train
  - Control the flow of Upstream traffic from the ONTs to the OLT so collisions of traffic from different ONTs on the PON do not occur

# Traffic Flow

Internal switching separates POL from carrier PON vendors

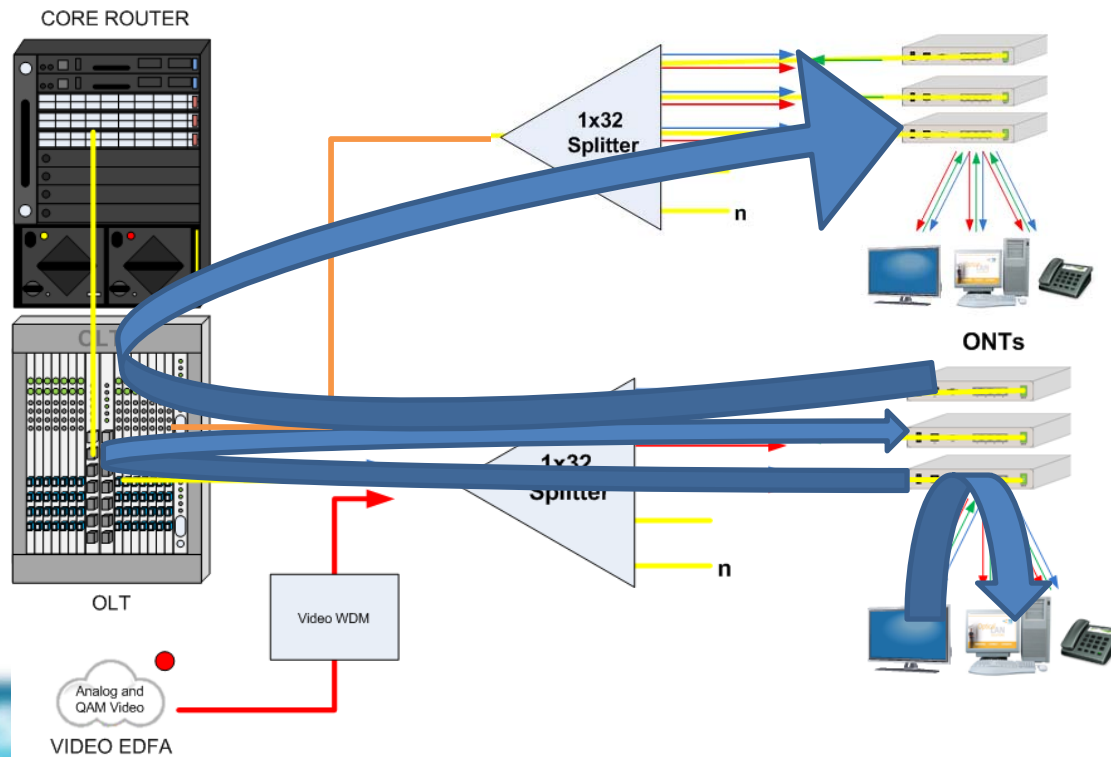

1. Within ONT
2. Within PON Card
3. Within OLT



# GPON Encapsulation

- VLANs mapped to GEM Ports
- GEM Ports assigned to traffic containers
- GEM Ports mapped to ONTs

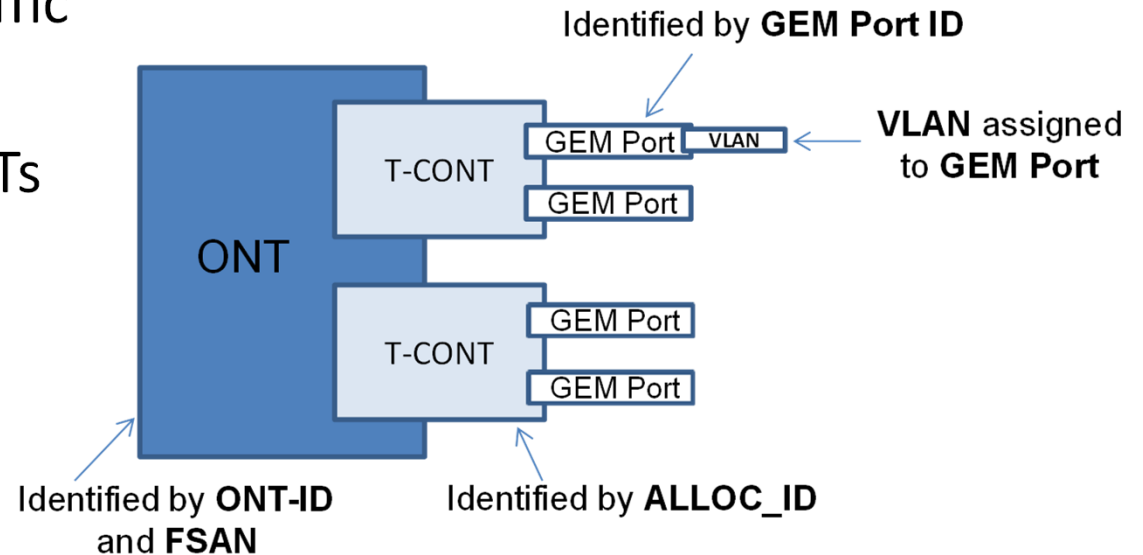

# Tagging, LLDP, PoE, QoS

- Tag VLANs from ONT
- Deliver power
- Configure connected devices with LLDP
- Customize QoS

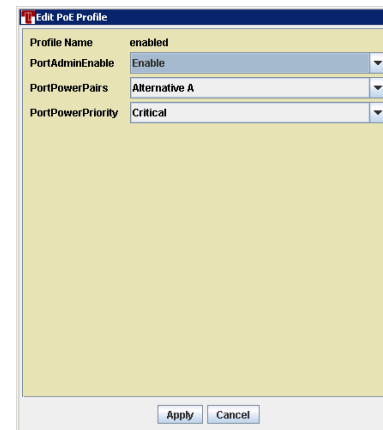

# STP & Loop Detection

- Full STP is not required in POL networks
- Loop detection is important

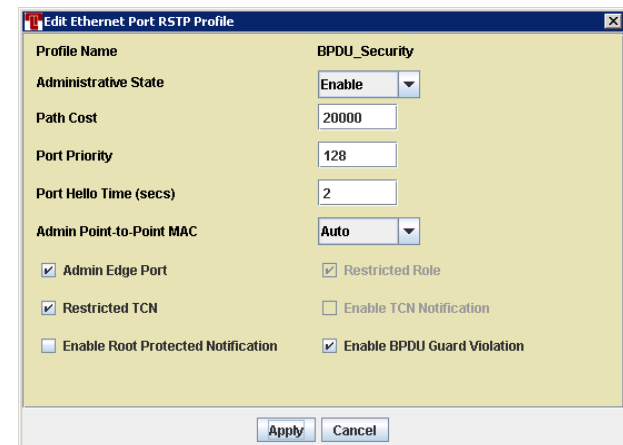

The screenshot shows a configuration window titled "Edit Ethernet Port RSTP Profile" with a close button in the top right corner. The window contains the following settings:

Field	Value
Profile Name	BPDU_Security
Administrative State	Enable
Path Cost	20000
Port Priority	128
Port Hello Time (secs)	2
Admin Point-to-Point MAC	Auto
<input checked="" type="checkbox"/> Admin Edge Port	<input checked="" type="checkbox"/> Restricted Role
<input checked="" type="checkbox"/> Restricted TCN	<input type="checkbox"/> Enable TCN Notification
<input type="checkbox"/> Enable Root Protected Notification	<input checked="" type="checkbox"/> Enable BPDU Guard Violation

At the bottom of the window are "Apply" and "Cancel" buttons.

# Multicast

- Multicast compliments PON topology
- OLTs and ONTs feature IGMP snooping
- Specific multicast VLAN required

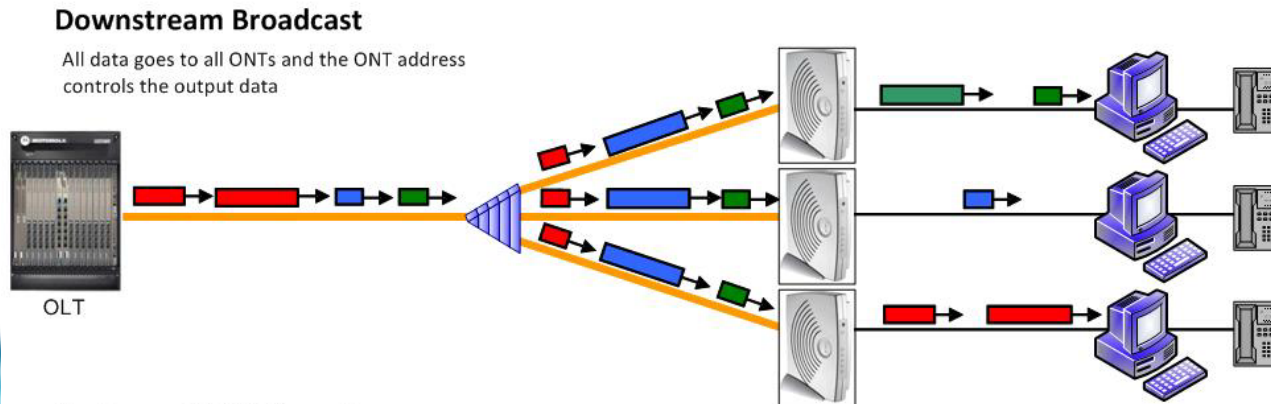

# Templates & Profiles

- Templates and profiles allow admins to create common settings

The image displays a network management interface with several overlapping windows. On the left, a tree view shows a network hierarchy: Network > Test-Lab > 1134 MSAP > 01 4xGPON > 02 4xGPON > 01 PON > 01 Test... > 02 PON > 03 PON > 04 PON > 03 4xGPON > 04 4xGPON > 05 4xGPON. A 'Ports' window is open, showing a table of interfaces:

AID	U
ETH1-2-1-1-1	
ETH1-2-1-1-2	
ETH1-2-1-1-3	
ETH1-2-1-1-4	

The 'Create New Service' dialog is open, showing the following fields:

- Service Name: [Empty]
- Service Type: HSL\_VPLS
- Description: [Empty]
- Max Mac Address: 16
- User to User Traffic: [Checked]
- Option82: [Checked]
- 802.1x Authentication: [Checked]
- Upstream Bandwidth Profile: CIR: 0, AIR: 2000, EIR: 120000
- Downstream Bandwidth Profile: CIR: 2048, EIR: 120000

The 'Identity' dialog is open, showing the following fields:

- Name: Spon Traffic Profile
- Parent Name: core-olt (192.168.50.22 : MXK-3U)
- Parent Type: Mx3U\_Device
- Profile Index: 0
- Traffic Class: cbr
- Compensated: [False]
- Shared: [False]
- Dynamic Bandwidth Allocation: [False]
- Guaranteed Upstream Bandwidth (in Kbps): 0
- Fixed Upstream UBR Bandwidth (in Kbps): 0
- Fixed Upstream CBR Bandwidth (in Kbps): 0
- Assured Upstream Bandwidth (in Kbps): 0
- Maximum Upstream Bandwidth (in Kbps): 0
- Extra Upstream Bandwidth Type: [Best Effort]

A table at the bottom right shows configuration details:

PAE	NAC	LLDP	Admin State	Status
default	Data_VoIP-200_250	LLDP_Enabled	Enabled	Modified
default	default	default	Disabled	
default	default	default	Disabled	
default	default	default	Disabled	

Services will be deployed on OLT when you associate ont port or configure an uplink port of the OLT

# Rules & Auto-Port Provisioning

- Auto-provision ONTs upon detection
- Set rules or selectors based upon ONT properties (location, model, etc.)
- Copy Configurations

The screenshot displays the 5571 POL Command Center interface. The main window shows the 'Edit ONT details' page for an ONT with ID 'INES-80-1-1-1-R1-S1-LT4-PON7-ONT1'. The ONT is acknowledged and has a serial number of 'ALCLF3897305'. The hardware type is 'G-240G-A'. The location is 'Level 1'. The ONT is unlocked and has an active S/W version of '3FE5630ADB19 (R05.02.00 SIP)'. The 'Ports' section shows a table with one port: 'PORT 1-1' with a 'Test Link' button. A 'Clipboard buffer' notification indicates that the configuration for 'ONT INES-80-1-1-1-R1-S1-LT4-PON7-ONT1' has been copied to the clipboard.

Overlaid on the main window is a 'Create Equipment Selector' dialog box. The 'Selector Name' is 'Slot-2\_PON-3\_709ONs\_Port1'. The 'ONT Type' is 'ONT709'. The 'AID Range' section includes: 'AID Type' set to 'Port', 'I/O Slot' set to '2', 'PON' set to '3', 'ONT' set to '^', and 'Port' set to '1'. A 'Copy Configuration' button is visible in the top right corner of the dialog box.

# Converging Standards

- IEEE and ITU working to converge standards in future generations
- 10G EPON and XGPON use same PHYs

# Future Standards

- EPON/GPON Networks can co-exist on the same fiber & splitters as 10G EPON/XGPON Networks
- 10G EPON and XGPON use same PHYs
- IEEE and ITU working to converge standards in future generations
- Next standards may combine multiple wavelengths in each direction for additional bandwidth



# Complimentary Wavelengths

## EPON/GPON

1490nm Down / 1310nm Up

## 10G EPON/XGPON

1577nm Down / 1270nm Up

## RF Video

1550nm Down

# Migration to 10G

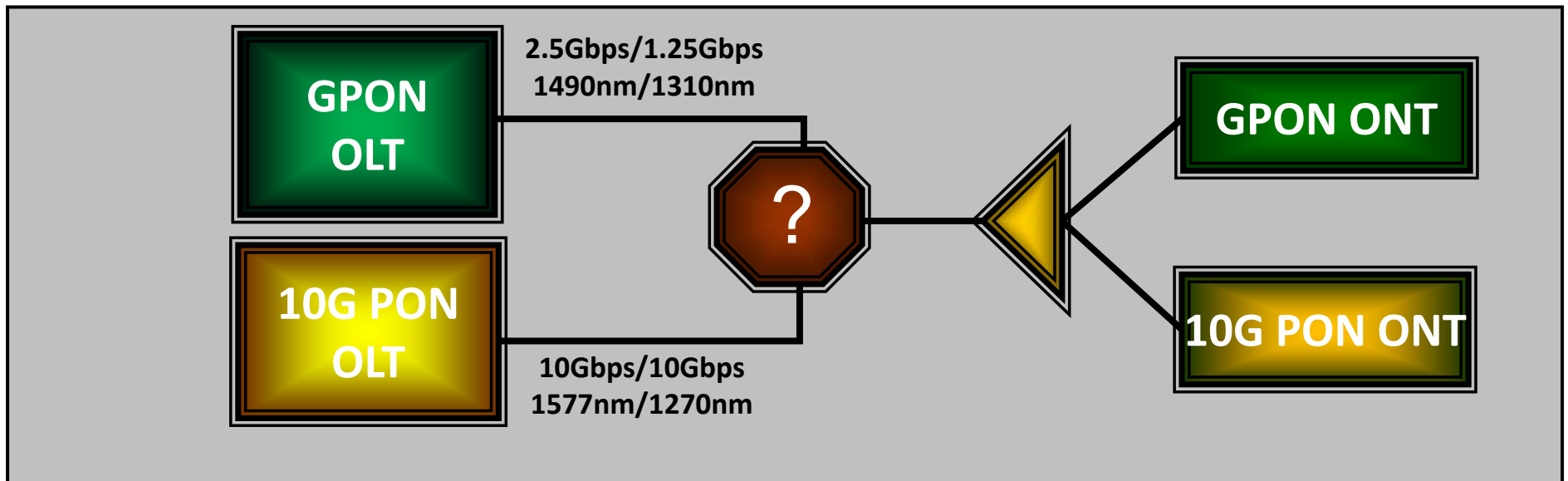

8

- 10G PON can coexist on the same fiber as GPON
- Bandwidths available as 10G Downstream and 10G/2.5G/1G Upstream
- Uses same infrastructure/splitters as GPON
- Casual migration – upgrade only the ONTs that you want

# The Migration to 10 & 40G PON

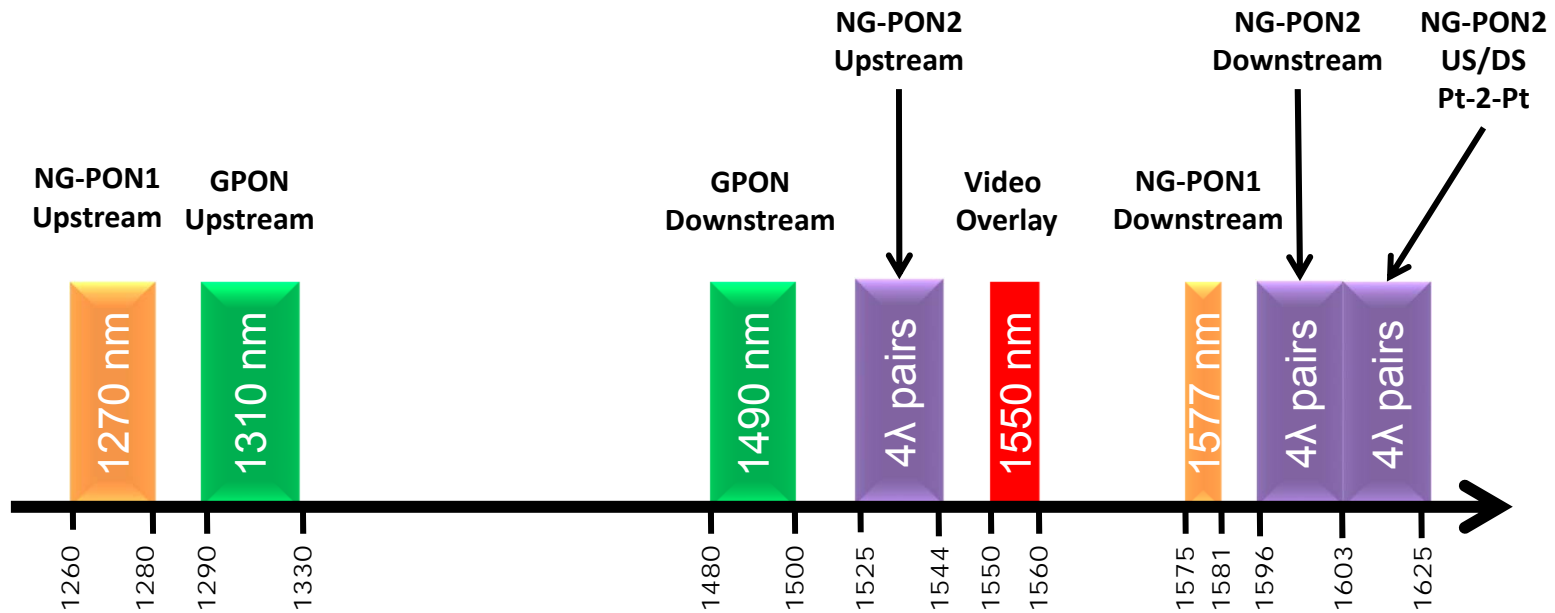

The cabling infrastructure stays the same and only the users that need it are upgraded.

PON Name	Version	DOWN (Gbps)	UP (Gbps)	Industry Standard
G-PON		2.5	1.25	ITU G.984
NG-PON1	XG-PON	10	2.5	ITU G.987
	XGS-PON	10	10	ITU G.9807
NG-PON2		40	40	ITU G.989

# Questions?

## Passive Optical LAN Integration & Management

Matt Miller  
AECOM



# POL Project Closeout Package

Chad Hines  
IT Connect



# Suggested Contents

- Rack Elevation Drawings
- As-Built Drawings
- Interconnect Documentation
- Test Results
- Datasheets and Documentation

# Rack Elevation Drawings

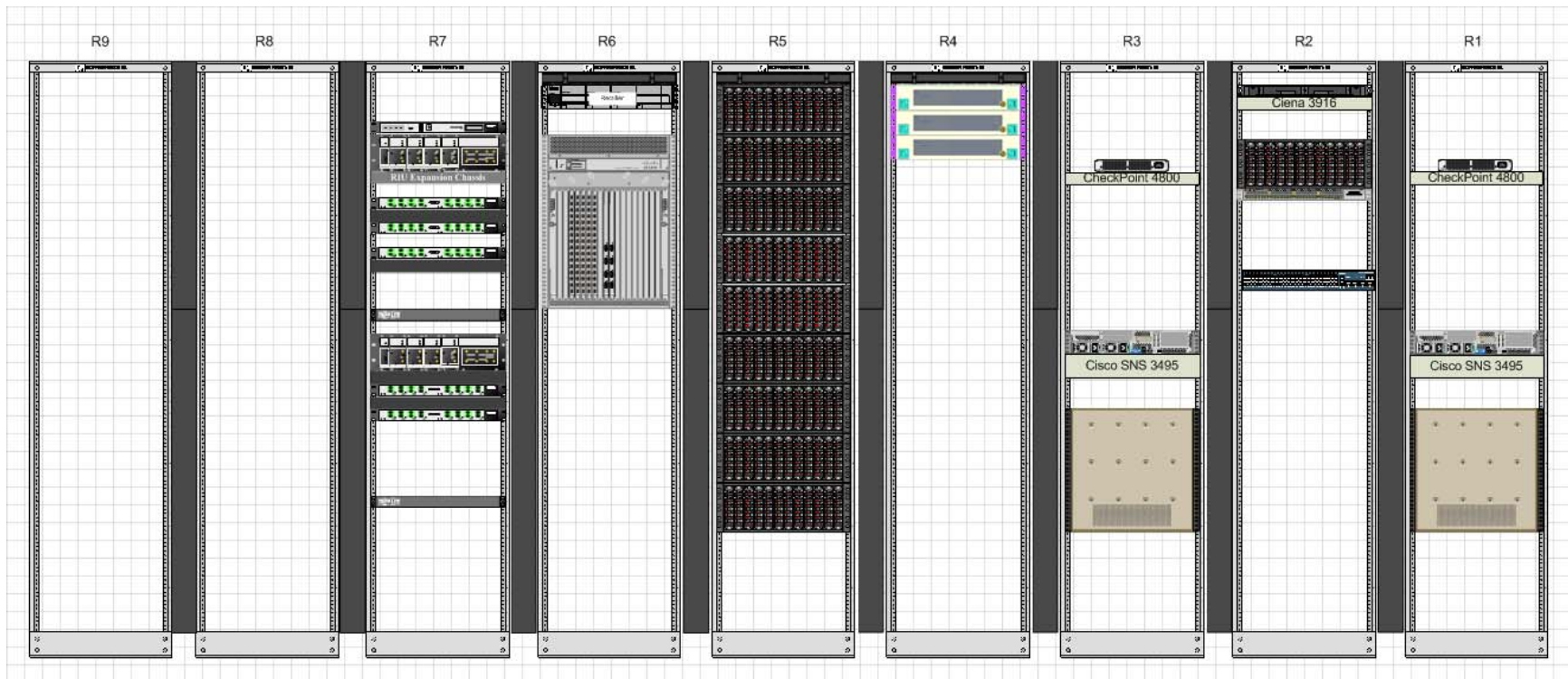

# As-Built Drawings

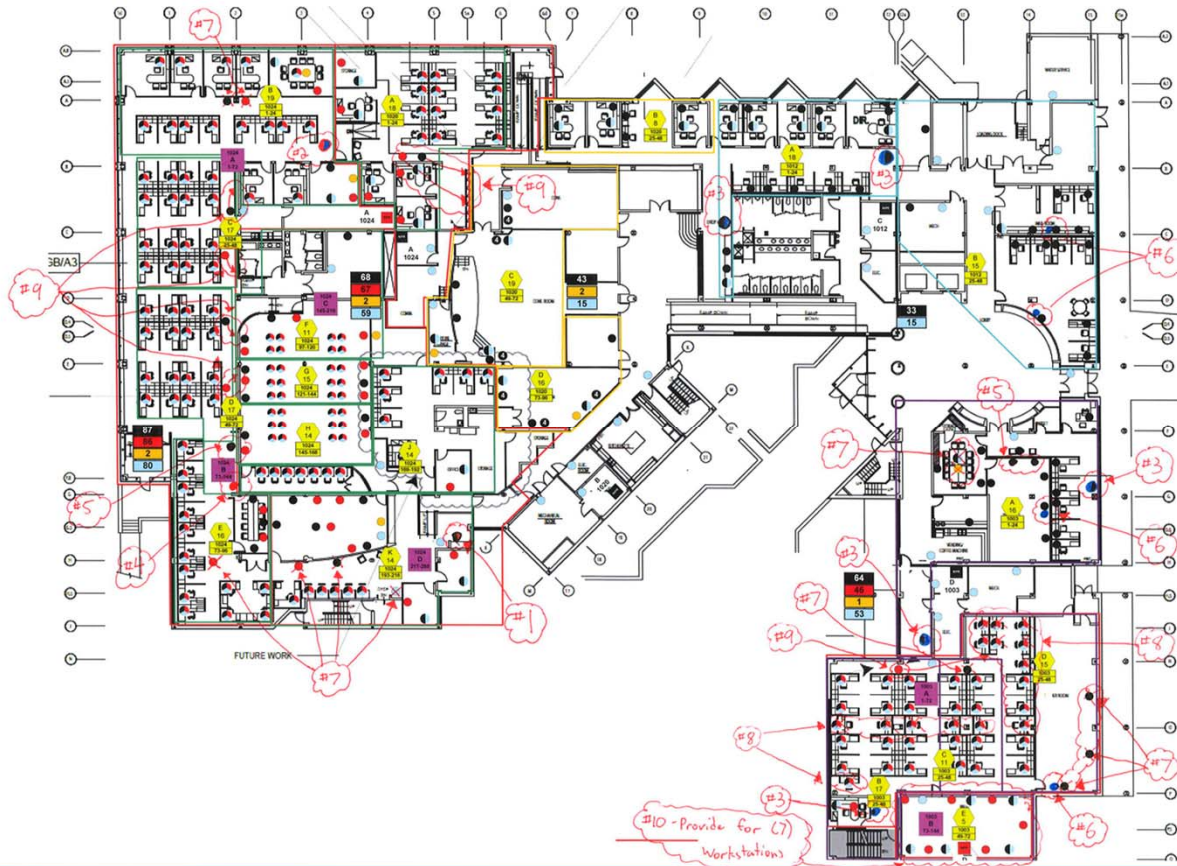



# Interconnect Documentation

Site	Building	OLT Rack	OLT Chassis	PON Card	PON Port	VAM Shelf	VAM Module	VAM Port	Backbone Shelf	Riser Cable	Backbone Port
Las Vegas	Mandalay Bay	MDF Rack 6	ManBay001	4	16	1	8	2	2	2	1
Las Vegas	Mandalay Bay	MDF Rack 6	ManBay001	4	16	1	8	2	2	2	1
Las Vegas	Mandalay Bay	MDF Rack 6	ManBay001	4	16	1	8	2	2	2	1
Las Vegas	Mandalay Bay	MDF Rack 6	ManBay001	4	16	1	8	2	2	2	1
Las Vegas	Mandalay Bay	MDF Rack 6	ManBay001	4	16	1	8	2	2	2	1
Las Vegas	Mandalay Bay	MDF Rack 6	ManBay001	4	16	1	8	2	2	2	1
Las Vegas	Mandalay Bay	MDF Rack 6	ManBay001	4	16	1	8	2	2	2	1
Las Vegas	Mandalay Bay	MDF Rack 6	ManBay001	4	16	1	8	2	2	2	1
Las Vegas	Mandalay Bay	MDF Rack 6	ManBay001	4	16	1	8	2	2	2	1
Las Vegas	Mandalay Bay	MDF Rack 6	ManBay001	4	16	1	8	2	2	2	1
Las Vegas	Mandalay Bay	MDF Rack 6	ManBay001	4	16	1	8	2	2	2	1
Las Vegas	Mandalay Bay	N/A	N/A	N/A	N/A	N/A	N/A	N/A	N/A	N/A	N/A



# Interconnect Documentation

FDH	FDH Location	Splitter	Splitter Fiber	FDH Port	RDT	RDT Port Count	RDT Location	RDT Port	Drop #	Room Number	ONT Model	ONT SN#
MB1	3rd floor mechanical room across from 313	1	1	1	1	1-12	Located in front of 115	1	1	GUEST RM 2	ONT 123	90D7B
MB1	3rd floor mechanical room across from 313	1	2	2	1	1-12	Located in front of 115	2	2	120	ONT 123	90F2F
MB1	3rd floor mechanical room across from 313	1	3	3	1	1-12	Located in front of 115	3	3	119	ONT 123	90D75
MB1	3rd floor mechanical room across from 313	1	4	4	1	1-12	Located in front of 115	4	4	116	ONT 123	910D4
MB1	3rd floor mechanical room across from 313	1	5	5	1	1-12	Located in front of 115	5	5	117	ONT 123	90F49
MB1	3rd floor mechanical room across from 313	1	6	6	1	1-12	Located in front of 115	6	6	114	ONT 123	90FCF
MB1	3rd floor mechanical room across from 313	1	7	7	1	1-12	Located in front of 115	7	7	115	ONT 123	9130E
MB1	3rd floor mechanical room across from 313	1	8	8	1	1-12	Located in front of 115	8	8	113	ONT 123	90D72
MB1	3rd floor mechanical room across from 313	1	9	9	1	1-12	Located in front of 115	9	9	112	ONT 123	910C6
MB1	3rd floor mechanical room across from 313	1	10	10	1	1-12	Located in front of 115	10	10	111	ONT 123	90E09
MB1	3rd floor mechanical room across from 313	1	11	11	1	1-12	Located in front of 115	11	11	118	ONT 123	90F08
MB1	3rd floor mechanical room across from 313	N/A	N/A	12	1	1-12	N/A	12	Spare	N/A	N/A	N/A

# Interconnect Documentation

ONT GE Port 1 Device	ONT GE Port 1 MAC	ONT GE Port 2 Device	ONT GE Port 2 MAC	ONT GE Port 3 Device	ONT GE Port 3 MAC	ONT GE Port 4 Device	ONT GE Port 4 MAC	ONT POTS Port 1	ONT POTS Port 2	RF Port	WAP MACs	Notes
Active	N/A	N/A	N/A	N/A	N/A	N/A	N/A	Active	N/A	N/A	N/A	N/A
Active	N/A	N/A	N/A	N/A	N/A	WAP	F40F1B7E0CF8	Active	N/A	N/A	F40F1B7E0CF8	N/A
Active	N/A	N/A	N/A	N/A	N/A	N/A	N/A	Active	N/A	N/A	N/A	N/A
Active	N/A	N/A	N/A	N/A	N/A	N/A	N/A	Active	N/A	N/A	N/A	N/A
Active	N/A	N/A	N/A	N/A	N/A	N/A	N/A	Active	N/A	N/A	N/A	N/A
Active	N/A	N/A	N/A	N/A	N/A	N/A	N/A	Active	N/A	N/A	N/A	N/A
Active	N/A	N/A	N/A	N/A	N/A	WAP	F40F1B7F2B34	Active	N/A	N/A	F40F1B7F2B34	N/A
Active	N/A	N/A	N/A	N/A	N/A	N/A	N/A	Active	N/A	N/A	N/A	N/A
Active	N/A	N/A	N/A	N/A	N/A	WAP	F40F1B6373D8	Active	N/A	N/A	F40F1B6373D8	N/A
Active	N/A	N/A	N/A	N/A	N/A	N/A	N/A	Active	N/A	N/A	N/A	N/A
Active	N/A	N/A	N/A	N/A	N/A	WAP	88F0316C59B4	Active	N/A	N/A	88F0316C59B4	N/A
N/A	N/A	N/A	N/A	N/A	N/A	N/A	N/A	N/A	N/A	N/A	N/A	N/A



# Test Results

## FasTesT Report

### General Information

Filename:	MandalayBay2.olts	Cable ID:	AP 2.0 - Mandalay Bay
Test date:	3/30/2015	Fiber ID:	FIBER001; FIBER002; FIBER003; FIBER004; FIBER005; FIBER006; FIBER007; FIBER008; FIBER009; FIBER010; FIBER011; FIBER012
Test time:	2:28 PM; 2:30 PM; 2:31 PM; 2:32 PM; 2:33 PM; 2:34 PM	Customer:	Mandalay Bay
Job ID:	AP 2.0 - Mandalay Bay	Company:	Sin City Cabling
Comments:			

### Location A

Location: Wayne Newton  
 Unit's model: FOT-932  
 Unit's s/n: 767843

### Location B

Location: Celine Dion  
 Unit's model: FOT-932  
 Unit's s/n: 774536

### FasTesT

Fiber ID	Wavelength (nm)	Loss A->B (dB)	Ref. A->B (dB)	Loss B->A (dB)	Ref. B->A (dB)	Average (dB)	ORL A->B (dB)	ORL B->A (dB)	Length (ft)
FIBER001	1310	0.39	N/A	1.30	N/A	0.82	42.59	40.05	N/A
FIBER002	1310	0.59	-1.26	0.63	0.87	0.61	42.30	41.61	2,112.7000
FIBER003	1310	0.52	-1.26	0.51	0.87	0.52	42.88	>42.52	2,111.3000
FIBER004	1310	0.37	-1.26	0.44	0.87	0.40	43.58	>42.37	2,115.6000
FIBER005	1310	0.34	-1.26	0.37	0.87	0.36	42.01	>42.25	2,113.2000
FIBER006	1310	1.74	-1.26	1.74	0.87	1.74	42.41	36.18	2,110.6000
FIBER007	1310	0.68	-1.26	0.81	0.87	0.75	38.39	34.97	2,109.1000
FIBER008	1310	0.54	-1.26	0.63	0.87	0.59	42.72	>42.76	2,105.7000
FIBER009	1310	1.51	-1.26	1.60	0.87	1.55	43.27	42.14	2,103.3000
FIBER010	1310	0.45	-1.26	0.56	0.87	0.51	43.54	>42.62	2,105.2000
FIBER011	1310	0.57	-1.26	0.61	0.87	0.59	43.38	42.61	2,107.7000
FIBER012	1310	1.24	-1.26	1.24	0.87	1.24	43.28	40.66	2,104.9000



# Datasheets and Documentation



Documentation  
and Datasheets

# Questions?

## POL Project Closeout Package

Chad Hines

IT Connect

Brought to you by the Association for Passive Optical LAN  
(APOLAN)

Platinum Members:

**AECOM**



**CORNING**

**DZS** | EVERY CONNECTION MATTERS™

**excel**  
without compromise.



**NOKIA**

**tellabs**

**ITCONNECT**



**HUAWEI**

[www.apolanglobal.org](http://www.apolanglobal.org)

**BICSI FALL**

**BICSI**